

SQUARE CORNER

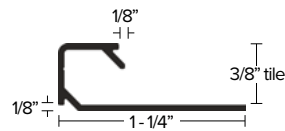

Q 38 **edgetek** Square Corner

PROVIDES PROTECTIVE EDGE WHILE TRANSITIONING 3/8" CERAMIC EDGE TO LESSER HEIGHT.

FINISH: EA, EN, BBDA, BRZ

Compare to: Q 80 AE, Q 80 AT, Q 80 ACG

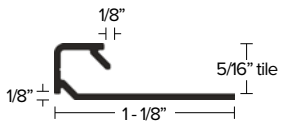

Q 516 **edgetek** Square Corner

PROVIDES PROTECTIVE EDGE WHILE TRANSITIONING 5/16" CERAMIC EDGE TO LESSER HEIGHT.

FINISH: EA, EN, BBDA, BRZ

Compare to: Q 100 AE, Q 100 AT, Q 100 ACG

METAL CORNERS

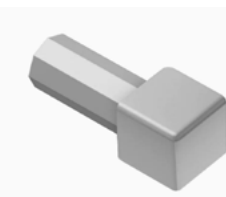

Q 38 Metal Corner

CREATES A 90° INSIDE OR OUTSIDE CORNER WHILE ELIMINATING THE NEED FOR A MITERED EDGE

FINISH: EA, EN, BRZ

FOR USE WITH **edgetek** Q 38 EA

Compare to: Q 100 AE, Q 100 AT

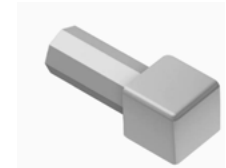

Q 516 Metal Corner

CREATES A 90° INSIDE OR OUTSIDE CORNER WHILE ELIMINATING THE NEED FOR A MITERED EDGE

FINISH: EA, EN, BRZ

FOR USE WITH **edgetek** Q 516 EA

Compare to: Q 80 AE, Q 80 AT

ROUND BULLNOSE

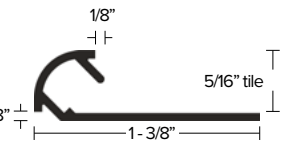

R 516 **edgetek** Bullnose

PROVIDES PROTECTIVE EDGE WHILE TRANSITIONING 5/16" CERAMIC EDGE TO LESSER HEIGHT.

FINISH: EA, EN, BBDA, BRZ

Compare to: RO 80 AE, RO 80 AT, RO 80 ACG

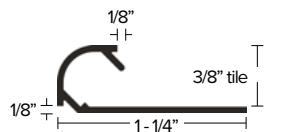

R 38 **edgetek** Bullnose

PROVIDES PROTECTIVE EDGE WHILE TRANSITIONING 3/8" CERAMIC EDGE TO LESSER HEIGHT.

FINISH: EA, EN, BBDA, BRZ

Compare to: RO 100 EA, RO 100 AT, RO 100 ACG



R 38 Metal Corner

CREATES A 90° OUTSIDE CORNER WHILE ELIMINATING THE NEED FOR A MITERED EDGE

FINISH: EA, EN, BRZ

FOR USE WITH **edgetek** R 38 EA

Compare to: RO 100 AE, RO 100 AT



R 516 Metal Corner

CREATES A 90° OUTSIDE CORNER WHILE ELIMINATING THE NEED FOR A MITERED EDGE

FINISH: EA, EN, BRZ

FOR USE WITH **edgetek** R 516 EA

Compare to: RO 80 AE, RO 80 AT

QUARTER ROUND

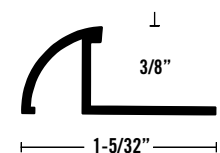

TQ 38 Quarter Round

PROVIDES PROTECTIVE EDGE FOR OUTSIDE CORNER WALLS AND FLOOR.

FINISH: EA, EN

Look for the **edgetek** logo to select trim featuring Edgetek feature.

ADA Compliance

Many of the trims and transitions offered by Futura Transitions are compatible with ADA 2010 Standards section 303 Changes in Level and section 504.5 Nosings. However, installers and contractors must insure that the finished installation, including any Futura Transitions product complies with current ADA standards when the project specifies an ADA requirement. [For more information on ADA standards visit https://www.ada.gov/2010ADAstandards_index.htm](https://www.ada.gov/2010ADAstandards_index.htm)

edgetek™

CREATING THE PERFECT GROUT LINE

EdgeTek™ has been engineered to create a perfect grout line by extruding a feature into the product that holds the tile the perfect distance from the reveal along the length of the trim. This allows you to create a perfectly straight grout line that looks great every time.

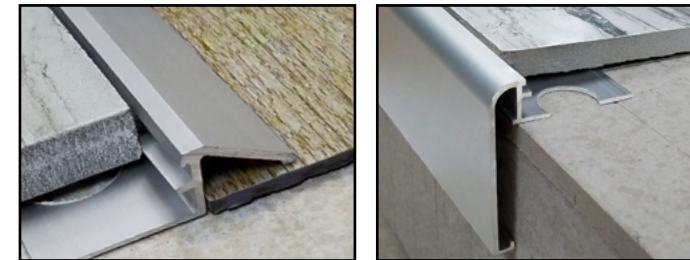

Etched Aluminum (EA)



Bright Dipped Brass (BDB)



WHITE



Etched Nickel (EN)



Etched Brass (EB)



Bright Dip Aluminum (BBDA)



PERGAMON



Etched Bronze (BRZ)



Etched Black (EBLK)

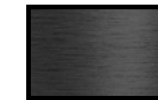

GREY



Look for the **edgetek** logo to select trim featuring Edgetek feature.

CERAMIC TRIMS, TRANSITIONS & NOSINGS

FUTURA TRANSITIONS

BY BONNELL ALUMINUM



www.futuratransitions.com
1.800.824.2049

972179/07/25

L-SHAPE

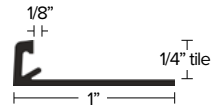

L 14 edgetek L Shape

PROVIDES PROTECTIVE EDGE FOR 1/4" CERAMIC.

FINISH: EA, EN

Compare to AE 60, A 60 AT

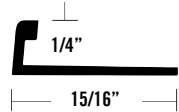

TT 14 L Shape

PROVIDES PROTECTIVE EDGE FOR 1/4" CERAMIC.

FINISH: EA, EN

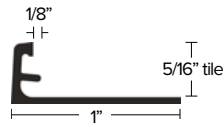

L 516 edgetek L Shape

PROVIDES PROTECTIVE EDGE FOR 5/16" CERAMIC.

FINISH: EA, EN, BRZ, EBLK, MF

Compare to: AE 80, A 80 AT, A 80 AGSG



TT 516 L Shape

PROVIDES PROTECTIVE EDGE FOR 5/16" CERAMIC.

FINISH: EA, EN, WHITE, PERGAMON, GREY

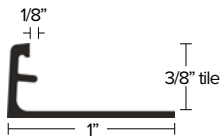

L 38 edgetek L Shape

PROVIDES PROTECTIVE EDGE FOR 3/8" CERAMIC.

FINISH: EA, EN, EB, BRZ, EBLK, MF

Compare To: AE 100, A 100 AT, A 100 AM, A 100 AGSG

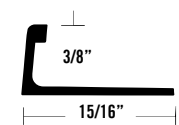

TT 38 L Shape

PROVIDES PROTECTIVE EDGE FOR 3/8" CERAMIC.

FINISH: EA, EN, WHITE, PERGAMON, GREY

Look for the **edgetek** logo to select trim featuring Edgetek feature.

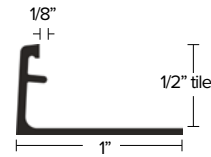

L 12 edgetek L Shape

PROVIDES PROTECTIVE EDGE FOR 1/2" CERAMIC.

FINISH: EA, EN, BRZ

Compare to: AE 125, A 125 AT

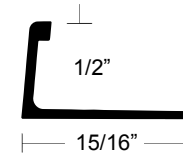

TT 12 L Shape

PROVIDES PROTECTIVE EDGE FOR 1/2" CERAMIC.

FINISH: EA, EN, EB, BDB, EBLK

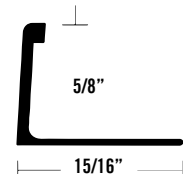

TT 58 L Shape

PROVIDES PROTECTIVE EDGE FOR 5/8" CERAMIC.

FINISH: EA

CARPET TUCK

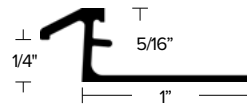

CT 516 edgetek Carpet Tuck

TRANSITIONS FROM 3MM LVT TO 5/16" TILE.

FINISH: EA, EN

Compare to: AETK 80, ATK 80 AT

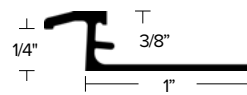

CT 38 edgetek Carpet Tuck

TRANSITIONS FROM 3MM LVT TO 3/8" TILE.

FINISH: EA, EN, BRZ

Compare to: AETK 100, ATK 100 AT

JOINERS

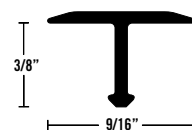

T 916 T - molding

JOIN CERAMIC OF SAME HEIGHT WHERE SEEM IS NEEDED. 3/8"IN BARBED LEG.

FINISH: EA

STAIR NOSING

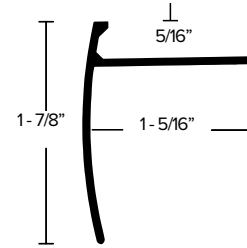

TS 516 Stair Nosing

PROVIDES FINISHED EDGE FOR STEPS OR COUNTERTOPS IN 5/16" CERAMIC.

FINISH: EN

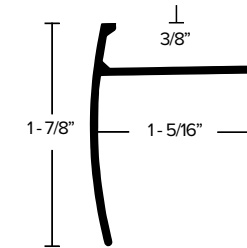

TS 38 Stair Nosing

PROVIDES FINISHED EDGE FOR STEPS OR COUNTERTOPS IN 3/8" CERAMIC.

FINISH: EA, EN

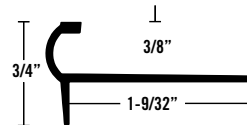

SE 38 Stair Nosing

PROVIDES FINISHED EDGE FOR STEPS OR COUNTERTOPS IN 3/8" CERAMIC.

FINISH: EA, EN

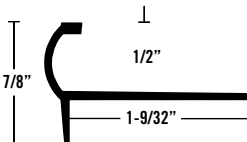

SE 12 Stair Nosing

PROVIDES FINISHED EDGE FOR STEPS OR COUNTERTOPS IN 1/2" CERAMIC.

FINISH: EA

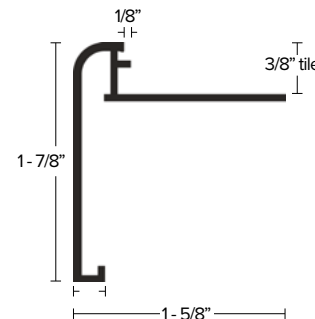

Step 38 edgetek Stair Nosing

PROVIDES FINISHED EDGE FOR STEPS OR COUNTERTOPS IN 3/8" CERAMIC.

FINISH: EA, BRZ

Look for the **edgetek** logo to select trim featuring Edgetek feature.

TILE REDUCERS



U 516 edgetek Reducer

PROVIDES PROTECTIVE EDGE WHILE TRANSITIONING 5/16" CERAMIC EDGE TO LESSER HEIGHT.

FINISH: EA, EN, EBRZ

Compare to: AEU 80, AU 80 AT

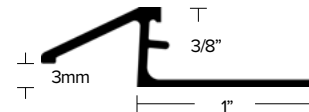

U 38 edgetek Reducer

PROVIDES PROTECTIVE EDGE WHILE TRANSITIONING 3/8" CERAMIC EDGE TO LESSER HEIGHT.

FINISH: EA, EN, BRZ

Compare to: AEU 100, AU 100 AT

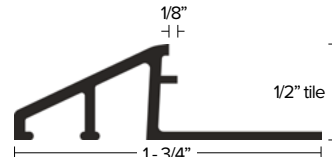

U 12 edgetek Reducer

PROVIDES PROTECTIVE EDGE WHILE TRANSITIONING 1/2" CERAMIC EDGE TO LESSER HEIGHT.

FINISH: EA, EN

Compare to: AEU 125, AU 125 AT

CERAMIC TO LVT

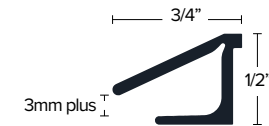

ETR 38 edgetek Tile to LVT

TRANSITIONS FROM EXISTING 1/2" TILE TO 3MM LVT +.

FINISH: EA, EN, BRZ

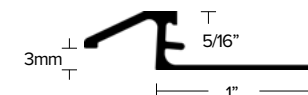

TLVT 516 edgetek Tile to LVT

TRANSITIONS FROM 3MM LVT TO 5/16" TILE.

FINISH: EA, EN



TLVT 38 edgetek Tile to LVT

TRANSITIONS FROM 3MM LVT TO 3/8" TILE.

FINISH: EA, EN, BRZ