



FUTURA

TRANSITIONS

by **Bonnell Aluminum**

COMMERCIAL & RESIDENTIAL TRIMS & TRANSITIONS CATALOG

July 2024

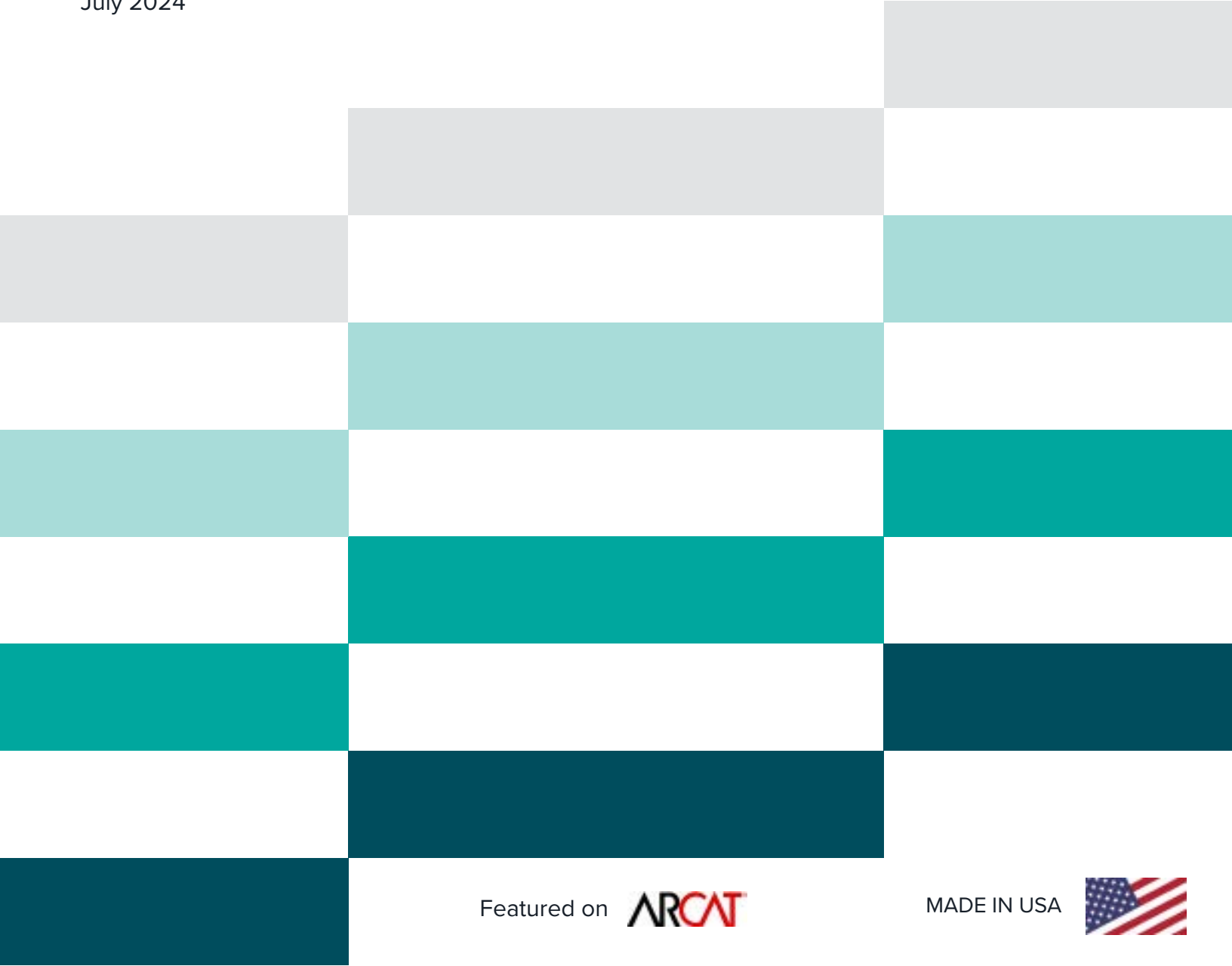

Featured on **ARCAT**

MADE IN USA



TRANSITION FINDER

| Material Height | Bare Floor | 2.5mm | 3mm | 3.5mm | 4mm | 4.5mm | 5mm | 6mm | 7mm | 8mm | 14mm | 15mm | Carpet Tile / Glue Down | Ceramic Tile |
|-------------------------|----------------------------|--------|--------------------------------------|--------|--------|--------|----------------------------|--------|--------|--------|--------|--------|--------------------------------------|----------------------------|
| Bare Floor | | LVT425 | LVT113 LVT406 LVT303 | | | | LVT115 | | | | | | LVT160 LVT115 | |
| 2.5mm | LVT425 | LVT102 | LVT128 | LVT123 | | LVT124 | | | LVT129 | | | LVT126 | LVT124 | |
| 3mm | LVT113 LVT406 LVT303 | LVT128 | LVT103 LVT102 LVT133 | | | LVT125 | LVT127 LVT350 | | | | | | LVT125 LVT130 LVT131 LVT350 | ETR38 TLVT516 TLVT38 |
| 3.5mm | | LVT123 | | | | | | | | | | | | |
| 4mm | | | | | LVT102 | | | | | | | | LVT904 | |
| 4.5mm | | LVT124 | LVT125 | | | | | | LVT121 | | | LVT120 | | |
| 5mm | LVT115 | | LVT127 LVT350 | | | | LVT105 LVT102 LVT155 | | | | | | LVT150 LVT905 | |
| 6mm | | | | | | | | LVT102 | | | LVT119 | | | |
| 7mm | | LVT129 | | | | LVT121 | | | LVT102 | | | LVT122 | | |
| 8mm | | | | | | | | | | LVT102 | | | | |
| 14mm | | | | | | | | LVT119 | | | | | | |
| 15mm | | LVT126 | | | | LVT120 | | | LVT122 | | | LVT102 | | |
| Carpet Tile / Glue Down | LVT160 LVT115 | LVT124 | LVT125 LVT130 LVT131 LVT350 | | LVT904 | | LVT150 LVT905 | | | | | | LVT105 | |
| Ceramic Tile | | | ETR38 TLVT516 TLVT38 | | | | | | | | | | | |

*48 HOUR GUARANTEE



Items listed with the 48 Hour Guarantee icon are guaranteed to ship from the factory to the distributor in 48 hours or less from the time a purchase order is received and we ship the product. 48 Hour Guarantee does not apply if ordering more than your average number of pieces within the last 6 month period.

Trims and Transitions for Commercial and Residential Flooring and Wall Projects



Futura Industries has long been the market leader and producer of luxury aluminum trims and transitions for most flooring types in both commercial and residential settings. Originally known as Colotrym in the 1950s and largely focused on solutions for stretch carpet we made being number one in quality, value and service to our customers our top priority. In 1964, Colotrym became Futura and we spent the next 55 years adding innovative solutions to our product line including trims and transitions for ceramic installations as well as LVT and resilient flooring. In 2017, Futura was purchased by Bonnell Aluminum, one of the largest domestic manufacturers of extruded aluminum.

We are proud to reveal our new logo and updated name, **Futura Transitions**. The logo colors pay homage to our past, present and future while communicating our determination to create innovative solutions for our customers. The definition of transition is “the process of changing from one state or condition to another.” Our flooring products don’t just transition from one flooring product to another. They change decorative trim to durable and sustainable luxury edge protection. They take an installation challenge and transform it into a feature that compliments the entire space. In short, using Futura Transitions flooring products transitions a flooring project from average to remarkable!

Futura Transitions products are sold through trusted pro-channel distributors in the US and Canada who count on exceptional customer service, consistent lead times and the 48 hour guarantee* offered on our most popular products. Our aluminum transitions and trims are manufactured in the USA and are available in a variety of premium finishes and sizes that compliment current trends in fixtures and flooring styles.

For more information visit us at www.futuratransitions.com or call 1.800.824.2049 to find a distributor near you.

Architects / Designers / Engineers / Facility Managers



ARCAT PHILOSOPHY: "To publish quality products for architects, engineers and specifiers to enable them to easily specify ARCAT building product manufacturer clients." ARCAT is the leading online resource of free building product information. With a CAD library of over 7000 product lines ARCAT provides architects, engineers and designers the ability to find the products they need for their projects. **Visit www.arcat.com and search for Futura Transitions today!**

ADA COMPLIANCE

Many of the trims and transitions offered by Futura Transitions are compatible with ADA 2010 Standards section 303 Changes in Level and section 504.5 Nosings. However, installers and contractors must ensure that the finished installation, including any Futura Transitions product complies with current ADA standards when the project specifies an ADA requirement. **For more information on ADA standards visit https://www.ada.gov/2010ADASTANDARDS_INDEX.HTM**

CONTENTS

► CATALOG INFORMATION

| | |
|--|--------|
| Commercial & Residential Trim Finder | 2 |
| Aluminum Finishes | 7 |
| New Products | 8 - 13 |

► WARRANTY

| | |
|--|-----|
| Warranty, material and maintenance information | 107 |
|--|-----|

► CARPET METAL TRIMS

| | |
|---|----|
| 1/2" Standard Pin Clampdown (CM 104, CM3703, CM 3703 Flex) | 15 |
| 9/16" Standard Pin Clampdown (CM 95, CM 12-2114, CM 12-2117, CM 12-2118) | 15 |
| 1/2" Premium Pin Clampdown (CM 102, CM 106 Flex) | 16 |
| 9/16" Premium Pin Clampdown (CM 101, CM 105 Flex, CM 3705, CM 3705 Flex) | 16 |
| 5/8" Premium Pin Clampdown (CM 100, CM 109 Flex) | 16 |
| 11/16" Premium Pin Clampdown (CM 3704) | 16 |
| 3/4" Premium Pin Clampdown (CM 99A, CM 107A Flex) | 17 |
| 3/4" Deluxe Pin Clampdown (CM 99, CM 107 Flex, CM 654, CM 654 Flex) | 17 |
| 1" Commercial Pin Clampdown (CM 103) | 17 |
| 1/2" Premium Pinless Clampdown (CM 201, CM205 Flex) | 18 |
| 9/16" Deluxe Pinless Clampdown (CM 211, CM 211 Flex) | 18 |
| 11/16" Blank Clampdown for Tack Strips (CM 121) | 19 |
| Carpet Tile Joiner (CM 308) | 19 |
| 1 1/2" Joiner with Pins (CM 108) | 19 |
| 1 12/32" Pinless Joiner (CM 208) | 20 |
| 1 9/16" Joiner with Pins (CM 112) | 20 |
| 1 1/2" Pinless Joiner (CM 212) | 20 |
| 1 3/8" Vinyl Insert Carpet Metal with Pins (CM 110, CM 110 Flex) | 20 |
| 1 9/16" Vinyl Insert Carpet Metal with Pins (CM 3750) | 21 |
| 1 3/8" Vinyl Insert Carpet Metal with Pins / Extender (CM 115) | 21 |
| 1 3/8" Vinyl Insert Carpet Metal with Pins (Canadian) (CM 310, CM 310 Flex) | 21 |
| 1 1/4" Vinyl Insert Pinless Carpet Metal (CM 210, CM 210 Flex) | 21 |
| 1 1/4" Vinyl Insert Pinless / Extender (CM 215) | 21 |
| 1 1/4" Vinyl Insert Pinless Trim (Canadian)(CM 410, CM 410 Flex) | 22 |
| 1 1/4" Vinyl Single Flange Track (VT 253 White) | 22 |

► Z-BAR, BINDER BARS & CARPET BAR

| | |
|---|----|
| 1" Standard Binder Bar (CM 313) | 22 |
| 1" Deluxe Binder Bar (CM 303) | 22 |
| 1 1/2" Standard Binder Bar (CM 312) | 23 |
| 1 1/2" Premium Binder Bar (CM 302) | 23 |
| 2" Deluxe Binder Bar (CM 304) | 23 |
| 2 1/2" Deluxe Binder Bar (CM 315, CM 305) | 24 |
| 3/4" Binder Bar - Overlap Edging (CM 701) | 24 |
| Z-Bar | 24 |
| 3/4" Seam Binder (CM 702) | 24 |
| 1" Seam Binder (CM 705) | 25 |
| 1 1/4" Seam Binder (CM 703) | 25 |
| 2 1/2" Seam Binder (CM 704) | 26 |
| 4" Seam Binder (CM 714) | 26 |

► STAIR NOSING

| | |
|--|----|
| 1 1/16" Deluxe Stair Nosing (CM 601) | 26 |
| 1 1/16" Standard Stair Nosing (CM 611) | 26 |
| 1 5/8" Deluxe Stair Nosing (CM 605) | 27 |
| 1 5/8" Standard Wide Tread Stair Nosing (CM 615) | 27 |
| 1 7/8" Deluxe Stair Nosing (CM 627) | 27 |
| 2" Standard Wide Tread Stair Nosing (CM 617) | 28 |
| 2" Deluxe Stair Nosing (CM 607, CM 648) | 28 |
| 2" Deluxe Stair Nosing (CM 637) | 29 |
| 2 1/2" Commercial Stair Nosing (CM 603) | 29 |
| 3 1/4" Commercial Stair Nosing (CM 609) | 30 |
| 3 1/2" Commercial Stair Nosing (CM 619) | 30 |
| 5/32" 4mm LVT Stair Nosing (LVT 606) | 30 |
| 3/16" 5mm LVT Stair Nosing (LVT 608) | 31 |
| 3/16" 5mm LVT Stair Nosing (LVT 610) | 31 |
| 15/64" 6mm LVT Stair Nosing (LVT 604) | 31 |
| 4mm Scribe-To Stair Nosing (CM 602) | 31 |
| 4mm No-Lip Stair Nosing (LVT 343) | 32 |
| 5mm No-Lip Stair Nosing (LVT 341) | 32 |
| 5mm 80 degree No-Lip Stair Nosing (LVT 347) | 32 |
| 4mm No-Lip Stair Riser (LVT 333) | 32 |
| 5mm No-Lip Stair Riser (LVT 331) | 32 |
| 5mm 80 degree No-Lip Stair Riser (LVT 337) | 32 |
| Drive Nails | 33 |
| Straight Edge | 33 |

► COVING, SQUARE & BEVEL CAPS

| | |
|---|----|
| 3/32" Coving Cap (CM 903) | 34 |
| 1/8" Coving Cap (CM 901) | 34 |
| 1/4" Coving Cap (CM 401) | 34 |
| 1/4" Round Coving Cap (CM 400) | 35 |
| 5/32" 4mm Square Cap (CM 904) | 35 |
| 3/16" 5mm Square Cap (CM 905) | 35 |
| 5/16" 5mm Square Cap Ext Lip (CM 915) | 35 |
| 5/32" 4mm Bevel Cap (CM 404) | 35 |
| 3/16" 5mm Bevel Cap (CM 405) | 35 |

► CARPET REDUCERS

| | |
|---|----|
| 1/8" 3mm Carpet Tile to LVT (LVT 130, LVT 130-FLEX) | 36 |
| 3/16" 5mm Carpet to Tile LVT (LVT 150, LVT 150-FLEX) | 36 |
| 3/16" 3mm Carpet Tile to LVT/Bare Floor (LVT 131) | 36 |
| Carpet to 9mm (LVT 190) | 36 |
| 1/8" 3mm Carpet Tile to LVT (LVT 350) | 37 |
| 3/16" 5mm Carpet Tile to LVT/Bare Floor (LVT 160, LVT 160-FLEX) | 37 |
| 13/64" 5mm Carpet Tile Reducer (LVT 115) | 37 |

► SAFETY STAIR NOSING / TREDSAFE® INSERTS

| | |
|--|----|
| Carpet Safety Stair Nosing 1 - 1/2" drop (AA121) | 39 |
| Carpet Safety Stair Nosing 2" drop (AA123) | 39 |
| Carpet Safety Stair Nosing 1 - 3/8" drop (AA345) | 39 |
| Carpet Safety Stair Nosing 1 - 3/8" drop (AA346) | 40 |
| Ceramic Safety Stair Nosing 3/4" drop (AA351) | 40 |
| Bare Floor Safety Stair Nosing 2" drop (AA125) | 41 |
| Safety Joiner for Vinyl (DT025) | 42 |
| Safety Joiner for Carpet (DT026) | 42 |
| Safety Transition for Carpet to Vinyl (DT024) | 43 |
| Safety Transition for Carpet to 3mm LVT (DT027) | 43 |
| Safety Transition for Carpet to Bare Floor (DT028) | 43 |
| Safety Transition for Carpet to 5mm LVT (DT029) | 43 |
| Tredsafe Inserts | 44 |
| Tredsafe Installation Instructions | 46 |

► LVT FLOORING TRIMS & TRANSITIONS

| | |
|---|----|
| 2.5mm to 3.5mm LVT No-Lip Ramp (LVT 123) | 49 |
| 2.5mm to 4.5mm LVT No-Lip Ramp (LVT 124) | 49 |
| 3mm to 4.5mm LVT No-Lip Ramp (LVT 125, LVT 125-FLEX) | 49 |
| 3mm to 5mm LVT No-Lip Ramp (LVT 127) | 49 |
| 2mm to 5mm LVT No-Lip Ramp (LVT 118) | 49 |
| 4.5mm to 7mm LVT No-Lip Ramp (LVT 121) | 50 |
| 2.5mm to 7mm LVT No-Lip Ramp (LVT 129) | 50 |
| 2.5mm to 3mm LVT No-Lip Ramp (LVT 128) | 50 |
| 3mm to 3mm LVT No-Lip Ramp (LVT 133) | 50 |
| 5mm to 5mm LVT No-Lip Ramp (LVT 155) | 50 |
| 14mm to 6mm LVT No-Lip Ramp (LVT 119) | 51 |
| 4.5mm to 15mm LVT No-Lip Ramp (LVT 120) | 51 |
| 7mm to 15mm LVT No-Lip Ramp (LVT 122) | 51 |
| 3mm to 15mm LVT No-Lip Ramp (LVT 126) | 51 |
| 3mm Carpet Tile to LVT (LVT 130, LVT 130-FLEX) | 52 |
| 5mm Carpet to Tile LVT (LVT 150, LVT 150-FLEX) | 52 |
| 3mm Carpet Tile to LVT/Bare Floor (LVT 131) | 52 |
| 5mm Carpet Tile to LVT/Bare Floor (LVT 160, LVT 160-FLEX) | 53 |
| Carpet to 9mm (LVT 190) | 53 |
| 3mm Carpet Tile to LVT (LVT 350) | 53 |
| 2.5mm No-Lip Stair Nosing (LVT 325) | 54 |
| 3mm No-Lip Stair Nosing (LVT 340) | 54 |
| 4mm No-Lip Stair Nosing (LVT 343) | 54 |
| 5mm No-Lip Stair Nosing (LVT 341) | 55 |
| 6mm No-Lip Stair Nosing (LVT 346) | 55 |
| 3mm 80 degree No-Lip Stair Nosing (LVT 342) | 55 |
| 5mm 80 degree No-Lip Stair Nosing (LVT 347) | 55 |
| 3mm No-Lip Stair Riser (LVT 330) | 56 |
| 4mm No-Lip Stair Riser (LVT 333) | 56 |
| 5mm No-Lip Stair Riser (LVT 331) | 56 |
| 6mm No-Lip Stair Riser (LVT 336) | 56 |
| 3mm 80 degree No-Lip Stair Riser (LVT 332) | 57 |
| 5mm 80 degree No-Lip Stair Riser (LVT 337) | 57 |
| 2.5mm LVT Stair Nosing (LVT 625) | 58 |
| 3mm LVT Stair Nosing (LVT 630) | 58 |

| | |
|--|----|
| 4mm LVT Stair Nosing (LVT 606) | 58 |
| 5mm LVT Stair Nosing (LVT 608) | 59 |
| 5mm LVT Stair Nosing Long (LVT 610) | 59 |
| 6mm LVT Stair Nosing (LVT 604) | 59 |
| 7mm LVT Stair Nosing (LVT 612) | 59 |
| 8mm LVT Stair Nosing (LVT 618) | 60 |
| 8mm LVT Stair Nosing (LVT 622) | 60 |
| 2.5mm Bevel Cap (LVT 425) | 60 |
| 3mm Bevel Cap (LVT 406) | 61 |
| 4mm Bevel Cap (LVT 404) | 61 |
| 5mm Bevel Cap (LVT 405) | 61 |
| 7mm Bevel Cap (LVT 407) | 61 |
| 8mm Bevel Cap (LVT 408) | 61 |
| 2.5mm Square Cap (LVT 925) | 62 |
| 3mm Square Cap (LVT 906) | 62 |
| 4mm Square Cap (LVT 904) | 62 |
| 5mm Square Cap (LVT 905) | 62 |
| 5mm Square Cap Ext Lip (LVT 915) | 62 |
| 7mm Square Cap (LVT 907) | 63 |
| 8mm Square Cap (LVT 908) | 63 |
| 10mm Square Cap (LVT 910) | 63 |
| 12mm Square Cap (LVT 912) | 63 |
| 3/8" Existing Ceramic Tile to LVT 3mm+ (ETR 38) | 64 |
| 5/16" Ceramic Tile to LVT 3mm (Edgetek TLVT 516) | 64 |
| 3/8" Ceramic Tile to LVT 3mm (Edgetek TLVT 38) | 64 |
| 2.5mm LVT Joiner (LVT 102) | 65 |
| 3mm LVT Joiner (LVT 103) | 65 |
| 5mm LVT Joiner (LVT 105) | 65 |
| 3mm LVT Reducer (LVT 113) | 66 |
| 5mm LVT Reducer (LVT 115) | 66 |
| 3mm LVT Reducer (LVT 303) | 66 |

► CERAMIC FLOORING TRIMS

| | |
|---|----|
| 1/4" Edgetek L Shape (Edgetek L 14) | 69 |
| 1/4" Tile Trim (TT 14) | 69 |
| 5/16" Edgetek L Shape (Edgetek L 516) | 69 |
| 5/16" Tile Trim (TT 516) | 69 |
| 3/8" Edgetek L Shape (Edgetek L 38) | 69 |
| 3/8" Tile Trim (TT 38) | 70 |
| 1/2" Edgetek L Shape (Edgetek L 12) | 70 |
| 1/2" Tile Trim (TT 12) | 70 |
| 5/8" Tile Trim (TT 58) | 70 |
| 3/8" Ceramic Quarter Round (TQ 38) | 70 |
| 5/16" Edgetek Tile Reducer (Edgetek U 516) | 71 |
| 3/8" Edgetek Tile Reducer (Edgetek U 38) | 71 |
| 1/2" Edgetek Tile Reducer (Edgetek U 12) | 71 |
| 3/8" Existing Ceramic Tile to LVT 3mm+ (ETR 38) | 72 |
| 5/16" Edgetek Tile to LVT (Edgetek TLVT 516) | 72 |
| 3/8" Edgetek Tile to LVT (Edgetek TLVT 38) | 72 |
| 5/16" Edgetek Carpet Tuck (Edgetek CT 516) | 73 |
| 3/8" Edgetek Carpet Tuck (Edgetek CT 38) | 73 |

CONTENTS (Continued)



| | |
|--|----|
| 5/16" Edgetek Tile Bull nose (Edgetek R 516) | 74 |
| 3/8" Edgetek Tile Bull nose (Edgetek R 38) | 74 |
| 5/16 Edgetek Square Corner (Edgetek Q 516) | 74 |
| 3/8" Edgetek Square Corner (Edgetek Q 38) | 74 |
| 5/16" R Corner | 75 |
| 3/8" R Corner | 75 |
| 5/16" Q Corner | 75 |
| 3/8" Q Corner | 75 |
| 5/16" Stair Nosing (Edgetek TS 516) | 76 |
| 3/8" Stair Nosing (Edgetek TS 38) | 76 |
| 3/8" Stair Nosing (Edgetek SE 38) | 76 |
| 3/8" Edgetek Step (Edgetek Step 38) | 77 |
| 9/16" T-Seam Binder (Edgetek T 916) | 77 |

▶ VINYL TRIMS

| | |
|---|----|
| Cove Stick (PVC) for Sheet Vinyl (VT 051, VT 052) | 79 |
| Reducer For Glue-Down Carpet (VT 320) | 79 |
| Carpet Coving Cap (VT 410) | 80 |
| Reducer For Glue-Down Carpet (VT 332, VT 331) | 80 |
| Over The Top Resilient Reducer (VT 326) | 80 |
| Tile Reducer For Resilient Floors (VT 324, VT 325) | 81 |
| Tile and Carpet Joiner (VT 754, VT 756) | 81 |
| Stair Nosing (VT 640, VT 642, VT 641, VT 644) | 82 |
| Snap-In Dividers and Edges (VT 704, VT 703, VT 706) | 83 |

▶ TROWELS

| | |
|-----------------------|----|
| Trowel Specs | 85 |
| Premium Trowels | 86 |
| Economy Trowels | 89 |
| Trowel Selector Guide | 90 |

▶ SPECIALTY MOULDINGS

| | |
|----------------------------------|----|
| 3/4" Tee Moulding (7365) | 93 |
| 1" Tee Moulding (7395) | 93 |
| 1/16" Cap (TM 80) | 94 |
| 1/16" Flat Back Cap (TM 81) | 94 |
| 1/16" Deep Slot Cap (TM 84) | 94 |
| 3/32" Cap (TM 83) | 94 |
| 3/32" Wide Face Cap (TM 82) | 94 |
| 1/8" Cap (WB 104) | 95 |
| 3/16" Cap (TM 72) | 95 |
| 13/32" Cap (7524) | 95 |
| 5/16" Cap (7358) | 95 |
| 5/16" Wide Face Cap (7359) | 95 |
| 1/16" Cap (TM 91) | 96 |
| 1/16" Cove (TM 92) | 96 |
| 1/16" Cove (TM 98, TM 90) | 96 |
| 3/32" Cove (TM 85) | 96 |
| 25/32" Offset Drill Cove (TM 52) | 96 |

| | |
|---|-----|
| 1/16" Divider (TM 94) | 97 |
| 3/32" Divider (WB 110) | 97 |
| 5/32" Divider (WB 103) | 97 |
| 1/4" Division (WB 303) | 97 |
| 1/16" Outside Corner (TM 93) | 98 |
| 1/2" Plain Facing (TM 19) | 98 |
| 3/4" Plain Facing (TM 21) | 98 |
| 7/8" Plain Facing (TM 23) | 98 |
| 1 1/16" Plain Facing (TM 25) | 99 |
| 1 1/4 Plain Facing (TM 24) | 99 |
| 1 1/4" Price Tag Conventional Moulding (0569) | 99 |
| 13/16" Insert Oval Tee (0923) | 99 |
| 13/16" Palisade Insert Tee (7364) | 99 |
| Panel Hanger (7389) | 100 |
| Slat wall Panel (7584) | 100 |
| 1/2" x 1/8" Flat bar (1005) | 101 |
| 3/4" x 1/8" Flat bar (1048) | 101 |
| 1 x 1/8" Flat bar (1004) | 101 |
| 1 1/4 x 1/8" Flat bar (1068) | 101 |
| 1 1/2 x 1/8" Flat bar (1049) | 101 |
| 1/2" Equal Angle (3141) | 102 |
| 3/4" Equal Angle (3151) | 102 |
| 1" Equal Angle (3161) | 102 |
| 3/4" x 3/8" Angle (1750) | 102 |
| 3/4" x 1/2" Angle (1225) | 102 |
| 1" x 1/2" Angle (1033) | 102 |
| 3/4" Equal Angle (1017) | 103 |
| 1" Equal Angle (1018) | 103 |
| 1 1/2" Equal Angle (1022) | 103 |
| 2" Equal Angle (1137) | 103 |
| 2 1/8" x 1" Angle (1249) | 103 |
| 7/16" x 1/4" Channel (1347) | 104 |
| 13/16" x 1/4" Channel (2223) | 104 |
| 1/2" x 5/16" Channel (1038) | 104 |
| 5/16" x 3/8" Channel (1285) | 104 |
| 5/16" x 1/2" Channel (1362) | 104 |
| 9/16" x 1/2" Channel (1346) | 104 |
| 3/4" x 1/2" Channel (1538) | 105 |
| 23/32" x 5/8" Channel (1345) | 105 |
| 5/16" x 3/4" Channel (2161) | 105 |
| 1/2" x 3/4" Channel (1040) | 105 |
| 3/4" x 3/4" Channel (1710) | 105 |
| 1" x 3/4" Channel (1041) | 105 |
| 1" x 3/4" Top Channel (7347) | 105 |

▶ WARRANTY

| | |
|--|-----|
| Warranty, material and maintenance information | 107 |
|--|-----|

ALUMINUM FINISHES

Etched Aluminum
(EA)(BREA)(MFA)



Etched Nickel
(EN)



Etched Bronze
(BRZ)

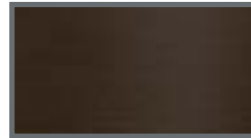

Etched Black
(EBLK)



Mill Finish
(MF)



Etched Brass
Mill Finish Brass
(EB, MFB)



Bright Dip Aluminum
(BBDA)



Bright Dip Brass
(BDB)



Buffed Anodized
(BA)



Hammered Etched Anodized
Hammered Mill Finish
(HEA)(HMF)



Hammered Nickel
(HN)



Hammered Bronze
(HBRZ)

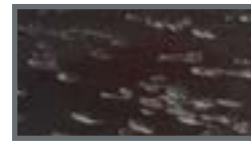

Hammered Black
(HBLK)



Hammered Bright Dip Brass
(HBDB)



Hammered Brass
(HB)



WHITE

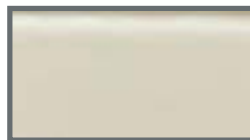

PERGAMON

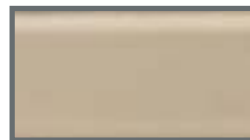

GREY

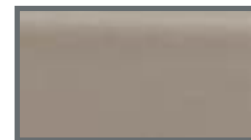

CHERRY

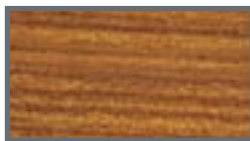

OAK

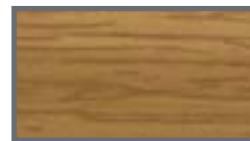

GUNSTOCK

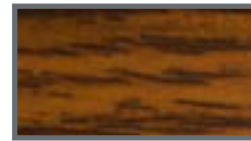

Coventry Gold
(CVG)

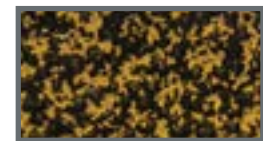

NEW PRODUCTS

Black Finishes

LVT

LVT 130 3mm LVT to Carpet Tile

FINISH: EA, EN, BRZ, EBLK
PAGE: 52

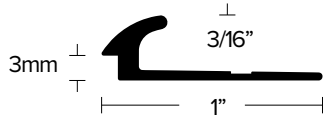

LVT 160 Carpet Tile to LVT/Nothing

FINISH: EA, EN, BRZ, EBLK
PAGE: 53

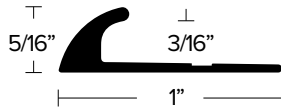

LVT 150 5mm LVT to Carpet Tile

FINISH: EA, EN, BRZ, EBLK
PAGE: 52

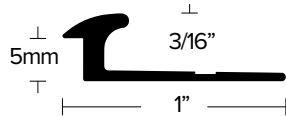

LVT 905 5mm Square Cap

FINISH: EA, EN, BRZ, EBLK
PAGE: 62

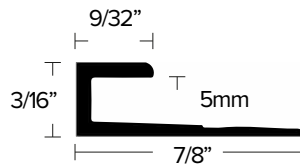

LVT Nosings 2.5mm, 5mm, 12mm

FINISH: EA, EN, BRZ, EBLK (EB in 5mm)
PAGES: 58, 59, 60

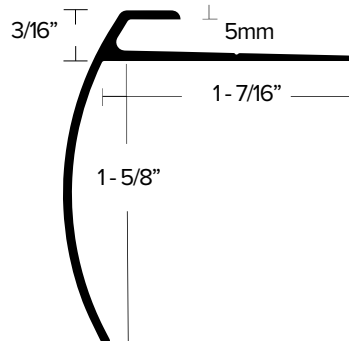

Safety

Carpet Tile Reducers (2mm, 3mm, Bare)

FINISH: EA, EN, BRZ, EBLK
PAGE: 43

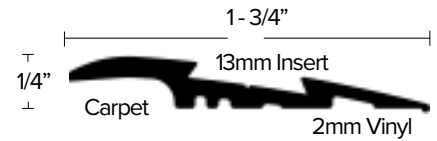

Carpet Tile Joiner 5mm LVT to Carpet Tile

FINISH: EA, EN, BRZ, EBLK
PAGE: 43

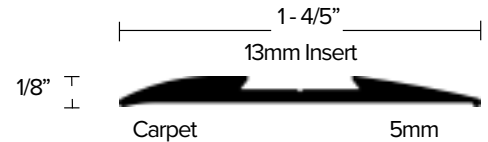

Carpet Tile Joiner Carpet Tile to Carpet Tile

FINISH: EA, EN, BRZ, EBLK
PAGE: 42

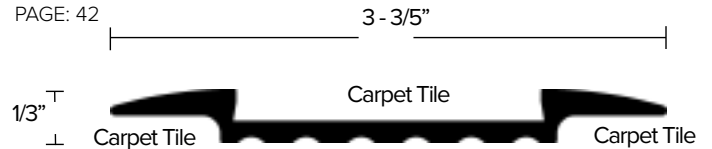

Ceramic

Edgetek™ L Shapes (5/16" and 3/8" Tile)

FINISH: EA, EN, BRZ, EBLK, MF (EB in 3/8")
PAGE: 69

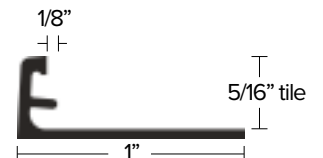

L Shape 1/2" Tile

FINISH: EA, EN, EB, BRZ, EBLK
PAGE: 70

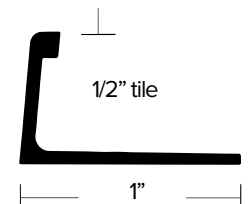

Carpet

CM 100 5/8" Premium Pin Clampdown

FINISH: HMF, HB, HBLK
PAGE: 16

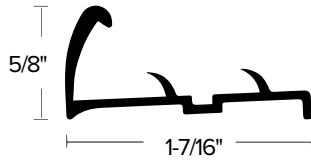

CM 201 1/2" Premium Pinless Clampdown

FINISH: HMF, HB, HEA, HN, HBDB, CVG, HBRZ, HBLK
PAGE: 18



CM 104 1/2" Standard Pin Clampdown

FINISH: HMF, HB, HEA, HN, HBRZ, HBLK
PAGE: 15

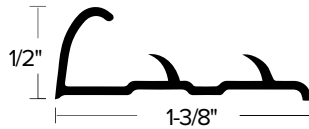

CM 312 1 - 1/2" Standard Binder Bar

FINISH: HMF, HB, HEA, HN, HBDB, HBRZ, HBLK, EBLK, OAK, CHERRY, GUNSTOCK, CVG
PAGE: 23

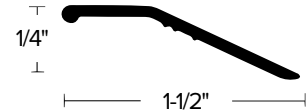

CM 611 1" Standard Stair Nosing

FINISH: HMF, HB, HEA, HN, HBDB, HBRZ, HBLK, CVG
PAGE: 27

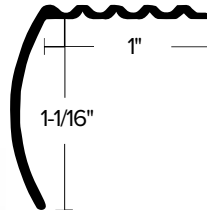

CM 313 1" Standard Binder Bar

FINISH: HMF, HB, HEA, HN, HBDB, HBRZ, HBLK, CVG
PAGE: 22

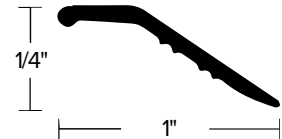

NEW PRODUCTS

SAFETY TRIMS

SAFETY STAIR NOSE

AA351 Ceramic Stair Nose

FINISH: EA
PAGE: 40

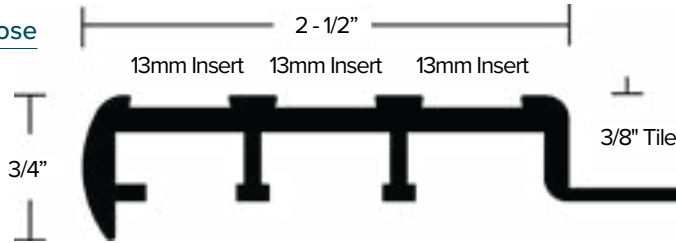

SAFETY TRANSITION

DT024 Carpet to Vinyl

FINISH: EA, EN, BRZ, EBLK
PAGE: 43

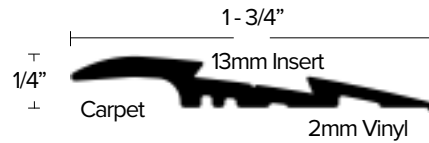

DT027 Carpet to 3mm LVT

FINISH: EA, EN, BRZ, EBLK
PAGE: 43

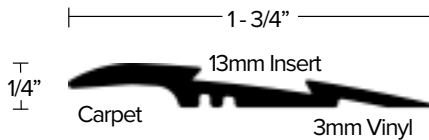

DT028 Carpet to Bare Floor

FINISH: EA, EN, BRZ, EBLK
PAGE: 43

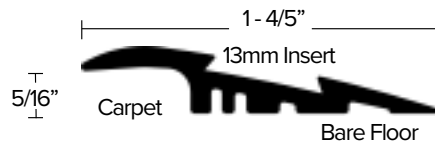

DT029 Carpet to 5mm LVT

FINISH: EA, EN, BRZ, EBLK
PAGE: 43

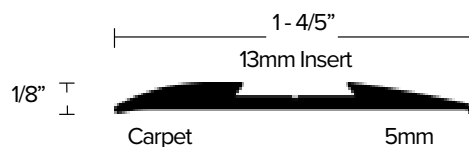

SAFETY TRIMS

SAFETY JOINER

DT026

Joiner

FINISH: EA, EN, BRZ, EBLK
PAGE: 42

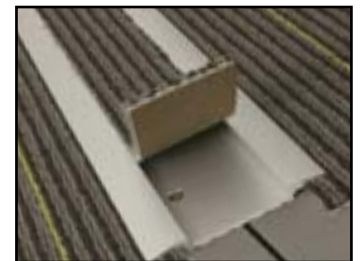
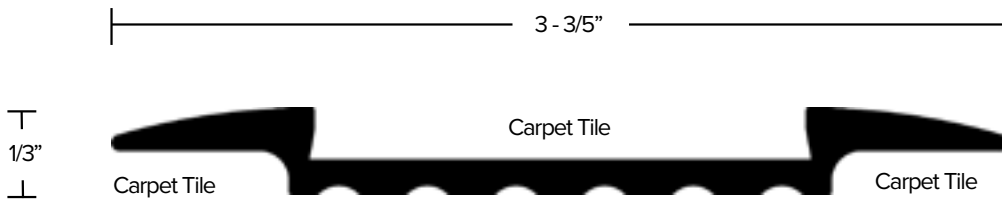

DT025

Joiner

FINISH: EA, EN, BRZ
PAGE: 42

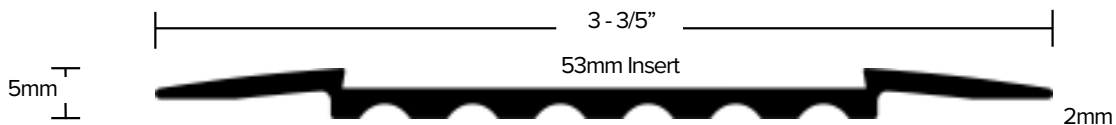

Tredsafe® Inserts

COLOR: Natural Black, Safety Orange, Signal Yellow
SIZE: 13, 43 and 53mm
PAGE: 44

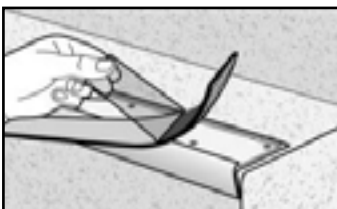

Neutral Black



Signal Yellow



Safety Orange



Mid Grey



Rich Brown



Charcoal

NEW PRODUCTS

LVT TRIMS & TRANSITIONS

LVT REDUCERS

LVT 118 2mm to 5mm No-Lip Ramp

FINISH: MF
PAGE: 49

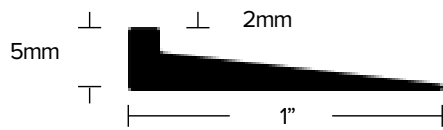

LVT 303 3mm Reducer

FINISH: EA, EN, BRZ, BREA
PAGE: 66



SURFACES OF EQUAL HEIGHT

SEAM BINDER

CM 714 4" Seam Binder

FINISH: EA, EN, BRZ
PAGE: 26

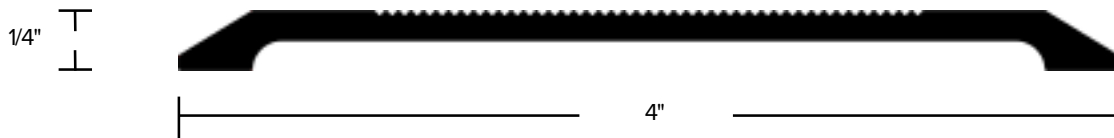

SHEET VINYL

COVE STICK FOR SHEET VINYL

VT 051 1 - 1/4"

PVC
PAGE: 79

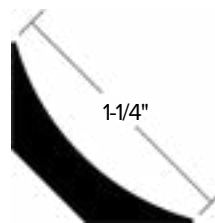

VT 052 1 - 1/2"

PVC
PAGE: 79

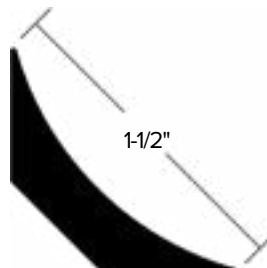

CARPET METAL TRIMS & TRANSITIONS

 Designer trims made to protect and enhance your flooring investment. Made with and without pins or "teeth" for easy installation.



CLAMPDOWN WITH PINS



- Durable clampdown allows protection to carpet edge in areas of high traffic.
- Sharp pins provide strong, long lasting grip on carpets.

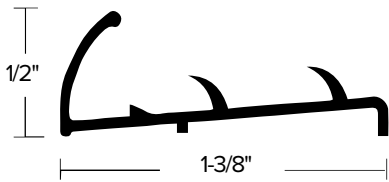

| 1/2" STANDARD PIN CLAMPDOWN | | | | | | |
|-----------------------------|-------------------------|-------------|--------|-----|--------|--|
| ITEM | ITEM DESCRIPTION | NAILS INCL. | LENGTH | QTY | WEIGHT | |
| 031638 | CM 3703 HMF 48lb | NO | 12' | 40 | 52 | |
| 031646 | CM 3703 HB 48lb | NO | 12' | 40 | 52 | |
| 031653 | CM 3703 HEA | NO | 12' | 40 | 52 | |
| 401200 | CM 3703 HN | NO | 12' | 40 | 52 | |
| 031745 | CM 3703 HMF-FLEX | NO | 12' | 12 | 17 | |
| 031752 | CM 3703 HB-FLEX | NO | 12' | 12 | 17 | |
| 406132 | CM 3703 HN-FLEX | NO | 12' | 12 | 17 | |

▶ Punched for nails on 6" centers

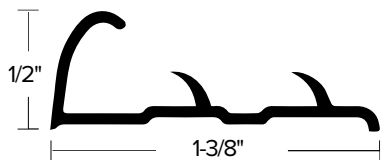

| 1/2" STANDARD PIN CLAMPDOWN | | | | | | |
|-----------------------------|------------------------|-------------|--------|-----|--------|--|
| ITEM | ITEM DESCRIPTION | NAILS INCL. | LENGTH | QTY | WEIGHT | |
| 401127 | CM 104 HMF 48lb | NO | 12' | 40 | 53 | |
| 401128 | CM 104 HB 48lb | NO | 12' | 40 | 53 | |
| 401126 | CM 104 HEA | NO | 12' | 40 | 53 | |
| 401199 | CM 104 HN 48lb | NO | 12' | 40 | 53 | |
| 390162 | CM 104 HBRZ | NO | 12' | 24 | 34 | |
| 402303 | CM 104 HBLK | NO | 12' | 24 | 34 | |

▶ Punched for nails on 6" centers

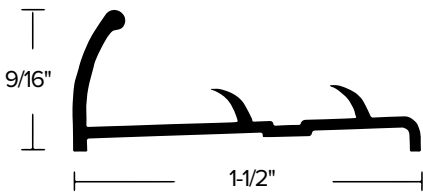

| 9/16" STANDARD PIN CLAMPDOWN | | | | | | |
|------------------------------|-----------------------|-------------|--------|-----|--------|--|
| ITEM | ITEM DESCRIPTION | NAILS INCL. | LENGTH | QTY | WEIGHT | |
| 401060 | CM 95 HMF 48lb | NO | 12' | 40 | 61 | |
| 401061 | CM 95 HB 48lb | NO | 12' | 40 | 61 | |

▶ Punched for nails on 6" centers

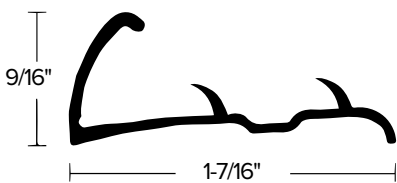

| 9/16" STANDARD PIN CLAMPDOWN | | | | | | |
|------------------------------|-------------------------------------|-------------|--------|-----|--------|--|
| ITEM | ITEM DESCRIPTION | NAILS INCL. | LENGTH | QTY | WEIGHT | |
| 401147 | CM 12-2114 HMF 48lb | NO | 12' | 40 | 61 | |
| 021217 | CM 12-2114 HMF (CARTON) 48lb | NO | 12' | 40 | 61 | |
| 401148 | CM 12-2117 HB 48lb | NO | 12' | 40 | 61 | |
| 401201 | CM 12-2118 HN | NO | 12' | 40 | 61 | |
| 401149 | CM 12-2114 HMF-FLEX | NO | 12' | 12 | 19 | |
| 401155 | CM 12-2117 HB-FLEX | NO | 12' | 12 | 19 | |

▶ Punched for nails on 6" centers

1/2" PREMIUM PIN CLAMPDOWN

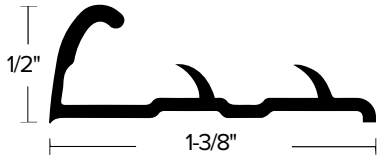

| ITEM | ITEM DESCRIPTION | NAILS INCL. | LENGTH | QTY | WEIGHT |
|--------|---|-------------|--------|-----|--------|
| 401108 | CM 102 HMF 48^{lbs} | NO | 12' | 40 | 66 |
| 401109 | CM 102 HB 48^{lbs} | NO | 12' | 40 | 66 |
| 401202 | CM 102 HN 48^{lbs} | NO | 12' | 40 | 66 |
| 401145 | CM 106 HMF-FLEX 48^{lbs} | NO | 12' | 12 | 21 |
| 401146 | CM 106 HB-FLEX 48^{lbs} | NO | 12' | 12 | 21 |
| 401168 | CM 106 HN-FLEX 48^{lbs} | NO | 12' | 12 | 21 |

▶ Punched for nails on 6" centers

9/16" PREMIUM PIN CLAMPDOWN

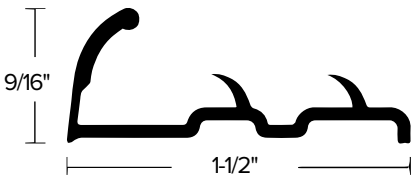

| ITEM | ITEM DESCRIPTION | NAILS INCL. | LENGTH | QTY | WEIGHT |
|--------|------------------------------------|-------------|--------|-----|--------|
| 401105 | CM 101 HMF 48^{lbs} | NO | 12' | 40 | 75 |
| 401106 | CM 101 HB 48^{lbs} | NO | 12' | 40 | 75 |
| 401203 | CM 101 HN 48^{lbs} | NO | 12' | 40 | 75 |
| 401132 | CM 105 HMF-FLEX | NO | 12' | 12 | 24 |
| 401133 | CM 105 HB-FLEX | NO | 12' | 12 | 24 |

▶ Punched for nails on 6" centers

9/16" PREMIUM PIN CLAMPDOWN

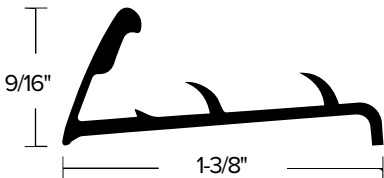

| ITEM | ITEM DESCRIPTION | NAILS INCL. | LENGTH | QTY | WEIGHT |
|--------|-------------------------------------|-------------|--------|-----|--------|
| 031992 | CM 3705 HMF 48^{lbs} | NO | 12' | 40 | 69 |
| 032032 | CM 3705 HB 48^{lbs} | NO | 12' | 40 | 69 |

▶ Punched for nails on 6" centers

5/8" PREMIUM PIN CLAMPDOWN

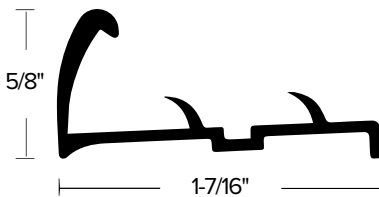

| ITEM | ITEM DESCRIPTION | NAILS INCL. | LENGTH | QTY | WEIGHT |
|--------|------------------------------------|-------------|--------|-----|--------|
| 401083 | CM 100 HMF 48^{lbs} | NO | 12' | 40 | 80 |
| 401084 | CM 100 HB 48^{lbs} | NO | 12' | 40 | 80 |
| 402304 | CM 100 HBLK | NO | 12' | 24 | 46 |
| 401080 | CM 109 HMF-FLEX | NO | 12' | 12 | 27 |
| 401081 | CM 109 HB-FLEX | NO | 12' | 12 | 27 |

▶ Punched for nails on 6" centers

11/16" PREMIUM PIN CLAMPDOWN

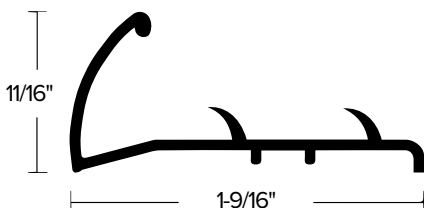

| ITEM | ITEM DESCRIPTION | NAILS INCL. | LENGTH | QTY | WEIGHT |
|--------|--------------------------------------|-------------|--------|-----|--------|
| 031104 | CM 3704 HMF 48^{lbs} | NO | 12' | 40 | 69 |
| 031161 | CM 3704 HB 48^{lbs} | NO | 12' | 40 | 69 |
| 401204 | CM 3704 HN 48^{lbs} | NO | 12' | 40 | 69 |
| 031179 | CM 3704 HBDB 48^{lbs} | NO | 12' | 40 | 69 |

▶ Punched for nails on 6" centers

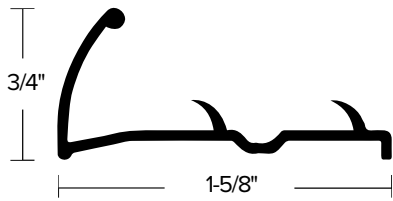

3/4" PREMIUM PIN CLAMPDOWN

| ITEM | ITEM DESCRIPTION | NAILS INCL. | LENGTH | QTY | WEIGHT |
|--------|-----------------------|-------------|--------|-----|--------|
| 401070 | CM 99A HMF 48% | NO | 12' | 40 | 71 |
| 401071 | CM 99A HB 48% | NO | 12' | 40 | 71 |
| 401205 | CM 99A HN | NO | 12' | 40 | 71 |
| 401086 | CM 99A CVG | NO | 12' | 24 | 44 |
| 390166 | CM 99A HBRZ | NO | 12' | 24 | 44 |
| 401052 | CM 107A HMF-FLEX | NO | 12' | 12 | 22 |
| 401053 | CM 107A HB-FLEX | NO | 12' | 12 | 22 |
| 401057 | CM 107A HN-FLEX | NO | 12' | 12 | 22 |
| 401059 | CM 107A HBRZ-FLEX | NO | 12' | 12 | 22 |

► Punched for nails on 6" centers

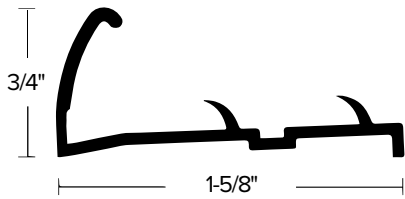

3/4" DELUXE PIN CLAMPDOWN

| ITEM | ITEM DESCRIPTION | NAILS INCL. | LENGTH | QTY | WEIGHT |
|--------|----------------------|-------------|--------|-----|--------|
| 401074 | CM 99 HMF 48% | NO | 12' | 40 | 89 |
| 401075 | CM 99 HB 48% | NO | 12' | 40 | 89 |
| 401093 | CM 99 HBDB | NO | 12' | 12 | 29 |
| 401077 | CM 107 HMF-FLEX | NO | 12' | 12 | 27 |
| 401078 | CM 107 HB-FLEX | NO | 12' | 12 | 27 |
| 401094 | CM 107 HBDB-FLEX | NO | 12' | 12 | 27 |

► Punched for nails on 6" centers

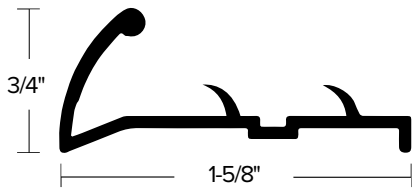

3/4" DELUXE PIN CLAMPDOWN

| ITEM | ITEM DESCRIPTION | NAILS INCL. | LENGTH | QTY | WEIGHT |
|--------|-----------------------|-------------|--------|-----|--------|
| 409920 | CM 654 HMF 48% | NO | 12' | 40 | 89 |
| 409925 | CM 654 HMF | NO | 12' | 24 | 55 |
| 409921 | CM 654 HB 48% | NO | 12' | 40 | 89 |
| 409926 | CM 654 HB | NO | 12' | 24 | 55 |
| 401206 | CM 654 HN 48% | NO | 12' | 40 | 89 |
| 409927 | CM 654 HBDB | NO | 12' | 24 | 55 |
| 401098 | CM 654 HMF-FLEX | NO | 12' | 12 | 26 |

► Punched for nails on 6" centers

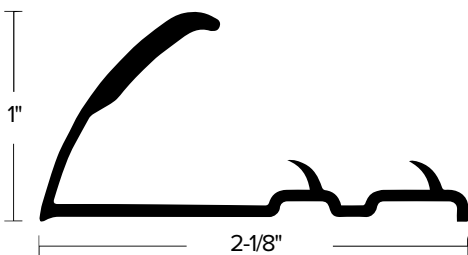

1" COMMERCIAL PIN CLAMPDOWN

| ITEM | ITEM DESCRIPTION | NAILS INCL. | LENGTH | QTY | WEIGHT |
|--------|------------------|-------------|--------|-----|--------|
| 401118 | CM 103 HMF | NO | 12' | 12 | 44 |
| 401119 | CM 103 HB | NO | 12' | 12 | 44 |

► Punched for nails on 6" centers



PINLESS CLAMPDOWNS

- Pinless material made for glue down carpets

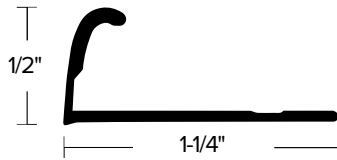

1/2" PREMIUM PINLESS CLAMPDOWN

| ITEM | ITEM DESCRIPTION | NAILS INCL. | LENGTH | QTY | WEIGHT |
|--------|------------------------|-------------|--------|-----|--------|
| 402106 | CM 201 HMF <i>48hr</i> | NO | 12' | 40 | 52 |
| 402108 | CM 201 HB <i>48hr</i> | NO | 12' | 40 | 52 |
| 402109 | CM 201 HEA | NO | 12' | 40 | 52 |
| 401207 | CM 201 HN <i>48hr</i> | NO | 12' | 40 | 52 |
| 402116 | CM 201 HBDB | NO | 12' | 24 | 33 |
| 402302 | CM 201 HBLK | NO | 12' | 24 | 33 |
| 402105 | CM 201 CVG | NO | 12' | 24 | 33 |
| 390167 | CM 201 HBRZ | NO | 12' | 24 | 33 |
| 401325 | CM 205 HMF-FLEX | NO | 12' | 12 | 16 |
| 401326 | CM 205 HB -FLEX | NO | 12' | 12 | 16 |
| 402122 | CM 205 HN-FLEX | NO | 12' | 12 | 16 |

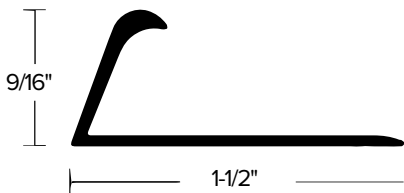

9/16" DELUXE PINLESS CLAMPDOWN

| ITEM | ITEM DESCRIPTION | NAILS INCL. | LENGTH | QTY | WEIGHT |
|--------|------------------|-------------|--------|-----|--------|
| 402150 | CM 211 HMF | NO | 12' | 40 | 61 |
| 402153 | CM 211 HMF | NO | 12' | 12 | 20 |
| 401352 | CM 211 HB | NO | 12' | 12 | 20 |
| 402149 | CM 211 HMF-FLEX | NO | 12' | 12 | 18 |

► No fabrication, nail starter lines

BLANK CLAMPDOWN FOR TACK STRIP

- Blank bar allows for a tack strip to be glued down on top of metal.
- Durable clampdown allows protection to carpet edge in areas of high traffic.

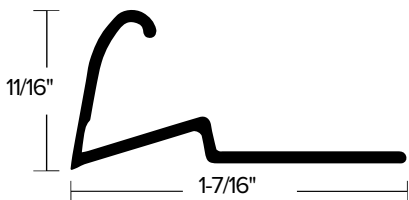

| 11/16" CLAMPDOWN FOR TACK STRIPS | | | | | | |
|----------------------------------|-----------------------------------|-------------|--------|-----|--------|--|
| ITEM | ITEM DESCRIPTION | NAILS INCL. | LENGTH | QTY | WEIGHT | |
| 401252 | CM 121 HMF 48ⁱⁿ | NO | 12' | 40 | 69 | |
| 401253 | CM 121 HB 48ⁱⁿ | NO | 12' | 40 | 69 | |
| 401208 | CM 121 HN | NO | 12' | 40 | 69 | |

JOINER BARS

- Joiner bar divides glued or stretched-in carpets to ceramic, laminate, or hardwood floors.

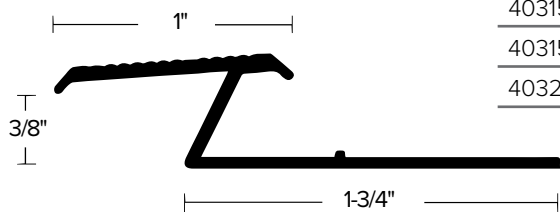

| 1" CARPET TILE JOINER | | | | | | |
|-----------------------|------------------|-------------|--------|-----|--------|--|
| ITEM | ITEM DESCRIPTION | NAILS INCL. | LENGTH | QTY | WEIGHT | |
| 403157 | CM 308 MFA | NO | 12' | 12 | 35 | |
| 403158 | CM 308 MFB | NO | 12' | 12 | 35 | |
| 403228 | CM 308 EN | NO | 12' | 12 | 35 | |

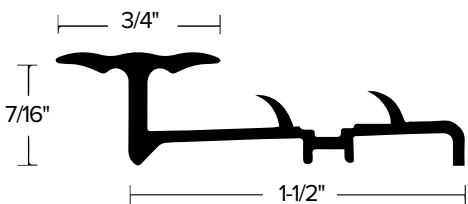

| 3/4" PALISADE JOINER WITH PINS | | | | | | |
|--------------------------------|------------------|-------------|--------|-----|--------|--|
| ITEM | ITEM DESCRIPTION | NAILS INCL. | LENGTH | QTY | WEIGHT | |
| 401150 | CM 108 HMF | NO | 12' | 12 | 33 | |
| 401151 | CM 108 HB | NO | 12' | 12 | 33 | |
| 401154 | CM 108 HEA | NO | 12' | 12 | 33 | |
| 401169 | CM 108 HN | NO | 12' | 12 | 33 | |

► Punched for nails on 6" centers

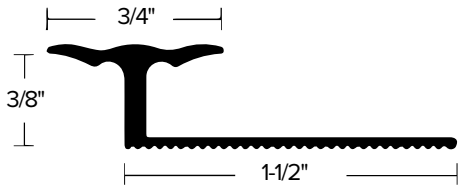

3/4" PALISADE PINLESS JOINER

| ITEM | ITEM DESCRIPTION | NAILS INCL. | LENGTH | QTY | WEIGHT |
|--------|------------------|-------------|--------|-----|--------|
| 402135 | CM 208 HMF | NO | 12' | 12 | 26 |
| 401170 | CM 208 HN | NO | 12' | 12 | 26 |

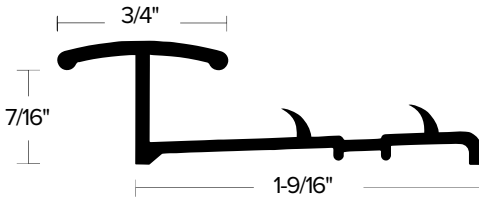

3/4" JOINER WITH PINS

| ITEM | ITEM DESCRIPTION | NAILS INCL. | LENGTH | QTY | WEIGHT |
|--------|------------------|-------------|--------|-----|--------|
| 406134 | CM 112 HEA | NO | 12' | 12 | 32 |
| 401186 | CM 112 HN | NO | 12' | 12 | 32 |

► Punched for nails on 6" centers

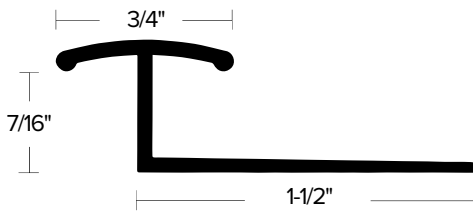

3/4" PINLESS JOINER

| ITEM | ITEM DESCRIPTION | NAILS INCL. | LENGTH | QTY | WEIGHT |
|--------|------------------|-------------|--------|-----|--------|
| 406133 | CM 212 HEA | NO | 12' | 12 | 28 |
| 401189 | CM 212 HN | NO | 12' | 12 | 28 |



INSERT METAL WITH PINS

- Allows for transition between action backed carpet and other flooring types.
- For use with vinyl insert.

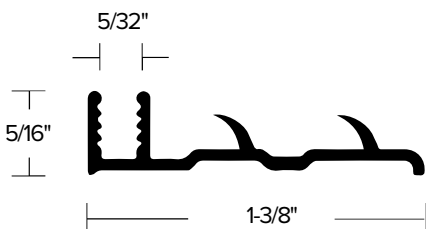

5/16" VINYL INSERT CARPET METAL WITH PINS

| ITEM | ITEM DESCRIPTION | NAILS INCL. | LENGTH | QTY | WEIGHT |
|--------|---------------------------|-------------|--------|-----|--------|
| 401159 | CM 110 MF 48¢ | NO | 12' | 40 | 54 |
| 401165 | CM 110 MF 48¢ | NO | 12' | 20 | 29 |
| 401160 | CM 110 MF-FLEX 48¢ | NO | 12' | 12 | 16 |

► Punched for nails on 6" centers

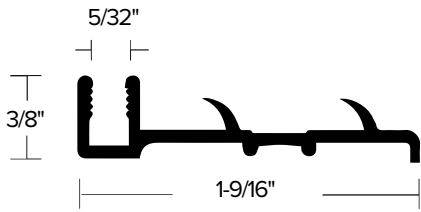

| 3/8" VINYL INSERT CARPET METAL WITH PINS | | | | | |
|--|------------------|-------------|--------|-----|--------|
| ITEM | ITEM DESCRIPTION | NAILS INCL. | LENGTH | QTY | WEIGHT |
| 032552 | CM 3750 MF | NO | 12' | 20 | 34 |

▶ Punched for nails on 6" centers

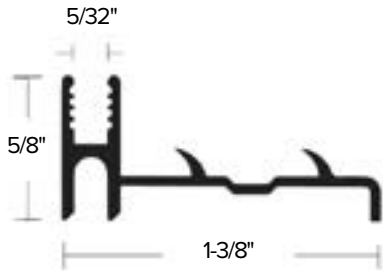

| 5/8" VINYL INSERT CARPET METAL WITH PINS/EXTENDER | | | | | |
|---|------------------|-------------|--------|-----|--------|
| ITEM | ITEM DESCRIPTION | NAILS INCL. | LENGTH | QTY | WEIGHT |
| 415159 | CM 115 MF | NO | 12' | 12 | 25 |

▶ Punched for nails on 6" centers

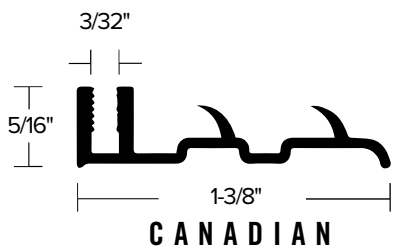

| 5/16" VINYL INSERT CARPET METAL WITH PINS | | | | | |
|---|-----------------------------------|-------------|--------|-----|--------|
| ITEM | ITEM DESCRIPTION | NAILS INCL. | LENGTH | QTY | WEIGHT |
| 402160 | CM 310 MF 48^{hrs} | NO | 12' | 40 | 65 |
| 402159 | CM 310 MF-FLEX * | NO | 12' | 12 | 19 |

▶ Canadian Vinyl Insert metal. Punched for Nails, 6" centers

INSERT METAL PINLESS

- Allows for transition between non action backed carpet and other flooring types.
- For use with vinyl insert.

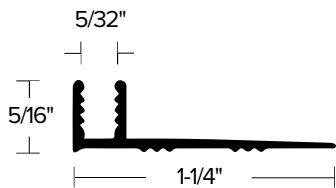
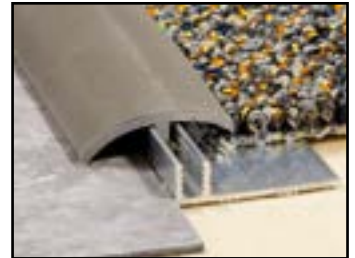

| 5/16" VINYL INSERT PINLESS CARPET METAL | | | | | |
|---|------------------|-------------|--------|-----|--------|
| ITEM | ITEM DESCRIPTION | NAILS INCL. | LENGTH | QTY | WEIGHT |
| 401158 | CM 210 MF | NO | 12' | 40 | 49 |
| 401166 | CM 210 MF | NO | 12' | 20 | 26 |
| 401157 | CM 210 MF-FLEX | NO | 12' | 12 | 15 |

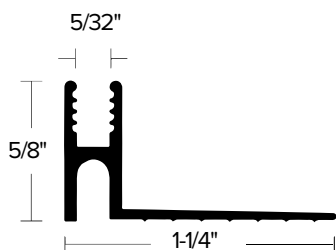

| 5/8" VINYL INSERT PINLESS / EXTENDER | | | | | |
|--------------------------------------|------------------|-------------|--------|-----|--------|
| ITEM | ITEM DESCRIPTION | NAILS INCL. | LENGTH | QTY | WEIGHT |
| 415160 | CM 215 MF | NO | 12' | 12 | 23 |

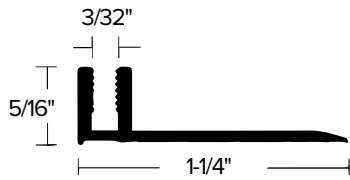

5/16" VINYL INSERT PINLESS CARPET METAL

| ITEM | ITEM DESCRIPTION | NAILS INCL. | LENGTH | QTY | WEIGHT |
|--------|-----------------------------------|-------------|--------|-----|--------|
| 402161 | CM 410 MF 48^{lbs} | NO | 12' | 40 | 59 |
| 402163 | CM 410 MF-FLEX | NO | 12' | 12 | 17 |

▶ Canadian Vinyl Insert metal

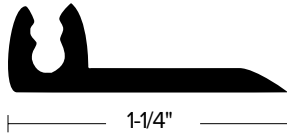

VINYL SINGLE FLANGE TRACK

| ITEM | ITEM DESCRIPTION | LENGTH | QTY | WEIGHT |
|--------|------------------|--------|-----|--------|
| 460530 | VT 253 WHITE | 12' | 20 | 20 |



FLAT BAR

- Flat bar transitions between two surfaces of different height.

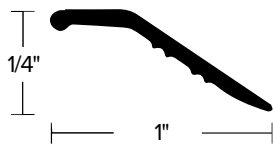

1" STANDARD BINDER BAR

| ITEM | ITEM DESCRIPTION | NAILS INCL. | LENGTH | QTY | WEIGHT |
|--------|------------------------------------|-------------|--------|-----|--------|
| 403170 | CM 313 HMF 48^{lbs} | NO | 12' | 40 | 34 |
| 403181 | CM 313 HMF 48^{lbs} | YES | 12' | 40 | 37 |
| 403219 | CM 313 HMF 48^{lbs} | YES | 12' | 12 | 14 |
| 403171 | CM 313 HB 48^{lbs} | NO | 12' | 40 | 34 |
| 403180 | CM 313 HB 48^{lbs} | YES | 12' | 40 | 37 |
| 403211 | CM 313 HB 48^{lbs} | YES | 12' | 12 | 14 |
| 403169 | CM 313 HEA | NO | 12' | 40 | 34 |
| 404107 | CM 313 HN | YES | 12' | 12 | 14 |
| 401209 | CM 313 HN 48^{lbs} | YES | 12' | 40 | 37 |
| 390437 | CM 313 CVG | YES | 12' | 24 | 24 |
| 390165 | CM 313 HBRZ | YES | 12' | 24 | 24 |
| 402306 | CM 313 HBLK | YES | 12' | 24 | 24 |

▶ Drilled and countersunk, 6" centers for #3 fastener

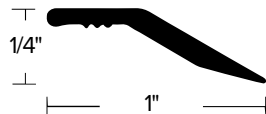

1" DELUXE BINDER BAR

| ITEM | ITEM DESCRIPTION | NAILS INCL. | LENGTH | QTY | WEIGHT |
|--------|------------------------------------|-------------|--------|-----|--------|
| 403121 | CM 303 HMF 48^{lbs} | NO | 12' | 40 | 45 |
| 403122 | CM 303 HB 48^{lbs} | NO | 12' | 40 | 45 |
| 401210 | CM 303 HN 48^{lbs} | YES | 12' | 40 | 48 |

▶ Drilled and countersunk, 6" centers for #3 fastener

1 - 1/2" STANDARD BINDER BAR

| ITEM | ITEM DESCRIPTION | NAILS INCL. | LENGTH | QTY | WEIGHT |
|--------|-------------------------|-------------|--------|-----|--------|
| 403160 | CM 312 HMF <i>48lb</i> | NO | 12' | 40 | 56 |
| 390432 | CM 312 HMF <i>48lb</i> | YES | 12' | 40 | 58 |
| 390456 | CM 312 HMF | YES | 12' | 24 | 36 |
| 403161 | CM 312 HB <i>48lb</i> | NO | 12' | 40 | 56 |
| 390431 | CM 312 HB <i>48lb</i> | YES | 12' | 40 | 58 |
| 390455 | CM 312 HB | YES | 12' | 24 | 36 |
| 403159 | CM 312 HEA | NO | 12' | 40 | 56 |
| 401211 | CM 312 HN <i>48lb</i> | YES | 12' | 40 | 58 |
| 390435 | CM 312 HBDB <i>48lb</i> | YES | 12' | 40 | 58 |
| 402129 | CM 312 HBDB | YES | 12' | 24 | 36 |
| 390436 | CM 312 CVG <i>48lb</i> | YES | 12' | 24 | 36 |
| 390163 | CM 312 HBRZ | YES | 12' | 24 | 36 |
| 402305 | CM312 HBLK | YES | 12' | 24 | 36 |
| 403257 | CM 312 OAK | YES | 12' | 24 | 36 |
| 403258 | CM 312 CHERRY | YES | 12' | 24 | 36 |
| 403259 | CM 312 GUNSTOCK | YES | 12' | 24 | 36 |
| 402254 | CM 312 EBLK | YES | 12' | 24 | 36 |

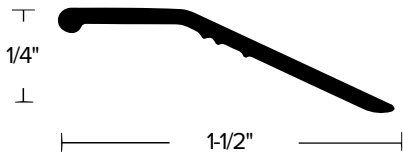

► Drilled and countersunk, 6" centers for #3 fastener

1 - 1/2" PREMIUM BINDER BAR

| ITEM | ITEM DESCRIPTION | NAILS INCL. | LENGTH | QTY | WEIGHT |
|--------|------------------------|-------------|--------|-----|--------|
| 403111 | CM 302 HMF <i>48lb</i> | NO | 12' | 40 | 59 |
| 403117 | CM 302 HMF | YES | 12' | 40 | 61 |
| 403112 | CM 302 HB <i>48lb</i> | NO | 12' | 40 | 59 |
| 401212 | CM 302 HN <i>48lb</i> | YES | 12' | 40 | 61 |
| 403118 | CM 302 HBDB | YES | 12' | 40 | 61 |

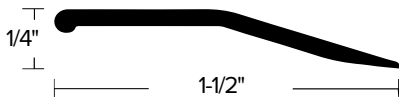

► Drilled and countersunk, 6" centers for #3 fastener

2" DELUXE BINDER BAR

| ITEM | ITEM DESCRIPTION | NAILS INCL. | LENGTH | QTY | WEIGHT |
|--------|------------------------|-------------|--------|-----|--------|
| 403140 | CM 304 HMF <i>48lb</i> | NO | 12' | 12 | 35 |
| 403182 | CM 304 HMF <i>48lb</i> | YES | 12' | 12 | 35 |
| 403141 | CM 304 HB <i>48lb</i> | NO | 12' | 12 | 35 |
| 403183 | CM 304 HB <i>48lb</i> | YES | 12' | 12 | 35 |
| 401102 | CM 304 HEA | NO | 12' | 12 | 35 |
| 403231 | CM 304 HN | YES | 12' | 12 | 35 |
| 403142 | CM 304 HBDB | YES | 12' | 12 | 35 |

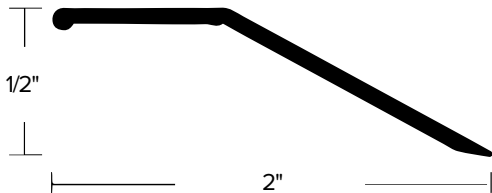

► Drilled and countersunk, 6" centers for #3 fastener

2 - 1/2" DELUXE BINDER BAR

| ITEM | ITEM DESCRIPTION | NAILS INCL. | LENGTH | QTY | WEIGHT |
|--------|------------------|-------------|--------|-----|--------|
| 403305 | CM 315 HMF | YES | 12' | 12 | 54 |
| 403306 | CM 315 HB | NO | 12' | 12 | 54 |

▶ Drilled and countersunk, 6" centers for #3 fastener

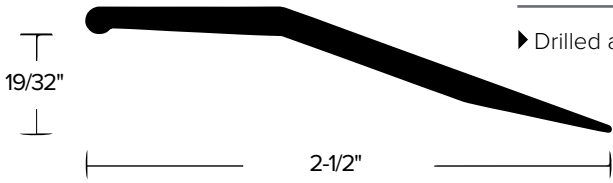

2 - 1/2" DELUXE BINDER BAR

| ITEM | ITEM DESCRIPTION | NAILS INCL. | LENGTH | QTY | WEIGHT |
|--------|------------------|-------------|--------|-----|--------|
| 390321 | CM 305 HMF | NO | 12' | 12 | 62 |
| 390322 | CM 305 HB | NO | 12' | 12 | 62 |

▶ Drilled and countersunk, 6" centers for #8 fastener

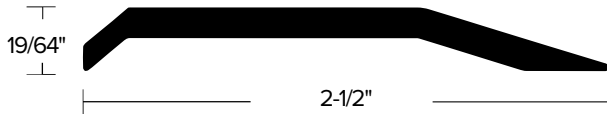

3/4" BINDER BAR-OVERLAPPING

| ITEM | ITEM DESCRIPTION | NAILS INCL. | LENGTH | QTY | WEIGHT |
|--------|------------------|-------------|--------|-----|--------|
| 407101 | CM 701 HMF | NO | 12' | 40 | 34 |
| 403205 | CM 701 HMF | YES | 12' | 40 | 37 |
| 403216 | CM 701 HMF | YES | 12' | 12 | 14 |

▶ Drilled and countersunk, 6" centers for #3 fastener

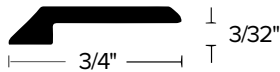

Z BAR

- Creates a finished edge for stretch-in carpet to hard flooring transitions.

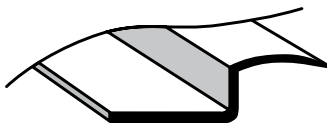

Z-BAR

| ITEM | ITEM DESCRIPTION | NAILS INCL. | LENGTH | QTY | WEIGHT |
|--------|------------------|-------------|--------|-----|--------|
| 404150 | CM 501 MF | NO | 4.0 | 25 | 5 |

SEAM BINDER

- Seam binder transitions between two surfaces with large gap or equal height.

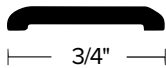

3/4" SEAM BINDER

| ITEM | ITEM DESCRIPTION | NAILS INCL. | LENGTH | QTY | WEIGHT |
|--------|------------------|-------------|--------|-----|--------|
| 407115 | CM 702 HMF | NO | 12' | 40 | 39 |
| 403201 | CM 702 HMF | YES | 12' | 40 | 42 |
| 407120 | CM 702 HB | NO | 12' | 40 | 39 |
| 407121 | CM 702 HEA | NO | 12' | 40 | 39 |
| 401215 | CM 702 HN | YES | 12' | 40 | 42 |

▶ Drilled and countersunk, 6" centers for #3 fastener

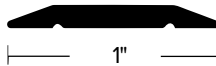

1" SEAM BINDER

| ITEM | ITEM DESCRIPTION | NAILS INCL. | LENGTH | QTY | WEIGHT |
|--------|------------------|-------------|--------|-----|--------|
| 401193 | CM 705 HEA | NO | 12' | 40 | 52 |
| 401192 | CM 705 HB | NO | 12' | 40 | 52 |
| 401216 | CM 705 HN | NO | 12' | 40 | 52 |

▶ Drilled and countersunk, 6" centers for #3 fastener

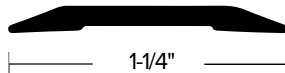

1 - 1/4" SEAM BINDER

| ITEM | ITEM DESCRIPTION | NAILS INCL. | LENGTH | QTY | WEIGHT |
|--------|------------------|-------------|--------|-----|--------|
| 407135 | CM 703 HMF | NO | 12' | 40 | 57 |
| 403203 | CM 703 HMF | YES | 12' | 40 | 59 |
| 407140 | CM 703 HB | NO | 12' | 40 | 57 |
| 403204 | CM 703 HB | YES | 12' | 40 | 59 |
| 401103 | CM 703 HEA | NO | 12' | 40 | 57 |
| 401217 | CM 703 HN | YES | 12' | 40 | 59 |

▶ Drilled and countersunk, 6" centers for #3 fastener

2 - 1/2" SEAM BINDER

| ITEM | ITEM DESCRIPTION | NAILS INCL. | LENGTH | QTY | WEIGHT |
|--------|------------------|-------------|--------|-----|--------|
| 031018 | CM 704 HMF | YES | 12' | 12 | 63 |
| 570048 | CM 704 MFA | NO | 12' | 12 | 63 |
| 031042 | CM 704 HB | YES | 12' | 12 | 63 |

▶ Drilled and countersunk, 6" centers for #8 fastener

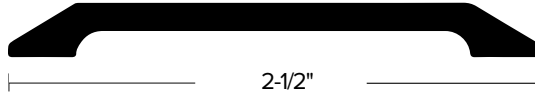

4" SEAM BINDER

| ITEM | ITEM DESCRIPTION | NAILS INCL. | LENGTH | QTY | WEIGHT |
|--------|------------------|-------------|--------|-----|--------|
| 402275 | CM 714 EA | NO | 12' | 12 | 90 |
| 402276 | CM 714 EN | NO | 12' | 12 | 90 |
| 402277 | CM 714 BRZ | NO | 12' | 12 | 90 |

▶ Drilled and countersunk, 6" centers for #3 fastener

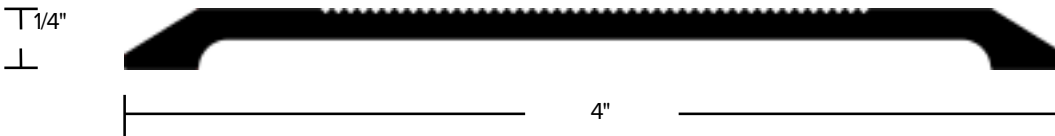

STAIR NOSING

- The durable stair nosing protects the edge of the stair from damage.
- Multiple drops and landing sizes available.

1 - 1/16" DELUXE STAIR NOSING

| ITEM | ITEM DESCRIPTION | NAILS INCL. | LENGTH | QTY | WEIGHT |
|--------|------------------------|-------------|--------|-----|--------|
| 406102 | CM 601 HMF 48lb | NO | 12' | 40 | 81 |
| 406130 | CM 601 HMF 48lb | YES | 12' | 40 | 83 |
| 406103 | CM 601 HB 48lb | NO | 12' | 40 | 81 |
| 406131 | CM 601 HB 48lb | YES | 12' | 40 | 83 |
| 401214 | CM 601 HN 48lb | YES | 12' | 40 | 83 |
| 389135 | CM 601 CVG | YES | 12' | 12 | 27 |
| 401122 | CM 601 OAK | YES | 12' | 24 | 51 |
| 401124 | CM 601 GUNSTOCK | YES | 12' | 24 | 51 |

▶ Drilled and countersunk, 6" centers for #3 fastener

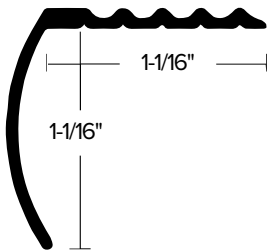

1" STANDARD STAIR NOSING

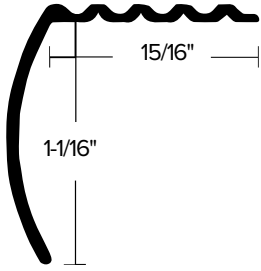

| ITEM | ITEM DESCRIPTION | NAILS INCL. | LENGTH | QTY | WEIGHT |
|--------|------------------------------------|-------------|--------|-----|--------|
| 406115 | CM 611 HMF 48^{lbs} | NO | 12' | 40 | 68 |
| 403207 | CM 611 HMF 48^{lbs} | YES | 12' | 40 | 70 |
| 403267 | CM 611 HMF | YES | 12' | 24 | 43 |
| 403218 | CM 611 HMF 48^{lbs} | YES | 12' | 12 | 23 |
| 406116 | CM 611 HB 48^{lbs} | NO | 12' | 40 | 68 |
| 403187 | CM 611 HB 48^{lbs} | YES | 12' | 40 | 70 |
| 402124 | CM 611 HB | YES | 12' | 24 | 43 |
| 403214 | CM 611 HB 48^{lbs} | YES | 12' | 12 | 23 |
| 403230 | CM 611 HEA | YES | 12' | 40 | 70 |
| 401213 | CM 611 HN 48^{lbs} | YES | 12' | 40 | 70 |
| 403215 | CM 611 HBDB | YES | 12' | 12 | 23 |
| 390438 | CM 611 CVG 48^{lbs} | YES | 12' | 24 | 43 |
| 390164 | CM 611 HBRZ | YES | 12' | 24 | 43 |
| 402307 | CM 611 HBLK | YES | 12' | 24 | 43 |

▶ Drilled and countersunk, 6" centers for #3 fastener

1 - 5/8" DELUXE STAIR NOSING

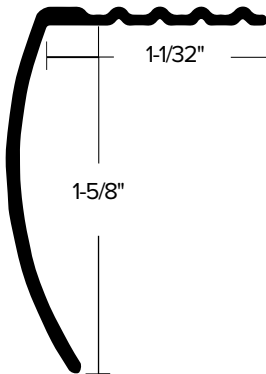

| ITEM | ITEM DESCRIPTION | NAILS INCL. | LENGTH | QTY | WEIGHT |
|--------|------------------------------------|-------------|--------|-----|--------|
| 406160 | CM 605 HMF 48^{lbs} | NO | 12' | 12 | 30 |
| 403191 | CM 605 HMF 48^{lbs} | YES | 12' | 12 | 30 |
| 406161 | CM 605 HB 48^{lbs} | NO | 12' | 12 | 30 |
| 403192 | CM 605 HB 48^{lbs} | YES | 12' | 12 | 30 |
| 406165 | CM 605 HEA | NO | 12' | 12 | 30 |
| 406159 | CM 605 HN 48^{lbs} | YES | 12' | 12 | 30 |
| 403240 | CM 605 CVG | YES | 12' | 12 | 30 |
| 403145 | CM 605 HBRZ | YES | 12' | 12 | 30 |

▶ Drilled and countersunk, 6" centers for #3 fastener

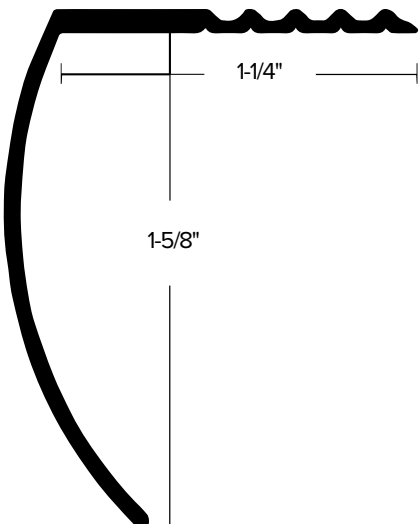

1 - 5/8" STANDARD WIDE TREAD STAIR NOSING

| ITEM | ITEM DESCRIPTION | NAILS INCL. | LENGTH | QTY | WEIGHT |
|--------|------------------------------------|-------------|--------|-----|--------|
| 406166 | CM 615 HMF 48^{lbs} | YES | 12' | 12 | 35 |
| 406167 | CM 615 HB 48^{lbs} | YES | 12' | 12 | 35 |
| 403232 | CM 615 HN | YES | 12' | 12 | 35 |

▶ Drilled and countersunk, 6" centers for #10 fastener

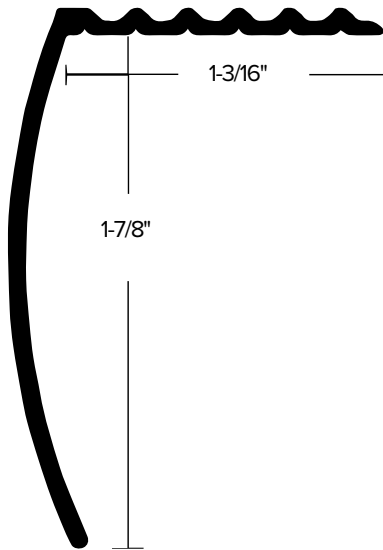

1 - 7/8" DELUXE STAIR NOSING

| ITEM | ITEM DESCRIPTION | NAILS INCL. | LENGTH | QTY | WEIGHT |
|--------|------------------|-------------|--------|-----|--------|
| 406182 | CM 627 HMF | NO | 12' | 12 | 38 |
| 406184 | CM 627 HB | NO | 12' | 12 | 38 |
| 406183 | CM 627 HN | NO | 12' | 12 | 38 |

▶ Drilled and countersunk, 6" centers for #3 fastener

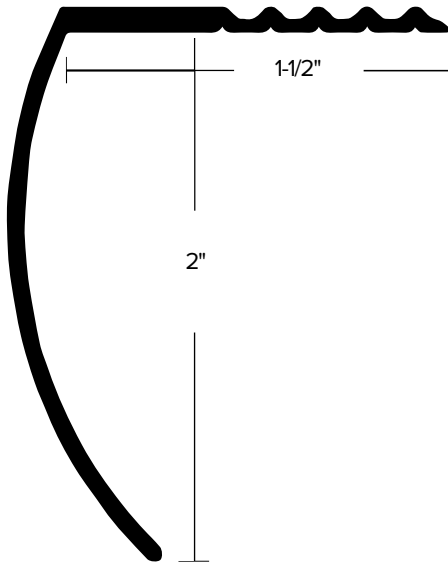

2" STANDARD WIDE TREAD STAIR NOSING

| ITEM | ITEM DESCRIPTION | NAILS INCL. | LENGTH | QTY | WEIGHT |
|--------|------------------|-------------|--------|-----|--------|
| 406174 | CM 617 HMF | NO | 12' | 12 | 47 |
| 406175 | CM 617 HB | NO | 12' | 12 | 47 |

▶ Drilled and countersunk, 6" centers for #3 fastener

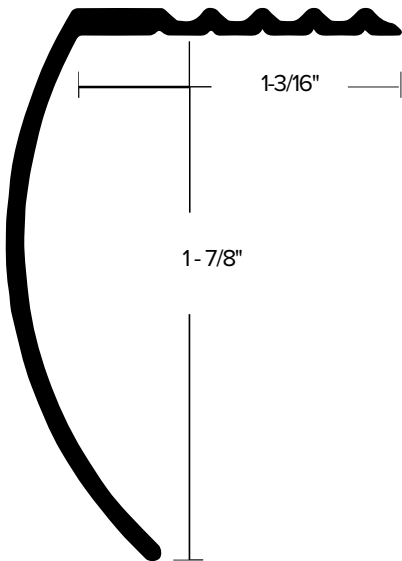

2" DELUXE STAIR NOSING

| ITEM | ITEM DESCRIPTION | NAILS INCL. | LENGTH | QTY | WEIGHT |
|--------|------------------|-------------|--------|-----|--------|
| 406170 | CM 607 HMF | NO | 12' | 12 | 41 |
| 406171 | CM 607 HB | NO | 12' | 12 | 41 |
| 406176 | CM 607 HN | YES | 12' | 12 | 42 |

▶ Drilled and countersunk, 6" centers for #3 fastener

*Illustrations do not represent actual size.

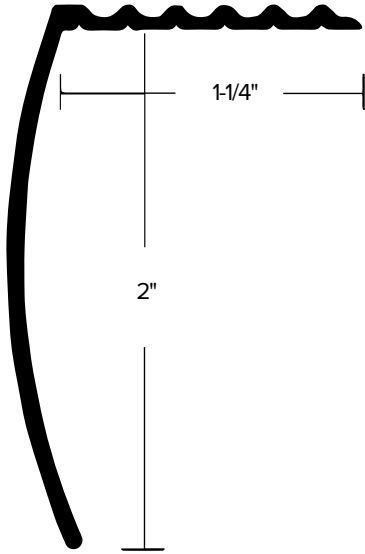

2" DELUXE STAIR NOSING

| ITEM | ITEM DESCRIPTION | NAILS INCL. | LENGTH | QTY | WEIGHT |
|--------|------------------|-------------|--------|-----|--------|
| 406124 | CM 648 HMF | YES | 12' | 12 | 37 |
| 406126 | CM 648 HB | YES | 12' | 12 | 37 |
| 406127 | CM 648 HN | YES | 12' | 12 | 37 |
| 406125 | CM 648 HBDB | YES | 12' | 12 | 37 |

► Drilled and countersunk, 6" centers for #3 fastener

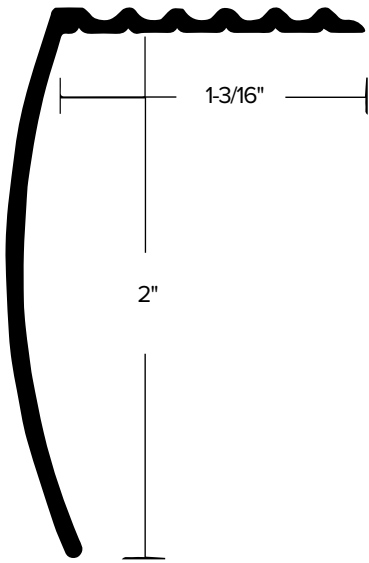

2" DELUXE STAIR NOSING

| ITEM | ITEM DESCRIPTION | NAILS INCL. | LENGTH | QTY | WEIGHT |
|--------|------------------|-------------|--------|-----|--------|
| 406185 | CM 637 HMF | NO | 12' | 12 | 39 |
| 406186 | CM 637 HB | NO | 12' | 12 | 39 |
| 406189 | CM 637 HEA | NO | 12' | 12 | 39 |
| 406187 | CM 637 HN | NO | 12' | 12 | 39 |

► Drilled and countersunk, 6" centers for #3 fastener

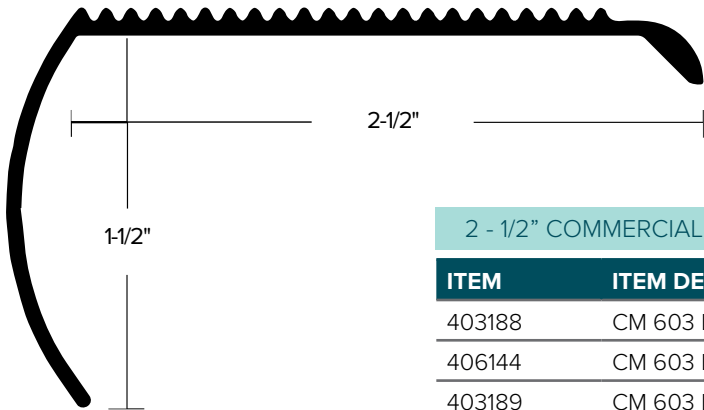

2 - 1/2" COMMERCIAL STAIR NOSING

| ITEM | ITEM DESCRIPTION | NAILS INCL. | LENGTH | QTY | WEIGHT |
|--------|------------------|-------------|--------|-----|--------|
| 403188 | CM 603 EA | YES | 12' | 12 | 39 |
| 406144 | CM 603 BA | YES | 12' | 12 | 39 |
| 403189 | CM 603 EB | YES | 12' | 12 | 39 |
| 403266 | CM 603 EN | YES | 12' | 12 | 39 |

► Drilled and countersunk, 6" centers for #3 fastener

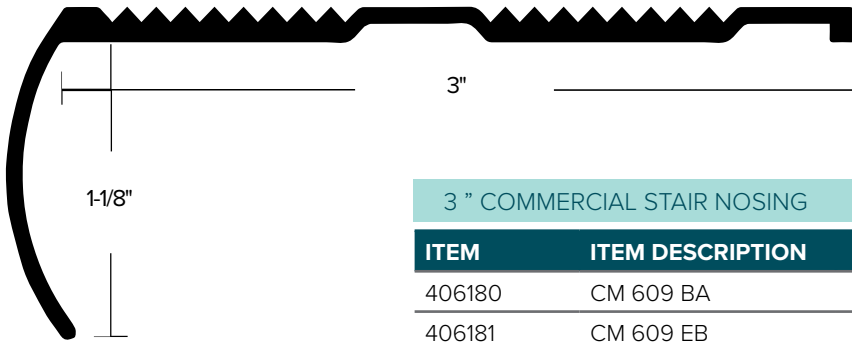

3 " COMMERCIAL STAIR NOSING

| ITEM | ITEM DESCRIPTION | NAILS INCL. | LENGTH | QTY | WEIGHT |
|--------|------------------|-------------|--------|-----|--------|
| 406180 | CM 609 BA | NO | 12' | 12 | 62 |
| 406181 | CM 609 EB | NO | 12' | 12 | 62 |

► Drilled and countersunk for #4 screw, 6" centers

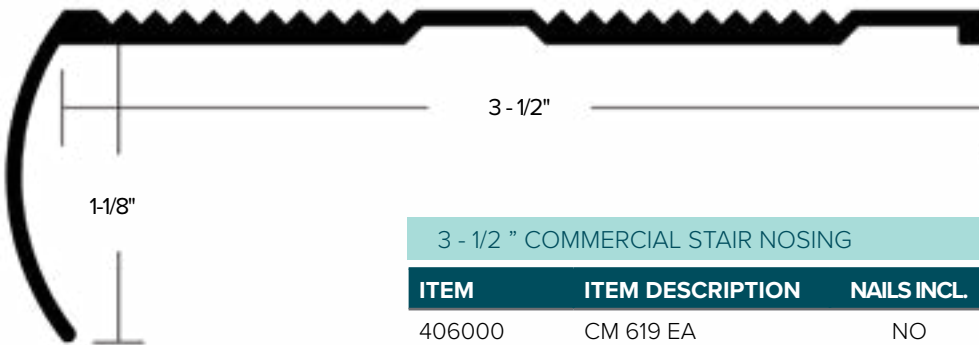

3 - 1/2 " COMMERCIAL STAIR NOSING

| ITEM | ITEM DESCRIPTION | NAILS INCL. | LENGTH | QTY | WEIGHT |
|--------|------------------|-------------|--------|-----|--------|
| 406000 | CM 619 EA | NO | 12' | 12 | 68 |

► Drilled and countersunk for #4 screw, 6" centers

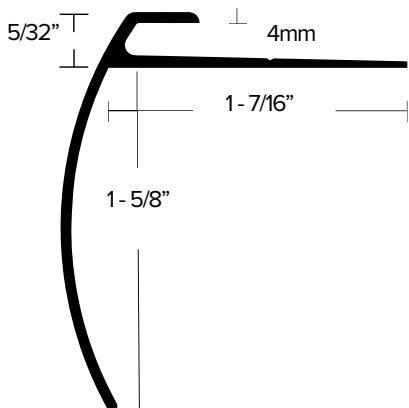

3/32" (4MM) CARPET TILE STAIR NOSING

| ITEM | ITEM DESCRIPTION | NAILS INCL. | LENGTH | QTY | WEIGHT |
|--------|------------------|-------------|--------|-----|--------|
| 401176 | LVT 606 EA | NO | 12' | 12 | 37 |
| 401177 | LVT 606 EN | NO | 12' | 12 | 37 |
| 401175 | LVT 606 BRZ | NO | 12' | 12 | 37 |

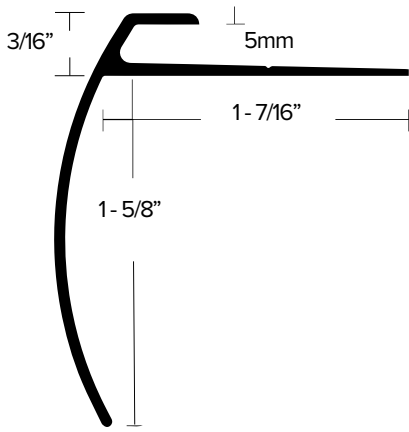

| 3/16" 5MM CARPET TILE STAIR NOSING | | | | | |
|------------------------------------|------------------|-------------|--------|-----|--------|
| ITEM | ITEM DESCRIPTION | NAILS INCL. | LENGTH | QTY | WEIGHT |
| 389141 | LVT 608 EA | NO | 12' | 12 | 37 |
| 389143 | LVT 608 EN | NO | 12' | 12 | 37 |
| 390168 | LVT 608 BRZ | NO | 12' | 12 | 37 |
| 402273 | LVT 608 EBLK | NO | 12' | 12 | 37 |
| 389142 | LVT 608 EB | NO | 12' | 12 | 37 |

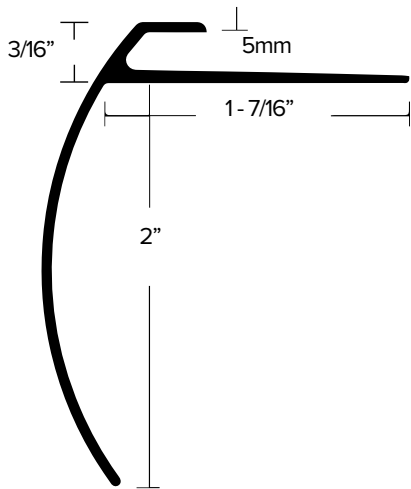

| 3/16" 5MM CARPET TILE STAIR NOSING (LONG) | | | | | |
|---|------------------|-------------|--------|-----|--------|
| ITEM | ITEM DESCRIPTION | NAILS INCL. | LENGTH | QTY | WEIGHT |
| 401178 | LVT 610 EA | NO | 12' | 12 | 41 |
| 401179 | LVT 610 EN | NO | 12' | 12 | 41 |
| 401180 | LVT 610 BRZ | NO | 12' | 12 | 41 |

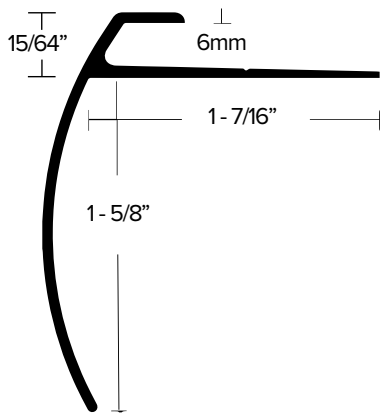

| 1/4" (6MM) CARPET TILE STAIR NOSING | | | | | |
|-------------------------------------|------------------|-------------|--------|-----|--------|
| ITEM | ITEM DESCRIPTION | NAILS INCL. | LENGTH | QTY | WEIGHT |
| 401197 | LVT 604 EA | NO | 12' | 12 | 37 |
| 401198 | LVT 604 EN | NO | 12' | 12 | 37 |
| 401196 | LVT 604 BRZ | NO | 12' | 12 | 37 |

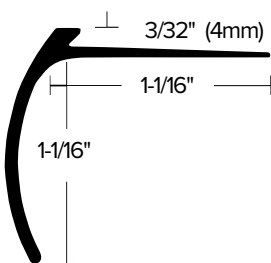

| 3/32" (4MM) "SCRIBE-TO" STAIR NOSING | | | | | |
|--------------------------------------|------------------|-------------|--------|-----|--------|
| ITEM | ITEM DESCRIPTION | NAILS INCL. | LENGTH | QTY | WEIGHT |
| 406121 | CM 602 HMF | NO | 12' | 40 | 81 |

► Drilled and countersunk, 6" centers for #3 fastener

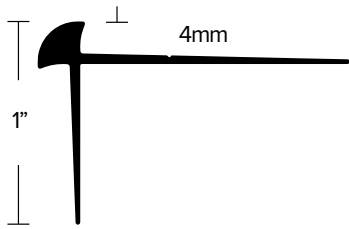

3/32" (4MM) NO-LIP STAIR NOSING

| ITEM | ITEM DESCRIPTION | NAILS INCL. | LENGTH | QTY | WEIGHT |
|--------|------------------|-------------|--------|-----|--------|
| 402083 | LVT 343 EA | NO | 12' | 12 | 26 |
| 402084 | LVT 343 EN | NO | 12' | 12 | 26 |
| 402085 | LVT 343 BRZ | NO | 12' | 12 | 26 |

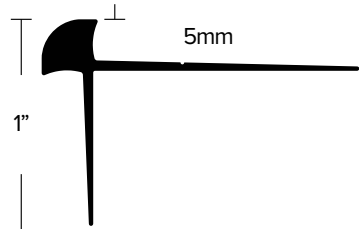

3/16" (5MM) NO-LIP STAIR NOSING

| ITEM | ITEM DESCRIPTION | NAILS INCL. | LENGTH | QTY | WEIGHT |
|--------|------------------|-------------|--------|-----|--------|
| 402046 | LVT 341 EA | NO | 12' | 12 | 28 |
| 402047 | LVT 341 EN | NO | 12' | 12 | 28 |
| 402048 | LVT 341 BRZ | NO | 12' | 12 | 28 |

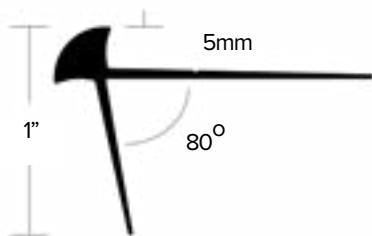

5MM NO-LIP STAIR NOSING 80° ANGLE

| ITEM | ITEM DESCRIPTION | NAILS INCL. | LENGTH | QTY | WEIGHT |
|--------|------------------|-------------|--------|-----|--------|
| 402220 | LVT 347 EA | NO | 12' | 12 | 24 |
| 402221 | LVT 347 EN | NO | 12' | 12 | 24 |
| 402222 | LVT 347 BRZ | NO | 12' | 12 | 24 |

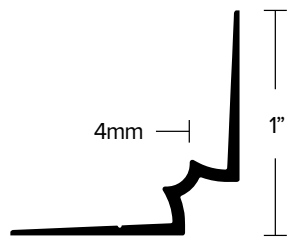

3/32" (4MM) NO-LIP STAIR RISER

| ITEM | ITEM DESCRIPTION | NAILS INCL. | LENGTH | QTY | WEIGHT |
|--------|------------------|-------------|--------|-----|--------|
| 508735 | LVT 333 EA | NO | 12' | 12 | 19 |
| 508736 | LVT 333 EN | NO | 12' | 12 | 19 |
| 508737 | LVT 333 BRZ | NO | 12' | 12 | 19 |

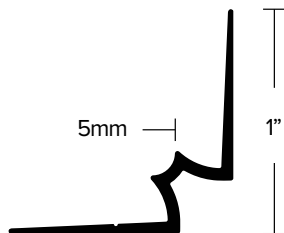

3/16" (5MM) NO-LIP STAIR RISER

| ITEM | ITEM DESCRIPTION | NAILS INCL. | LENGTH | QTY | WEIGHT |
|--------|------------------|-------------|--------|-----|--------|
| 402014 | LVT 331 EA | NO | 12' | 12 | 19 |
| 402049 | LVT 331 EN | NO | 12' | 12 | 19 |
| 402050 | LVT 331 BRZ | NO | 12' | 12 | 19 |

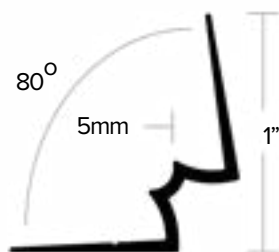

5MM NO-LIP STAIR RISER 80° ANGLE

| ITEM | ITEM DESCRIPTION | NAILS INCL. | LENGTH | QTY | WEIGHT |
|--------|------------------|-------------|--------|-----|--------|
| 402225 | LVT 337 EA | NO | 12' | 12 | 19 |
| 402224 | LVT 337 EN | NO | 12' | 12 | 19 |
| 402223 | LVT 337 BRZ | NO | 12' | 12 | 19 |

DRIVE NAILS

- Drive nails are used to fasten flooring trims to wood floor.
- Some products come with nails included.



COUNTERSUNK OVAL HEAD SCREW NAILS



| ITEM | ITEM DESCRIPTION | FINISH | PACK | QTY PER PACK |
|--------|------------------|----------|-------------|--------------|
| 482066 | DRIVE NAIL | CHERRY | 24 pack | 25 |
| 482068 | DRIVE NAIL | GUNSTOCK | 24 pack | 25 |
| 482041 | DRIVE NAIL | BRASS | 40 pack | 25 |
| 482059 | DRIVE NAIL | BLACK | 24 pack | 25 |
| 482036 | DRIVE NAIL | BRASS | 50 lbs bulk | - |
| 489008 | DRIVE NAIL | BRONZE | 24 pack | 25 |
| 482070 | DRIVE NAIL | NICKEL | 12 pack | 25 |
| 482074 | DRIVE NAIL | NICKEL | 40 pack | 25 |
| 482072 | DRIVE NAIL | OAK | 24 pack | 25 |
| 482026 | DRIVE NAIL | SILVER | 50 lbs bulk | - |
| 482031 | DRIVE NAIL | SILVER | 40 pack | 25 |
| 482063 | DRIVE NAIL | NICKEL | 50 lbs bulk | - |
| 482071 | DRIVE NAIL | BLACK | 12 pack | 25 |

STRAIGHT EDGE

- Straight edge is a useful tool for installers that acts as a guide to cut carpet to have a straight edge.

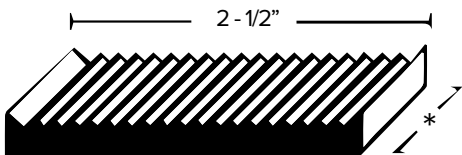

* 36", 75" 2 - 1/2"

2 - 1/2" STRAIGHT EDGE

| ITEM | ITEM DESCRIPTION | NAILS INCL. | LENGTH | QTY | WEIGHT |
|--------|----------------------------------|-------------|--------|-----|--------|
| 409170 | CM 36 EA 48^{lbs} | NO | 36" | 6 | 21 |
| 409171 | CM 75 EA 48^{lbs} | NO | 75" | 6 | 40 |

▶ 45° angle, one end only



CAPS

- Coving carpet up walls and cap off for a smooth look.

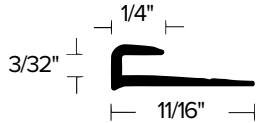

3/32" COVING CAP

| ITEM | ITEM DESCRIPTION | NAILS INCL. | LENGTH | QTY | WEIGHT |
|--------|------------------------------------|-------------|--------|-----|--------|
| 409155 | CM 903 MFA 48^{lbs} | NO | 12' | 40 | 26 |
| 409165 | CM 903 EB | NO | 12' | 40 | 26 |
| 410817 | CM 903 EN | NO | 12' | 24 | 17 |
| 409154 | CM 903 MFA | NO | 12' | 12 | 10 |

▶ Punched and slotted on 2" centers

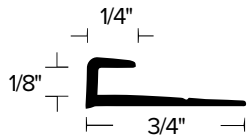

1/8" COVING CAP

| ITEM | ITEM DESCRIPTION | NAILS INCL. | LENGTH | QTY | WEIGHT |
|--------|------------------------------------|-------------|--------|-----|--------|
| 409110 | CM 901 HMF | NO | 8' | 60 | 31 |
| 409115 | CM 901 HMF 48^{lbs} | NO | 12' | 40 | 32 |
| 409130 | CM 901 MFA 48^{lbs} | NO | 8' | 60 | 31 |
| 409105 | CM 901 MFA 48^{lbs} | NO | 12' | 40 | 32 |
| 409135 | CM 901 MFB 48^{lbs} | NO | 8' | 60 | 31 |
| 530706 | CM 901 HN | NO | 12' | 24 | 21 |
| 409986 | CM 901 EN | NO | 12' | 40 | 32 |

▶ Punched and slotted on 2" centers

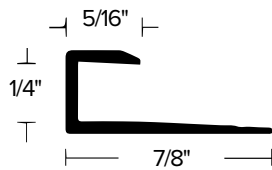

1/4" COVING CAP

| ITEM | ITEM DESCRIPTION | NAILS INCL. | LENGTH | QTY | WEIGHT |
|--------|------------------------------------|-------------|--------|-----|--------|
| 409956 | CM 401 HMF | NO | 12' | 40 | 36 |
| 409980 | CM 401 MFA 48^{lbs} | NO | 12' | 40 | 36 |
| 404101 | CM 401 BA | NO | 12' | 40 | 36 |
| 409955 | CM 401 HB | NO | 12' | 40 | 36 |
| 409981 | CM 401 MFB | NO | 12' | 40 | 36 |
| 409985 | CM 401 EN | NO | 12' | 40 | 36 |

▶ Punched and slotted on 2" centers

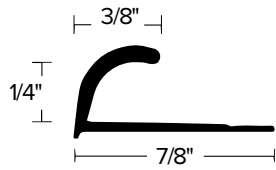

1/4" ROUND COVING CAP

| ITEM | ITEM DESCRIPTION | NAILS INCL. | LENGTH | QTY | WEIGHT |
|--------|------------------|-------------|--------|-----|--------|
| 404049 | CM 400 HMF | NO | 12' | 40 | 39 |

► No fabrication. Nail starter lines

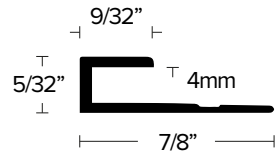

5/32" (4MM) SQUARE CAP

| ITEM | ITEM DESCRIPTION | NAILS INCL. | LENGTH | QTY | WEIGHT |
|--------|------------------|-------------|--------|-----|--------|
| 403263 | LVT 904 EA | NO | 12' | 24 | 22 |
| 403264 | LVT 904 EN | NO | 12' | 24 | 22 |
| 403265 | LVT 904 BRZ | NO | 12' | 24 | 22 |

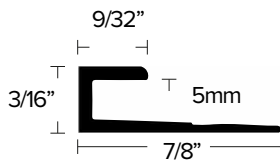

3/16" (5MM) SQUARE CAP

| ITEM | ITEM DESCRIPTION | NAILS INCL. | LENGTH | QTY | WEIGHT |
|--------|------------------|-------------|--------|-----|--------|
| 403262 | LVT 905 EA | NO | 12' | 24 | 22 |
| 403261 | LVT 905 EN | NO | 12' | 24 | 22 |
| 403260 | LVT 905 BRZ | NO | 12' | 24 | 22 |
| 402267 | LVT 905 EBLK | NO | 12' | 24 | 22 |

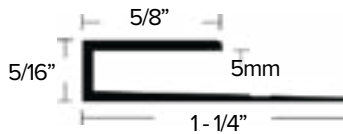

5MM SQUARE CAP EXTENDED LIP

| ITEM | ITEM DESCRIPTION | NAILS INCL. | LENGTH | QTY | WEIGHT |
|--------|------------------|-------------|--------|-----|--------|
| 402157 | LVT 915 EA | NO | 12' | 24 | 33 |
| 402156 | LVT 915 EN | NO | 12' | 24 | 33 |
| 402155 | LVT 915 BRZ | NO | 12' | 24 | 33 |

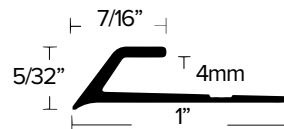

5/32" (4MM) BEVEL CAP

| ITEM | ITEM DESCRIPTION | NAILS INCL. | LENGTH | QTY | WEIGHT |
|--------|------------------|-------------|--------|-----|--------|
| 390153 | LVT 404 EA | NO | 12' | 24 | 27 |
| 390154 | LVT 404 EN | NO | 12' | 24 | 27 |
| 390155 | LVT 404 BRZ | NO | 12' | 24 | 27 |

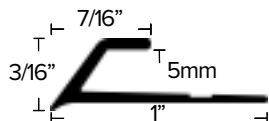

3/16" (5MM) BEVEL CAP

| ITEM | ITEM DESCRIPTION | NAILS INCL. | LENGTH | QTY | WEIGHT |
|--------|------------------|-------------|--------|-----|--------|
| 390159 | LVT 405 EA | NO | 12' | 24 | 28 |
| 390160 | LVT 405 EN | NO | 12' | 24 | 28 |
| 390161 | LVT 405 BRZ | NO | 12' | 24 | 28 |



CARPET TO LVT

- Transitions from carpet tile to LVT of 3 or 5 mm height.
- Transitions from stretch carpet to 9mm flooring

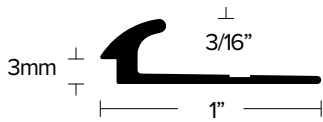

3MM LVT TO CARPET TILE

| ITEM | ITEM DESCRIPTION | NAILS INCL. | LENGTH | QTY | WEIGHT |
|--------|------------------|-------------|--------|-----|--------|
| 402000 | LVT 130 EA | NO | 12' | 24 | 31 |
| 402001 | LVT 130 EN | NO | 12' | 24 | 31 |
| 402002 | LVT 130 BRZ | NO | 12' | 24 | 31 |
| 402269 | LVT 130 EBLK | NO | 12' | 24 | 31 |
| 510118 | LVT 130 EA-FLEX | NO | 12' | 12 | 17 |
| 510119 | LVT 130 EN-FLEX | NO | 12' | 12 | 17 |
| 510120 | LVT 130 BRZ-FLEX | NO | 12' | 12 | 17 |

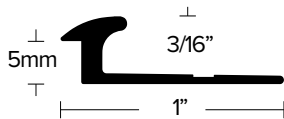

5MM LVT TO CARPET TILE

| ITEM | ITEM DESCRIPTION | NAILS INCL. | LENGTH | QTY | WEIGHT |
|--------|------------------|-------------|--------|-----|--------|
| 402003 | LVT 150 EA | NO | 12' | 24 | 32 |
| 402004 | LVT 150 EN | NO | 12' | 24 | 32 |
| 402005 | LVT 150 BRZ | NO | 12' | 24 | 32 |
| 402270 | LVT 150 EBLK | NO | 12' | 24 | 32 |
| 510121 | LVT 150 EA-FLEX | NO | 12' | 12 | 18 |
| 510122 | LVT 150 EN-FLEX | NO | 12' | 12 | 18 |
| 510123 | LVT 150 BRZ-FLEX | NO | 12' | 12 | 18 |



3MM LVT TO CARPET TILE

| ITEM | ITEM DESCRIPTION | NAILS INCL. | LENGTH | QTY | WEIGHT |
|--------|------------------|-------------|--------|-----|--------|
| 402101 | LVT 131 EA | NO | 12' | 24 | 36 |
| 402102 | LVT 131 EN | NO | 12' | 24 | 36 |
| 402103 | LVT 131 BRZ | NO | 12' | 24 | 36 |

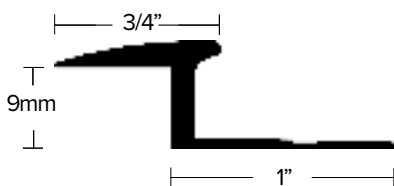

STRETCH CARPET TO 9MM

| ITEM | ITEM DESCRIPTION | NAILS INCL. | LENGTH | QTY | WEIGHT |
|--------|------------------|-------------|--------|-----|--------|
| 402096 | LVT 190 EA | NO | 12' | 12 | 25 |
| 402097 | LVT 190 EN | NO | 12' | 12 | 25 |
| 402098 | LVT 190 BRZ | NO | 12' | 12 | 25 |

3MM LVT TO CARPET TILE

| ITEM | ITEM DESCRIPTION | NAILS INCL. | LENGTH | QTY | WEIGHT |
|--------|------------------|-------------|--------|-----|--------|
| 402010 | LVT 350 BREA | NO | 12' | 40 | 143 |

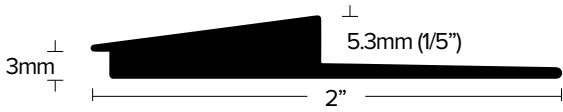

CARPET TILE REDUCERS

- Transition from carpet tile to nothing.



CARPET TILE TO LVT/NOTHING

| ITEM | ITEM DESCRIPTION | NAILS INCL. | LENGTH | QTY | WEIGHT |
|--------|------------------|-------------|--------|-----|--------|
| 402006 | LVT 160 EA | NO | 12' | 24 | 34 |
| 402007 | LVT 160 EN | NO | 12' | 24 | 34 |
| 402008 | LVT 160 BRZ | NO | 12' | 24 | 34 |
| 402271 | LVT 160 EBLK | NO | 12' | 24 | 34 |
| 510124 | LVT 160 EA-FLEX | NO | 12' | 12 | 19 |
| 510125 | LVT 160 EN-FLEX | NO | 12' | 12 | 19 |
| 510126 | LVT 160 BRZ-FLEX | NO | 12' | 12 | 19 |

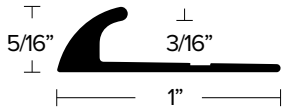

13/64" (5MM) CARPET TILE REDUCER

| ITEM | ITEM DESCRIPTION | NAILS INCL. | LENGTH | QTY | WEIGHT |
|--------|------------------|-------------|--------|-----|--------|
| 402065 | LVT 115 EA | NO | 12' | 24 | 67 |
| 402066 | LVT 115 EN | NO | 12' | 24 | 67 |
| 402067 | LVT 115 BRZ | NO | 12' | 24 | 67 |

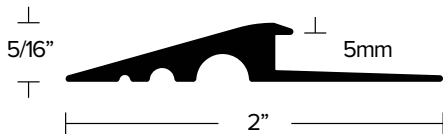

SAFETY STAIR NOSING FEATURING TREDSAFE® INSERTS



THE EDGE
ON SAFETY

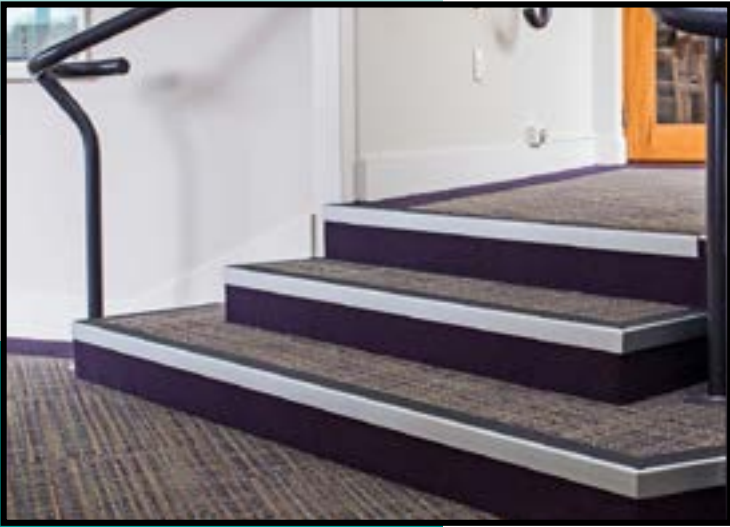

STAIR NOSING FOR CARPET

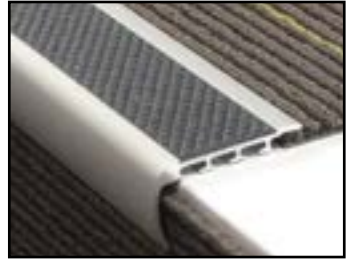

- Safety stair nosing for use with carpeted stairs.
- Tredsafe® anti-slip inserts.
- Anodized finish for durability.
- Pre-drilled and counter-sunk holes for #4 screw 82°

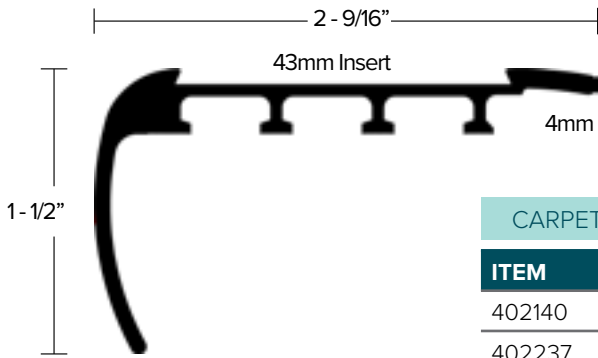

| CARPET SAFETY STAIR NOSING | | | | | |
|----------------------------|------------------|--------------|--------|-----|--------|
| ITEM | ITEM DESCRIPTION | SCREWS INCL. | LENGTH | QTY | WEIGHT |
| 402140 | AA121 EA | NO | 12' | 6 | 39 |
| 402237 | AA121 EN | NO | 12' | 6 | 39 |
| 402238 | AA121 BRZ | NO | 12' | 6 | 39 |

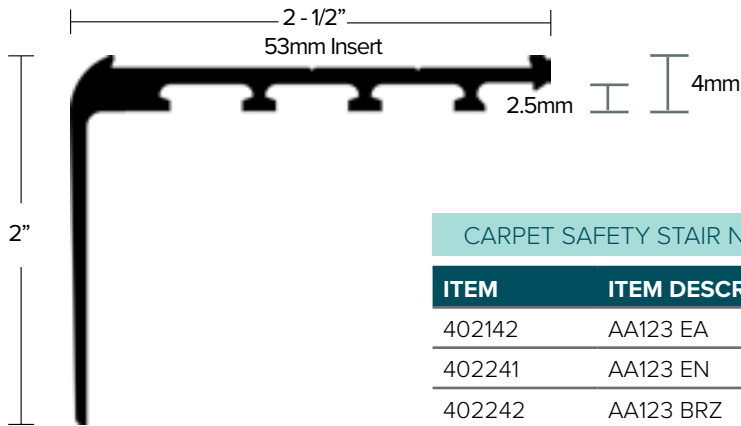

| CARPET SAFETY STAIR NOSING | | | | | |
|----------------------------|------------------|--------------|--------|-----|--------|
| ITEM | ITEM DESCRIPTION | SCREWS INCL. | LENGTH | QTY | WEIGHT |
| 402142 | AA123 EA | NO | 12' | 6 | 39 |
| 402241 | AA123 EN | NO | 12' | 6 | 39 |
| 402242 | AA123 BRZ | NO | 12' | 6 | 39 |

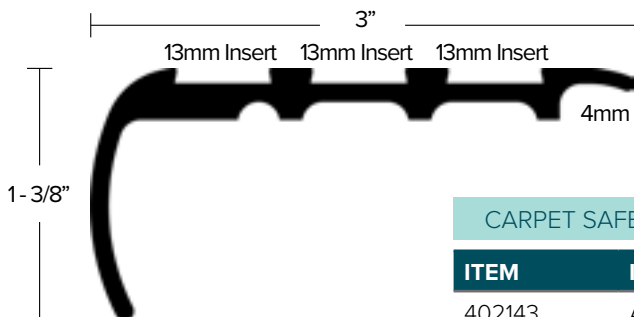

| CARPET SAFETY STAIR NOSING | | | | | |
|----------------------------|------------------|--------------|--------|-----|--------|
| ITEM | ITEM DESCRIPTION | SCREWS INCL. | LENGTH | QTY | WEIGHT |
| 402143 | AA345 EA | NO | 12' | 6 | 53 |
| 402244 | AA345 EN | NO | 12' | 6 | 53 |
| 402243 | AA345 BRZ | NO | 12' | 6 | 53 |

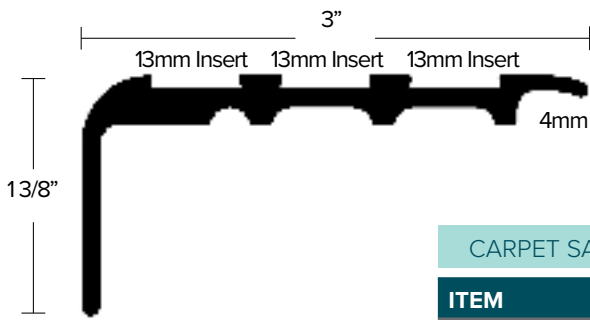

CARPET SAFETY STAIR NOSING

| ITEM | ITEM DESCRIPTION | SCREWS INCL. | LENGTH | QTY | WEIGHT |
|--------|------------------|--------------|--------|-----|--------|
| 402128 | AA346 EA | NO | 12' | 6 | 52 |
| 402245 | AA346 EN | NO | 12' | 6 | 52 |
| 402246 | AA356 BRZ | NO | 12' | 6 | 52 |



STAIR NOSING FOR CERAMIC

- Safety stair nosing for use with ceramic floor.
- Tredsafe® anti-slip inserts.
- Anodized finish for durability.
- Pre-drilled and counter-sunk holes for #4 screw 82°

SAFETY STAIR NOSING FOR CERAMIC

| ITEM | ITEM DESCRIPTION | SCREWS INCL. | LENGTH | QTY | WEIGHT |
|--------|------------------|--------------|--------|-----|--------|
| 402147 | AA351 EA | NO | 12' | 6 | 56 |
| 402248 | AA351 EN | NO | 12' | 6 | 56 |
| 402247 | AA351 BRZ | NO | 12' | 6 | 56 |

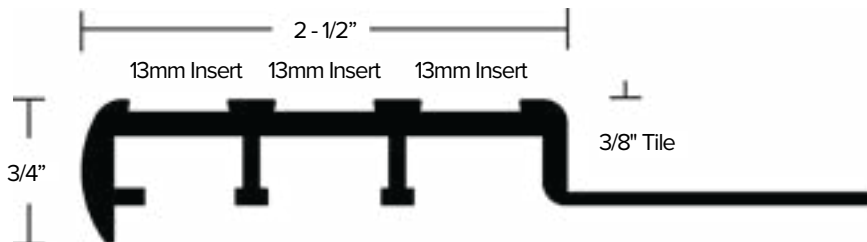

STAIR NOSING FOR BARE FLOOR

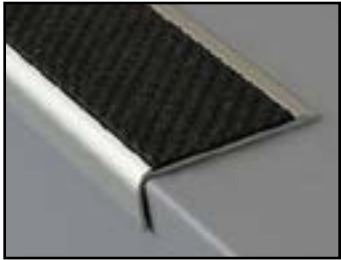

- Safety stair nosing for use with bare floor.
- Tredsafe® anti-slip inserts.
- Anodized finish for durability.
- Pre-drilled and counter-sunk holes for #4 screw 82°

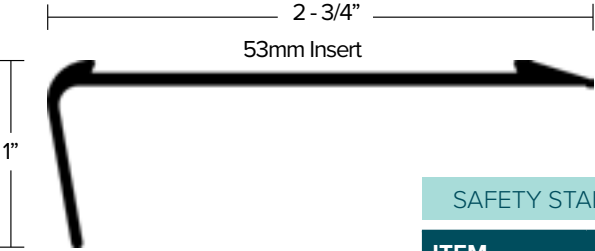

| SAFETY STAIR NOSING FOR BARE FLOOR | | | | | |
|------------------------------------|------------------|--------------|--------|-----|--------|
| ITEM | ITEM DESCRIPTION | SCREWS INCL. | LENGTH | QTY | WEIGHT |
| 402141 | AA125 EA | NO | 12' | 6 | 22 |
| 402240 | AA125 EN | NO | 12' | 6 | 22 |
| 402239 | AA125 BRZ | NO | 12' | 6 | 22 |

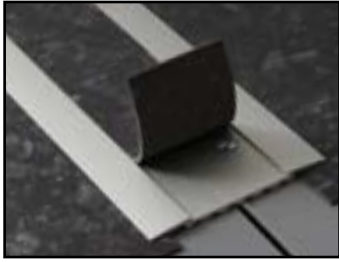

SAFETY JOINER FOR VINYL

- Safety joiner for use with 2mm sheet vinyl.
- Can be used with Tredsafe® 53mm anti-slip inserts.
- Joiner insert area can also be filled with 53mm length of 2mm vinyl for a continuous look.
- Anodized finish for durability.
- Pre-drilled and counter-sunk holes for #4 screw 82°

SAFETY JOINER

| ITEM | ITEM DESCRIPTION | SCREWS INCL. | LENGTH | QTY | WEIGHT |
|--------|------------------|--------------|--------|-----|--------|
| 402250 | DT025 EA | NO | 12' | 12 | 58 |
| 402251 | DT025 EN | NO | 12' | 12 | 58 |
| 402252 | DT025 BRZ | NO | 12' | 12 | 58 |

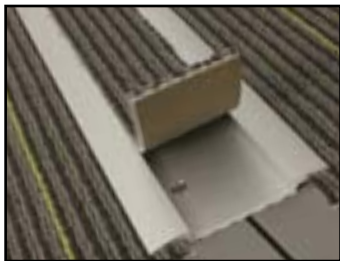
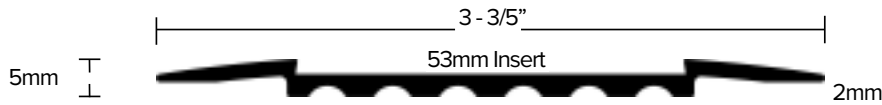

SAFETY JOINER FOR CARPET

- Safety joiner for use with carpet tile.
- Joiner insert area can be filled with 50mm length of carpet tile for a continuous look.
- Anodized finish for durability.
- Pre-drilled and counter-sunk holes for #4 screw 82°

SAFETY JOINER

| ITEM | ITEM DESCRIPTION | SCREWS INCL. | LENGTH | QTY | WEIGHT |
|--------|------------------|--------------|--------|-----|--------|
| 402283 | DT026 EA | NO | 12' | 12 | 87 |
| 402284 | DT026 EN | NO | 12' | 12 | 87 |
| 402285 | DT026 BRZ | NO | 12' | 12 | 87 |
| 402286 | DT026 EBLK | NO | 12' | 12 | 87 |

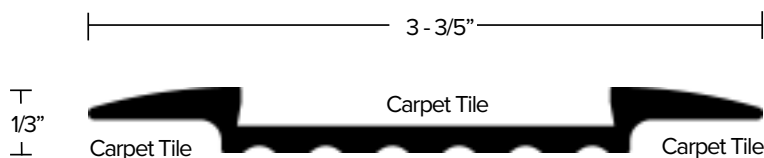

SAFETY TRANSITION FOR CARPET

- Transitions from carpet tile to various sizes of LVT and sheet vinyl
- For use with Tredsafe® 13mm anti-slip inserts.
- Anodized finish for durability.
- Pre-drilled and counter-sunk holes for #4 screw 82°

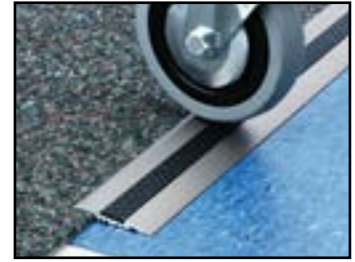

SAFETY TRANSITION 2MM SHEET VINYL OR LVT TO CARPET TILE

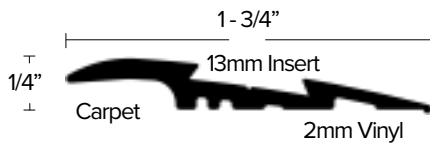

| ITEM | ITEM DESCRIPTION | SCREWS INCL. | LENGTH | QTY | WEIGHT |
|--------|------------------|--------------|--------|-----|--------|
| 402279 | DT024 EA | NO | 12' | 12 | 31 |
| 402280 | DT024 EN | NO | 12' | 12 | 31 |
| 402281 | DT024 BRZ | NO | 12' | 12 | 31 |
| 402282 | DT024 EBLK | NO | 12' | 12 | 31 |

SAFETY TRANSITION 3MM LVT TO CARPET TILE

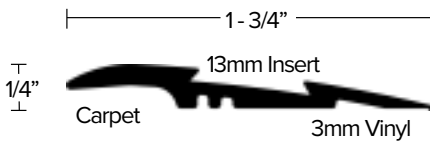

| ITEM | ITEM DESCRIPTION | SCREWS INCL. | LENGTH | QTY | WEIGHT |
|--------|------------------|--------------|--------|-----|--------|
| 402287 | DT027 EA | NO | 12' | 12 | 31 |
| 402288 | DT027 EN | NO | 12' | 12 | 31 |
| 402289 | DT027 BRZ | NO | 12' | 12 | 31 |
| 402290 | DT027 EBLK | NO | 12' | 12 | 31 |

SAFETY TRANSITION BARE FLOOR TO CARPET TILE

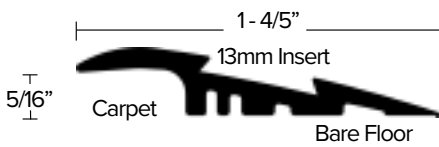

| ITEM | ITEM DESCRIPTION | SCREWS INCL. | LENGTH | QTY | WEIGHT |
|--------|------------------|--------------|--------|-----|--------|
| 402291 | DT028 EA | NO | 12' | 12 | 37 |
| 402292 | DT028 EN | NO | 12' | 12 | 37 |
| 402293 | DT028 BRZ | NO | 12' | 12 | 37 |
| 402294 | DT028 EBLK | NO | 12' | 12 | 37 |

SAFETY TRANSITION 5MM LVT TO CARPET TILE

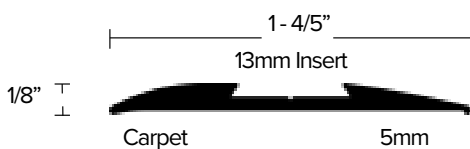

| ITEM | ITEM DESCRIPTION | SCREWS INCL. | LENGTH | QTY | WEIGHT |
|--------|------------------|--------------|--------|-----|--------|
| 402295 | DT029 EA | NO | 12' | 12 | 28 |
| 402296 | DT029 EN | NO | 12' | 12 | 28 |
| 402297 | DT029 BRZ | NO | 12' | 12 | 28 |
| 402298 | DT029 EBLK | NO | 12' | 12 | 28 |

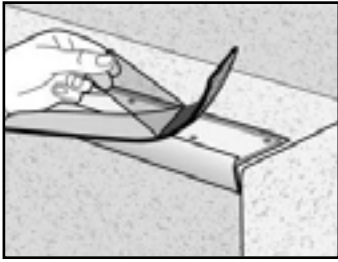

TREDSAFE® INSERTS

Tredsafe insert is manufactured from a special blend of PVC, silica quartz and polymeric plasticiser giving an homogeneous hard wearing anti-slip flooring for wet and dry conditions. Tredsafe insert is resistant to attack from ultraviolet light, oil, grease, gasoline, salt, dilute acids and alkalies, common household chemicals and detergents. Organic solvents will soften Tredsafe insert. Suitable for interior or exterior use.

TREDSAFE INSERTS

| ITEM | ITEM DESCRIPTION | WIDTH | LENGTH | QTY |
|--------|------------------|-------|--------|-----|
| 402164 | NEUTRAL BLACK | 13MM | 36 | 6 |
| 402165 | NEUTRAL BLACK | 43MM | 12 | 6 |
| 402167 | NEUTRAL BLACK | 53MM | 12 | 6 |
| 402168 | SAFETY ORANGE | 13MM | 12 | 6 |
| 402169 | SAFETY ORANGE | 43MM | 12 | 6 |
| 402170 | SAFETY ORANGE | 53MM | 12 | 6 |
| 402171 | SIGNAL YELLOW | 13MM | 12 | 6 |
| 402172 | SIGNAL YELLOW | 43MM | 12 | 6 |
| 402173 | SIGNAL YELLOW | 53MM | 12 | 6 |
| 402192 | MID GREY | 13MM | 12 | 6 |
| 402193 | MID GREY | 43MM | 12 | 6 |
| 402194 | MID GREY | 53MM | 12 | 6 |
| 402201 | RICH BROWN | 13MM | 12 | 6 |
| 402202 | RICH BROWN | 43MM | 12 | 6 |
| 402203 | RICH BROWN | 53MM | 12 | 6 |
| 402186 | CHARCOAL | 13MM | 12 | 6 |
| 402187 | CHARCOAL | 43MM | 12 | 6 |
| 402188 | CHARCOAL | 53MM | 12 | 6 |

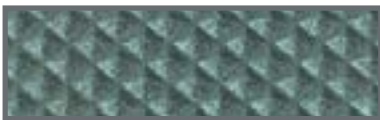

SPECIAL ORDER TREDSAFE® INSERTS

For more color options see the complete line of Tredsafe insert colors below including luminescent "glow-in-the-dark" inserts. For larger projects, custom colors can easily be created.

Please note that special order Tredsafe inserts have longer lead times.



| SPECIAL ORDER TREDSAFE INSERTS | | | | |
|--------------------------------|------------------|-------|--------|-----|
| ITEM | ITEM DESCRIPTION | WIDTH | LENGTH | QTY |
| 402174 | SAFETY WHITE | 13MM | 12 | 6 |
| 402175 | SAFETY WHITE | 43MM | 12 | 6 |
| 402176 | SAFETY WHITE | 53MM | 12 | 6 |
| 402177 | SAFETY BLUE | 13MM | 12 | 6 |
| 402178 | SAFETY BLUE | 43MM | 12 | 6 |
| 402179 | SAFETY BLUE | 53MM | 12 | 6 |
| 402180 | SAFETY GREEN | 13MM | 12 | 6 |
| 402181 | SAFETY GREEN | 43MM | 12 | 6 |
| 402182 | SAFETY GREEN | 53MM | 12 | 6 |
| 402183 | SAFETY RED | 13MM | 12 | 6 |
| 402184 | SAFETY RED | 43MM | 12 | 6 |
| 402185 | SAFETY RED | 53MM | 12 | 6 |
| 402189 | LIGHT GREY | 13MM | 12 | 6 |
| 402190 | LIGHT GREY | 43MM | 12 | 6 |
| 402191 | LIGHT GREY | 53MM | 12 | 6 |
| 402216 | LUMITRED | 13MM | 12 | 6 |
| 402217 | LUMITRED | 43MM | 12 | 6 |
| 402218 | LUMITRED | 53MM | 12 | 6 |



INSTALLATION OF TREDSAFE® INSERTS

Step 1

Ensure the aluminum channel is clean from dust, residues and debris. Wipe down with a cleaning solvent (Isopropyl Alcohol or similar).

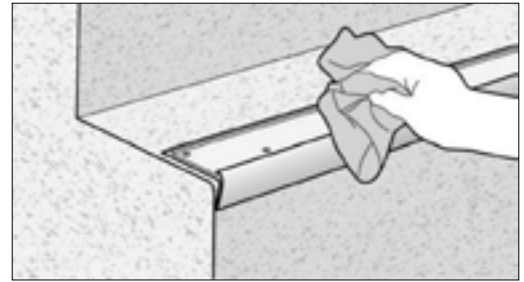

Step 2

Precut the Insert to your required length.

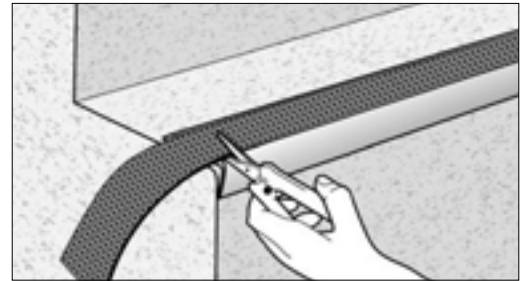

Step 3

Remove the adhesive backing liner from the Tredsafe® Insert.

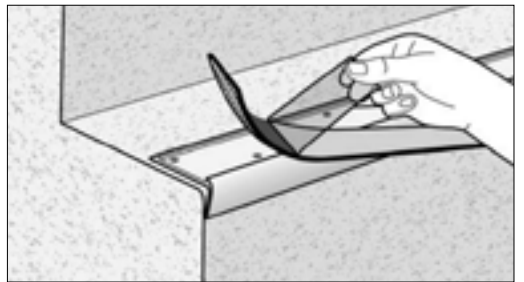

Step 4

Install by placing the Insert into the nosing and pressing into place without undue stretching.

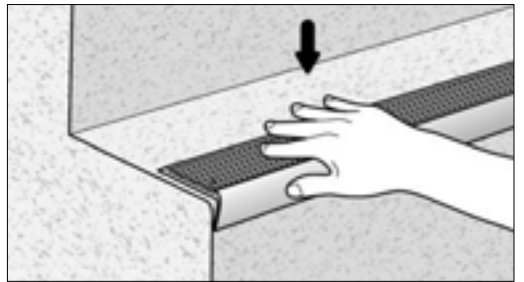

Step 5

Once in place, roll over the Insert to ensure consistent adhesion and a secure bond. Please take care not to stretch the Insert when rolling. Installation is now complete.

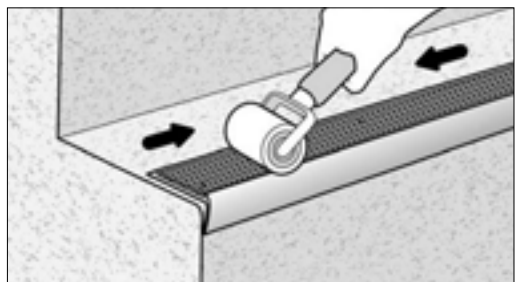

LVT TRIMS & TRANSITIONS

 Designer trims made to protect and enhance your flooring investment. Introducing our latest line of commercial and residential trims and transitions made specifically for the expanding LVT/Resilient market.



NO-LIP RAMPS & JOINERS

- Transition from LVT to carpet tile.
- Transition from LVT to nothing.
- Transition from LVT or other resilient of different size.
- Joiner from LVT or other resilient of same size.

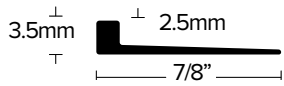

2.5MM to 3.5MM LVT NO-LIP RAMP

| ITEM | ITEM DESCRIPTION | NAILS INCL. | LENGTH | QTY | WEIGHT |
|--------|------------------|-------------|--------|-----|--------|
| 402079 | LVT 123 MF | NO | 12' | 24 | 25 |

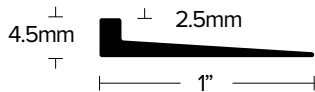

2.5MM to 4.5MM LVT NO-LIP RAMP

| ITEM | ITEM DESCRIPTION | NAILS INCL. | LENGTH | QTY | WEIGHT |
|--------|------------------|-------------|--------|-----|--------|
| 402052 | LVT 124 MF | NO | 12' | 24 | 25 |

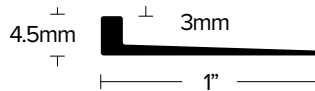

3MM to 4.5MM LVT NO-LIP RAMP

| ITEM | ITEM DESCRIPTION | NAILS INCL. | LENGTH | QTY | WEIGHT |
|--------|------------------|-------------|--------|-----|--------|
| 402021 | LVT 125 MF | NO | 12' | 24 | 25 |
| 402088 | LVT 125 EN | NO | 12' | 24 | 25 |
| 402089 | LVT 125 BRZ | NO | 12' | 24 | 25 |
| 510127 | LVT 125 MF-FLEX | NO | 12' | 24 | 25 |

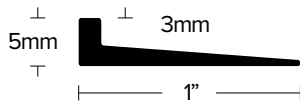

3MM to 5MM LVT NO-LIP RAMP

| ITEM | ITEM DESCRIPTION | NAILS INCL. | LENGTH | QTY | WEIGHT |
|--------|------------------|-------------|--------|-----|--------|
| 402051 | LVT 127 MF | NO | 12' | 24 | 26 |

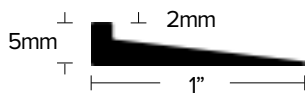

2MM to 5MM LVT NO-LIP RAMP

| ITEM | ITEM DESCRIPTION | NAILS INCL. | LENGTH | QTY | WEIGHT |
|--------|------------------|-------------|--------|-----|--------|
| 402272 | LVT 118 MF | NO | 12' | 24 | 31 |

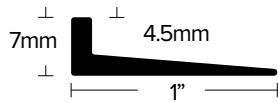

4.5MM to 7MM LVT RAMP

| ITEM | ITEM DESCRIPTION | NAILS INCL. | LENGTH | QTY | WEIGHT |
|--------|------------------|-------------|--------|-----|--------|
| 402081 | LVT 121 MF | NO | 12' | 24 | 33 |

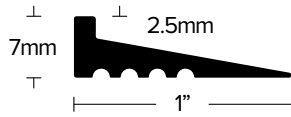

2.5MM to 7MM LVT RAMP

| ITEM | ITEM DESCRIPTION | NAILS INCL. | LENGTH | QTY | WEIGHT |
|--------|------------------|-------------|--------|-----|--------|
| 402078 | LVT 129 MF | NO | 12' | 24 | 38 |

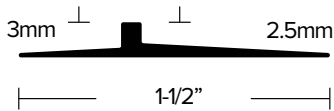

2.5MM to 3MM LVT NO-LIP JOINER

| ITEM | ITEM DESCRIPTION | NAILS INCL. | LENGTH | QTY | WEIGHT |
|--------|------------------|-------------|--------|-----|--------|
| 402077 | LVT 128 MF | NO | 12' | 24 | 28 |

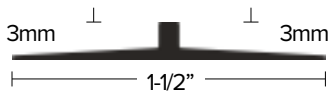

3MM to 3MM LVT NO-LIP JOINER

| ITEM | ITEM DESCRIPTION | NAILS INCL. | LENGTH | QTY | WEIGHT |
|--------|------------------|-------------|--------|-----|--------|
| 402093 | LVT 133 MF | NO | 12' | 24 | 28 |

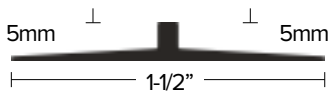

5MM to 5MM LVT NO-LIP JOINER

| ITEM | ITEM DESCRIPTION | NAILS INCL. | LENGTH | QTY | WEIGHT |
|--------|------------------|-------------|--------|-----|--------|
| 402094 | LVT 155 MF | NO | 12' | 24 | 30 |
| 402256 | LVT 155 EN | NO | 12' | 24 | 30 |
| 402255 | LVT 155 BRZ | NO | 12' | 24 | 30 |

14MM to 6MM LVT RAMP

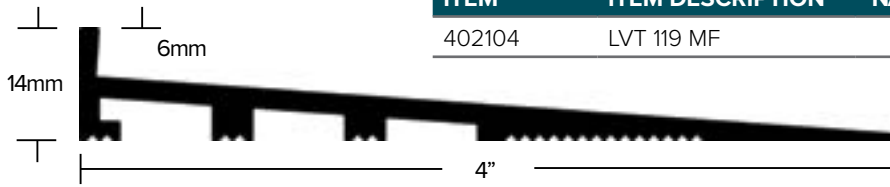

| ITEM | ITEM DESCRIPTION | NAILS INCL. | LENGTH | QTY | WEIGHT |
|--------|------------------|-------------|--------|-----|--------|
| 402104 | LVT 119 MF | NO | 12' | 6 | 47 |

15MM to 4.5MM LVT RAMP

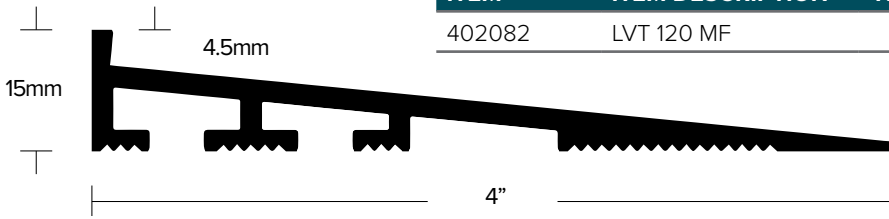

| ITEM | ITEM DESCRIPTION | NAILS INCL. | LENGTH | QTY | WEIGHT |
|--------|------------------|-------------|--------|-----|--------|
| 402082 | LVT 120 MF | NO | 12' | 6 | 51 |

15MM to 7MM LVT RAMP

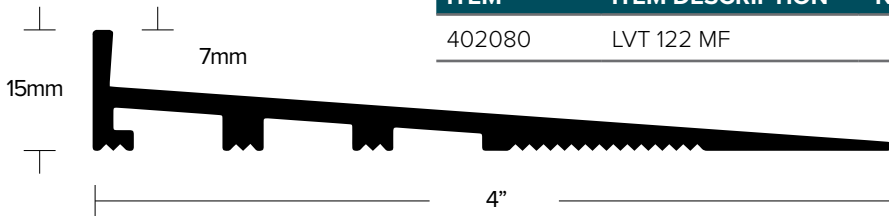

| ITEM | ITEM DESCRIPTION | NAILS INCL. | LENGTH | QTY | WEIGHT |
|--------|------------------|-------------|--------|-----|--------|
| 402080 | LVT 122 MF | NO | 12' | 6 | 47 |

15MM to 3MM LVT RAMP

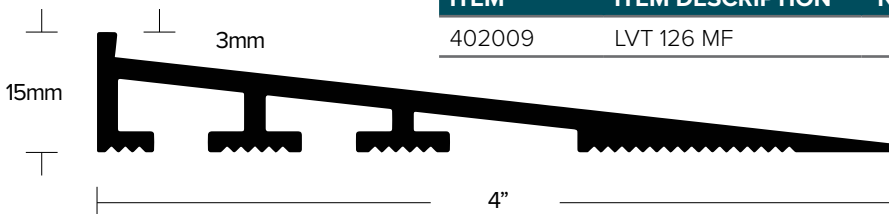

| ITEM | ITEM DESCRIPTION | NAILS INCL. | LENGTH | QTY | WEIGHT |
|--------|------------------|-------------|--------|-----|--------|
| 402009 | LVT 126 MF | NO | 12' | 6 | 57 |



CARPET TILE TO LVT

- Transitions from carpet tile to LVT of 3 or 5 mm height.

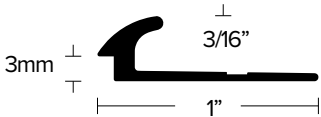

| 3MM LVT TO CARPET TILE | | | | | |
|------------------------|------------------|-------------|--------|-----|--------|
| ITEM | ITEM DESCRIPTION | NAILS INCL. | LENGTH | QTY | WEIGHT |
| 402000 | LVT 130 EA | NO | 12' | 24 | 31 |
| 402001 | LVT 130 EN | NO | 12' | 24 | 31 |
| 402002 | LVT 130 BRZ | NO | 12' | 24 | 31 |
| 402269 | LVT 130 EBLK | NO | 12' | 24 | 31 |
| 510118 | LVT 130 EA-FLEX | NO | 12' | 24 | 31 |
| 510119 | LVT 130 EN-FLEX | NO | 12' | 24 | 31 |
| 510120 | LVT 130 BRZ-FLEX | NO | 12' | 24 | 31 |

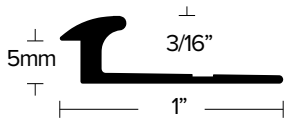

| 5MM LVT TO CARPET TILE | | | | | |
|------------------------|------------------|-------------|--------|-----|--------|
| ITEM | ITEM DESCRIPTION | NAILS INCL. | LENGTH | QTY | WEIGHT |
| 402003 | LVT 150 EA | NO | 12' | 24 | 32 |
| 402004 | LVT 150 EN | NO | 12' | 24 | 32 |
| 402005 | LVT 150 BRZ | NO | 12' | 24 | 32 |
| 402270 | LVT 150 EBLK | NO | 12' | 24 | 32 |
| 510121 | LVT 150 EA-FLEX | NO | 12' | 24 | 32 |
| 510122 | LVT 150 EN-FLEX | NO | 12' | 24 | 32 |
| 510123 | LVT 150 BRZ-FLEX | NO | 12' | 24 | 32 |



| 3MM LVT TO CARPET TILE (EXTENDED LIP) | | | | | |
|---------------------------------------|------------------|-------------|--------|-----|--------|
| ITEM | ITEM DESCRIPTION | NAILS INCL. | LENGTH | QTY | WEIGHT |
| 402101 | LVT 131 EA | NO | 12' | 24 | 36 |
| 402102 | LVT 131 EN | NO | 12' | 24 | 36 |
| 402103 | LVT 131 BRZ | NO | 12' | 24 | 36 |

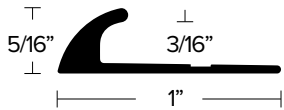

CARPET TILE TO LVT/NOTHING

| ITEM | ITEM DESCRIPTION | NAILS INCL. | LENGTH | QTY | WEIGHT |
|--------|------------------|-------------|--------|-----|--------|
| 402006 | LVT 160 EA | NO | 12' | 24 | 34 |
| 402007 | LVT 160 EN | NO | 12' | 24 | 34 |
| 402008 | LVT 160 BRZ | NO | 12' | 24 | 34 |
| 402271 | LVT 160 EBLK | NO | 12' | 24 | 34 |
| 510124 | LVT 160 EA-FLEX | NO | 12' | 24 | 34 |
| 510125 | LVT 160 EN-FLEX | NO | 12' | 24 | 34 |
| 510126 | LVT 160 BRZ-FLEX | NO | 12' | 24 | 34 |

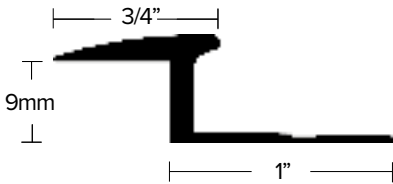

CARPET TO 9MM

| ITEM | ITEM DESCRIPTION | NAILS INCL. | LENGTH | QTY | WEIGHT |
|--------|------------------|-------------|--------|-----|--------|
| 402096 | LVT 190 EA | NO | 12' | 12 | 25 |
| 402097 | LVT 190 EN | NO | 12' | 12 | 25 |
| 402098 | LVT 190 BRZ | NO | 12' | 12 | 25 |

3MM LVT TO CARPET TILE

| ITEM | ITEM DESCRIPTION | NAILS INCL. | LENGTH | QTY | WEIGHT |
|--------|------------------|-------------|--------|-----|--------|
| 402010 | LVT 350 BREA | NO | 12' | 40 | 143 |





NO-LIP STAIR NOSING

- LVT transitions for both the inside and outside corners of stairs.
- LVT transitions for both inside and outside corners of wall applications.

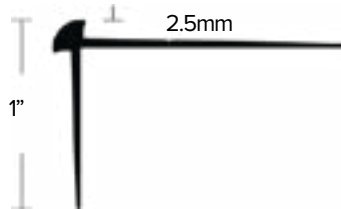

| 2.5MM NO-LIP STAIR NOSING | | | | | |
|---------------------------|------------------|-------------|--------|-----|--------|
| ITEM | ITEM DESCRIPTION | NAILS INCL. | LENGTH | QTY | WEIGHT |
| 402134 | LVT 325 EA | NO | 12' | 12 | 24 |
| 402139 | LVT 325 EN | NO | 12' | 12 | 24 |
| 402144 | LVT 325 BRZ | NO | 12' | 12 | 24 |

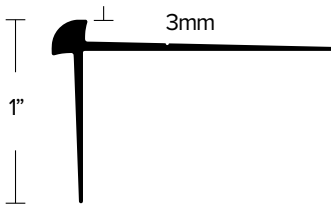

| 3MM NO-LIP STAIR NOSING | | | | | |
|-------------------------|------------------|-------------|--------|-----|--------|
| ITEM | ITEM DESCRIPTION | NAILS INCL. | LENGTH | QTY | WEIGHT |
| 402018 | LVT 340 EA | NO | 12' | 12 | 24 |
| 402019 | LVT 340 EN | NO | 12' | 12 | 24 |
| 402020 | LVT 340 BRZ | NO | 12' | 12 | 24 |

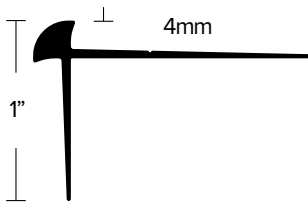

| 4MM NO-LIP STAIR NOSING | | | | | |
|-------------------------|------------------|-------------|--------|-----|--------|
| ITEM | ITEM DESCRIPTION | NAILS INCL. | LENGTH | QTY | WEIGHT |
| 402083 | LVT 343 EA | NO | 12' | 12 | 26 |
| 402084 | LVT 343 EN | NO | 12' | 12 | 26 |
| 402085 | LVT 343 BRZ | NO | 12' | 12 | 26 |

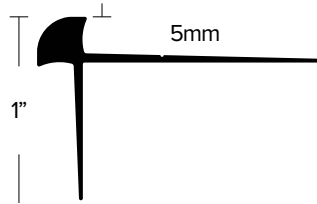

5MM NO-LIP STAIR NOSING

| ITEM | ITEM DESCRIPTION | NAILS INCL. | LENGTH | QTY | WEIGHT |
|--------|------------------|-------------|--------|-----|--------|
| 402046 | LVT 341 EA | NO | 12' | 12 | 28 |
| 402047 | LVT 341 EN | NO | 12' | 12 | 28 |
| 402048 | LVT 341 BRZ | NO | 12' | 12 | 28 |

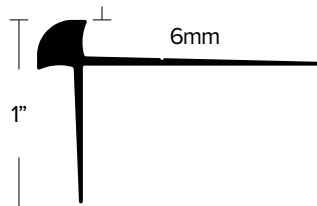

6MM NO-LIP STAIR NOSING

| ITEM | ITEM DESCRIPTION | NAILS INCL. | LENGTH | QTY | WEIGHT |
|--------|------------------|-------------|--------|-----|--------|
| 402226 | LVT 346 EA | NO | 12' | 12 | 28 |
| 402227 | LVT 346 EN | NO | 12' | 12 | 28 |
| 402228 | LVT 346 BRZ | NO | 12' | 12 | 28 |

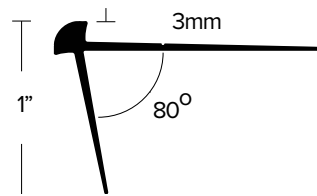

3MM NO-LIP STAIR NOSING 80° ANGLE

| ITEM | ITEM DESCRIPTION | NAILS INCL. | LENGTH | QTY | WEIGHT |
|--------|------------------|-------------|--------|-----|--------|
| 402011 | LVT 342 EA | NO | 12' | 12 | 24 |
| 402012 | LVT 342 EN | NO | 12' | 12 | 24 |
| 402013 | LVT 342 BRZ | NO | 12' | 12 | 24 |

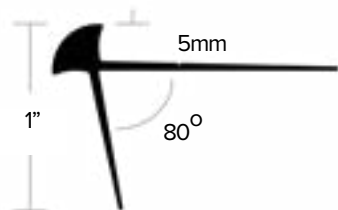

5MM NO-LIP STAIR NOSING 80° ANGLE

| ITEM | ITEM DESCRIPTION | NAILS INCL. | LENGTH | QTY | WEIGHT |
|--------|------------------|-------------|--------|-----|--------|
| 402220 | LVT 347 EA | NO | 12' | 12 | 24 |
| 402221 | LVT 347 EN | NO | 12' | 12 | 24 |
| 402222 | LVT 347 BRZ | NO | 12' | 12 | 24 |

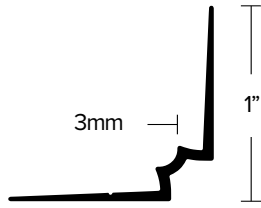

| 3MM NO-LIP STAIR RISER | | | | | |
|------------------------|------------------|-------------|--------|-----|--------|
| ITEM | ITEM DESCRIPTION | NAILS INCL. | LENGTH | QTY | WEIGHT |
| 402015 | LVT 330 EA | NO | 12' | 12 | 18 |
| 402016 | LVT 330 EN | NO | 12' | 12 | 18 |
| 402017 | LVT 330 BRZ | NO | 12' | 12 | 18 |

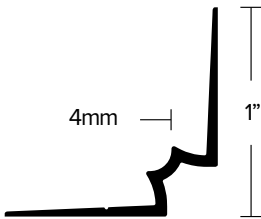

| 4MM NO-LIP STAIR RISER | | | | | |
|------------------------|------------------|-------------|--------|-----|--------|
| ITEM | ITEM DESCRIPTION | NAILS INCL. | LENGTH | QTY | WEIGHT |
| 508735 | LVT 333 EA | NO | 12' | 12 | 19 |
| 508736 | LVT 333 EN | NO | 12' | 12 | 19 |
| 508737 | LVT 333 BRZ | NO | 12' | 12 | 19 |

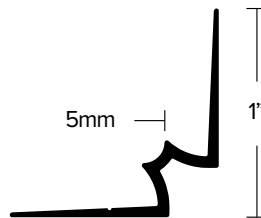

| 5MM NO-LIP STAIR RISER | | | | | |
|------------------------|------------------|-------------|--------|-----|--------|
| ITEM | ITEM DESCRIPTION | NAILS INCL. | LENGTH | QTY | WEIGHT |
| 402014 | LVT 331 EA | NO | 12' | 12 | 19 |
| 402049 | LVT 331 EN | NO | 12' | 12 | 19 |
| 402050 | LVT 331 BRZ | NO | 12' | 12 | 19 |

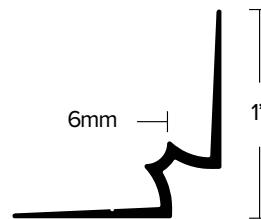

| 6MM NO-LIP STAIR RISER | | | | | |
|------------------------|------------------|-------------|--------|-----|--------|
| ITEM | ITEM DESCRIPTION | NAILS INCL. | LENGTH | QTY | WEIGHT |
| 402231 | LVT 336 EA | NO | 12' | 12 | 19 |
| 402230 | LVT 336 EN | NO | 12' | 12 | 19 |
| 402229 | LVT 336 BRZ | NO | 12' | 12 | 19 |

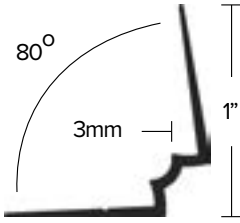

3MM NO-LIP STAIR RISER 80° ANGLE

| ITEM | ITEM DESCRIPTION | NAILS INCL. | LENGTH | QTY | WEIGHT |
|--------|------------------|-------------|--------|-----|--------|
| 402095 | LVT 332 EA | NO | 12' | 12 | 19 |
| 402099 | LVT 332 EN | NO | 12' | 12 | 19 |
| 402100 | LVT 332 BRZ | NO | 12' | 12 | 19 |

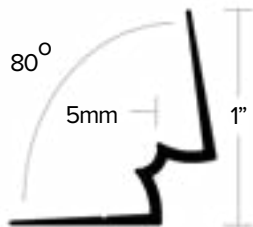

5MM NO-LIP STAIR RISER 80° ANGLE

| ITEM | ITEM DESCRIPTION | NAILS INCL. | LENGTH | QTY | WEIGHT |
|--------|------------------|-------------|--------|-----|--------|
| 402225 | LVT 337 EA | NO | 12' | 12 | 19 |
| 402224 | LVT 337 EN | NO | 12' | 12 | 19 |
| 402223 | LVT 337 BRZ | NO | 12' | 12 | 19 |



STAIR NOSING

- Two different drops, 1-5/8" and 2"
- Available in various sizes

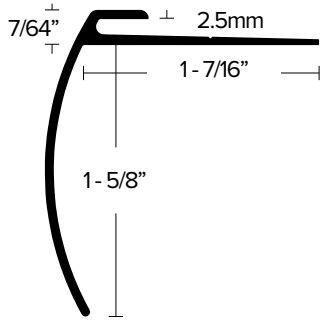

2.5MM LVT STAIR NOSING

| ITEM | ITEM DESCRIPTION | NAILS INCL. | LENGTH | QTY | WEIGHT |
|--------|------------------|-------------|--------|-----|--------|
| 402037 | LVT 625 EA | NO | 12' | 12 | 36 |
| 402038 | LVT 625 EN | NO | 12' | 12 | 36 |
| 402039 | LVT 625 BRZ | NO | 12' | 12 | 36 |
| 402268 | LVT 625 EBLK | NO | 12' | 12 | 36 |

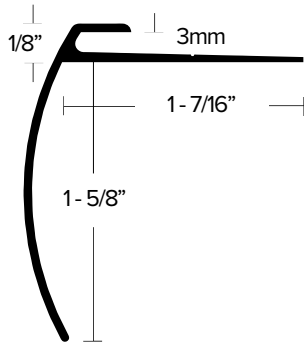

3MM LVT STAIR NOSING

| ITEM | ITEM DESCRIPTION | NAILS INCL. | LENGTH | QTY | WEIGHT |
|--------|------------------|-------------|--------|-----|--------|
| 402040 | LVT 630 EA | NO | 12' | 12 | 37 |
| 402041 | LVT 630 EN | NO | 12' | 12 | 37 |
| 402042 | LVT 630 BRZ | NO | 12' | 12 | 37 |

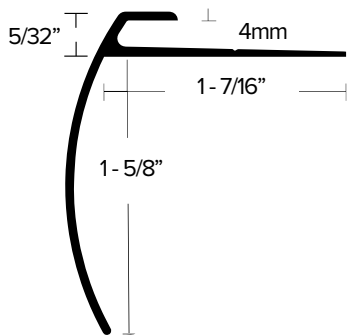

4MM LVT STAIR NOSING

| ITEM | ITEM DESCRIPTION | NAILS INCL. | LENGTH | QTY | WEIGHT |
|--------|------------------|-------------|--------|-----|--------|
| 401176 | LVT 606 EA | NO | 12' | 12 | 37 |
| 401177 | LVT 606 EN | NO | 12' | 12 | 37 |
| 401175 | LVT 606 BRZ | NO | 12' | 12 | 37 |

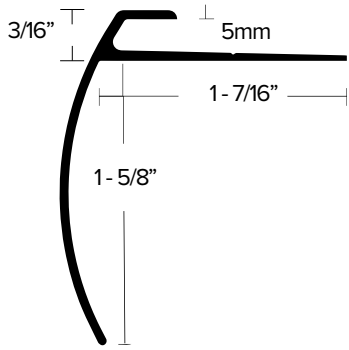

| 5MM LVT STAIR NOSING | | | | | |
|----------------------|------------------|-------------|--------|-----|--------|
| ITEM | ITEM DESCRIPTION | NAILS INCL. | LENGTH | QTY | WEIGHT |
| 389141 | LVT 608 EA | NO | 12' | 12 | 37 |
| 389143 | LVT 608 EN | NO | 12' | 12 | 37 |
| 390168 | LVT 608 BRZ | NO | 12' | 12 | 37 |
| 389142 | LVT 608 EB | NO | 12' | 12 | 37 |
| 402273 | LVT 608 EBLK | NO | 12' | 12 | 37 |

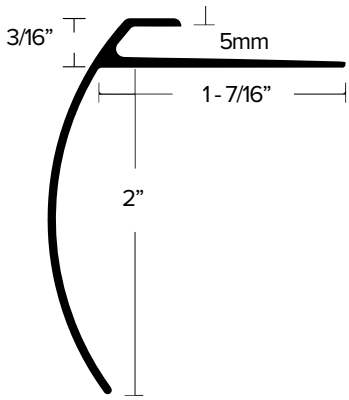

| 5MM LVT STAIR NOSING LONG | | | | | |
|---------------------------|------------------|-------------|--------|-----|--------|
| ITEM | ITEM DESCRIPTION | NAILS INCL. | LENGTH | QTY | WEIGHT |
| 401178 | LVT 610 EA | NO | 12' | 12 | 41 |
| 401179 | LVT 610 EN | NO | 12' | 12 | 41 |
| 401180 | LVT 610 BRZ | NO | 12' | 12 | 41 |

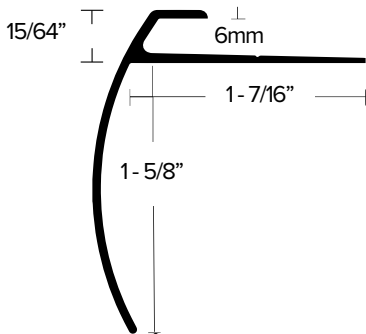

| 6MM LVT STAIR NOSING | | | | | |
|----------------------|------------------|-------------|--------|-----|--------|
| ITEM | ITEM DESCRIPTION | NAILS INCL. | LENGTH | QTY | WEIGHT |
| 401197 | LVT 604 EA | NO | 12' | 12 | 37 |
| 401198 | LVT 604 EN | NO | 12' | 12 | 37 |
| 401196 | LVT 604 BRZ | NO | 12' | 12 | 37 |

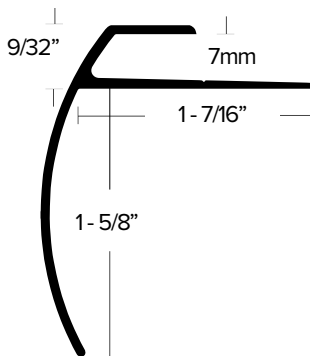

| 7MM LVT STAIR NOSING WITH EXTENDED LIP | | | | | |
|--|------------------|-------------|--------|-----|--------|
| ITEM | ITEM DESCRIPTION | NAILS INCL. | LENGTH | QTY | WEIGHT |
| 402043 | LVT 612 EA | NO | 12' | 12 | 40 |
| 402044 | LVT 612 EN | NO | 12' | 12 | 40 |
| 402045 | LVT 612 BRZ | NO | 12' | 12 | 40 |

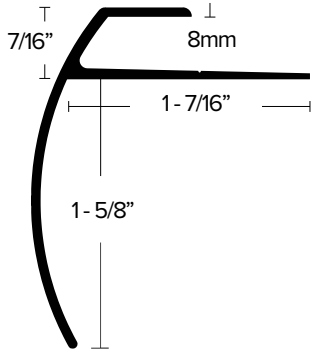

8MM LVT STAIR NOSING WITH EXTENDED LIP

| ITEM | ITEM DESCRIPTION | NAILS INCL. | LENGTH | QTY | WEIGHT |
|--------|------------------|-------------|--------|-----|--------|
| 402059 | LVT 618 EA | NO | 12' | 12 | 40 |
| 402060 | LVT 618 EN | NO | 12' | 12 | 40 |
| 402061 | LVT 618 BRZ | NO | 12' | 12 | 40 |

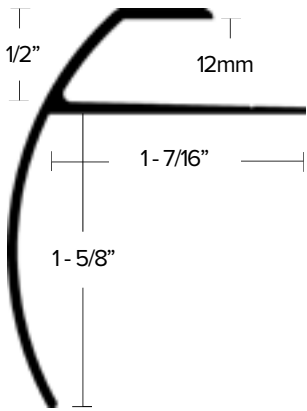

12MM LVT STAIR NOSING WITH EXTENDED LIP

| ITEM | ITEM DESCRIPTION | NAILS INCL. | LENGTH | QTY | WEIGHT |
|--------|------------------|-------------|--------|-----|--------|
| 402278 | LVT 622 EA | NO | 12' | 12 | 41 |
| 402299 | LVT 622 EN | NO | 12' | 12 | 41 |
| 402300 | LVT 622 BRZ | NO | 12' | 12 | 41 |
| 402301 | LVT 622 EBLK | NO | 12' | 12 | 41 |



BEVEL CAPS

- Can be used as end cap in wall application.

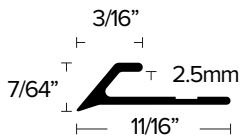

2.5MM BEVEL CAP

| ITEM | ITEM DESCRIPTION | NAILS INCL. | LENGTH | QTY | WEIGHT |
|--------|------------------|-------------|--------|-----|--------|
| 402022 | LVT 425 EA | NO | 12' | 24 | 18 |
| 402023 | LVT 425 EN | NO | 12' | 24 | 18 |
| 402024 | LVT 425 BRZ | NO | 12' | 24 | 18 |

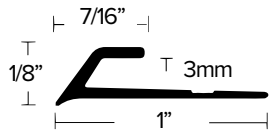

3MM BEVEL CAP

| ITEM | ITEM DESCRIPTION | NAILS INCL. | LENGTH | QTY | WEIGHT |
|--------|------------------|-------------|--------|-----|--------|
| 390156 | LVT 406 EA | NO | 12' | 24 | 26 |
| 390157 | LVT 406 EN | NO | 12' | 24 | 26 |
| 390158 | LVT 406 BRZ | NO | 12' | 24 | 26 |

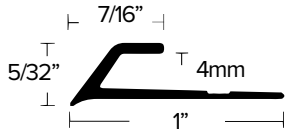

4MM BEVEL CAP

| ITEM | ITEM DESCRIPTION | NAILS INCL. | LENGTH | QTY | WEIGHT |
|--------|------------------|-------------|--------|-----|--------|
| 390153 | LVT 404 EA | NO | 12' | 24 | 27 |
| 390154 | LVT 404 EN | NO | 12' | 24 | 27 |
| 390155 | LVT 404 BRZ | NO | 12' | 24 | 27 |

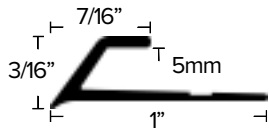

5MM BEVEL CAP

| ITEM | ITEM DESCRIPTION | NAILS INCL. | LENGTH | QTY | WEIGHT |
|--------|------------------|-------------|--------|-----|--------|
| 390159 | LVT 405 EA | NO | 12' | 24 | 28 |
| 390160 | LVT 405 EN | NO | 12' | 24 | 28 |
| 390161 | LVT 405 BRZ | NO | 12' | 24 | 28 |

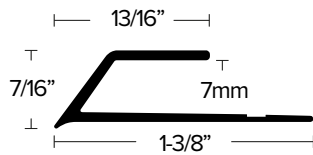

7MM BEVEL CAP EXTENDED LIP

| ITEM | ITEM DESCRIPTION | NAILS INCL. | LENGTH | QTY | WEIGHT |
|--------|------------------|-------------|--------|-----|--------|
| 402025 | LVT 407 EA | NO | 12' | 24 | 41 |
| 402026 | LVT 407 EN | NO | 12' | 24 | 41 |
| 402027 | LVT 407 BRZ | NO | 12' | 24 | 41 |

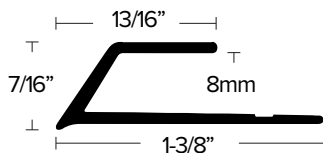

8MM BEVEL CAP EXTENDED LIP

| ITEM | ITEM DESCRIPTION | NAILS INCL. | LENGTH | QTY | WEIGHT |
|--------|------------------|-------------|--------|-----|--------|
| 402071 | LVT 408 EA | NO | 12' | 24 | 41 |
| 402072 | LVT 408 EN | NO | 12' | 24 | 41 |
| 402073 | LVT 408 BRZ | NO | 12' | 24 | 41 |



SQUARE CAPS

- Transitions from LVT to ceramic tile, wood or other surfaces of equal height.
- Can be used as end cap in wall application or LVT to fixture such as bathtub or vanity

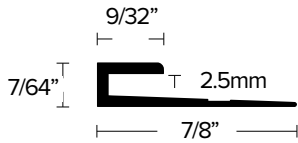

2.5MM SQUARE CAP

| ITEM | ITEM DESCRIPTION | NAILS INCL. | LENGTH | QTY | WEIGHT |
|--------|------------------|-------------|--------|-----|--------|
| 402028 | LVT 925 EA | NO | 12' | 24 | 23 |
| 402029 | LVT 925 EN | NO | 12' | 24 | 23 |
| 402030 | LVT 925 BRZ | NO | 12' | 24 | 23 |

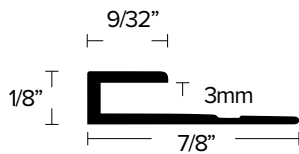

3MM SQUARE CAP

| ITEM | ITEM DESCRIPTION | NAILS INCL. | LENGTH | QTY | WEIGHT |
|--------|------------------|-------------|--------|-----|--------|
| 402031 | LVT 906 EA | NO | 12' | 24 | 23 |
| 402032 | LVT 906 EN | NO | 12' | 24 | 23 |
| 402033 | LVT 906 BRZ | NO | 12' | 24 | 23 |

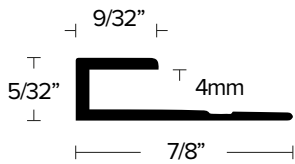

4MM SQUARE CAP

| ITEM | ITEM DESCRIPTION | NAILS INCL. | LENGTH | QTY | WEIGHT |
|--------|------------------|-------------|--------|-----|--------|
| 403263 | LVT 904 EA | NO | 12' | 24 | 22 |
| 403264 | LVT 904 EN | NO | 12' | 24 | 22 |
| 403265 | LVT 904 BRZ | NO | 12' | 24 | 22 |

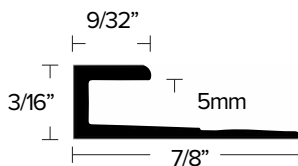

5MM SQUARE CAP

| ITEM | ITEM DESCRIPTION | NAILS INCL. | LENGTH | QTY | WEIGHT |
|--------|------------------|-------------|--------|-----|--------|
| 403262 | LVT 905 EA | NO | 12' | 24 | 22 |
| 403261 | LVT 905 EN | NO | 12' | 24 | 22 |
| 403260 | LVT 905 BRZ | NO | 12' | 24 | 22 |
| 402267 | LVT 905 EBLK | NO | 12' | 24 | 22 |



5MM SQUARE CAP EXTENDED LIP

| ITEM | ITEM DESCRIPTION | NAILS INCL. | LENGTH | QTY | WEIGHT |
|--------|------------------|-------------|--------|-----|--------|
| 402157 | LVT 915 EA | NO | 12' | 24 | 33 |
| 402156 | LVT 915 EN | NO | 12' | 24 | 33 |
| 402155 | LVT 915 BRZ | NO | 12' | 24 | 33 |

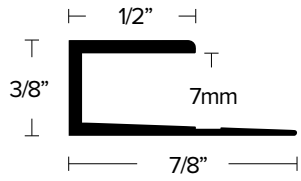

7MM SQUARE CAP EXTENDED LIP

| ITEM | ITEM DESCRIPTION | NAILS INCL. | LENGTH | QTY | WEIGHT |
|--------|------------------|-------------|--------|-----|--------|
| 402034 | LVT 907 EA | NO | 12' | 24 | 29 |
| 402035 | LVT 907 EN | NO | 12' | 24 | 29 |
| 402036 | LVT 907 BRZ | NO | 12' | 24 | 29 |

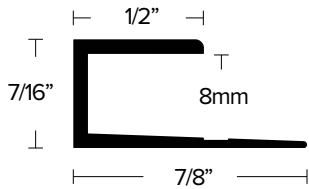

8MM SQUARE CAP EXTENDED LIP

| ITEM | ITEM DESCRIPTION | NAILS INCL. | LENGTH | QTY | WEIGHT |
|--------|------------------|-------------|--------|-----|--------|
| 402062 | LVT 908 EA | NO | 12' | 24 | 30 |
| 402063 | LVT 908 EN | NO | 12' | 24 | 30 |
| 402064 | LVT 908 BRZ | NO | 12' | 24 | 30 |

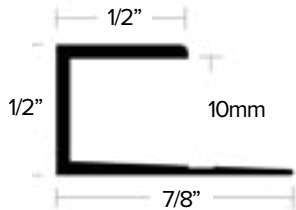

10MM SQUARE CAP

| ITEM | ITEM DESCRIPTION | NAILS INCL. | LENGTH | QTY | WEIGHT |
|--------|------------------|-------------|--------|-----|--------|
| 402232 | LVT 910 EA | NO | 12' | 24 | 34 |
| 402233 | LVT 910 EN | NO | 12' | 24 | 34 |
| 402234 | LVT 910 BRZ | NO | 12' | 24 | 34 |

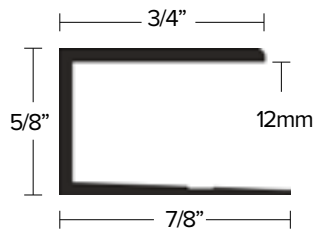

12MM SQUARE CAP EXTENDED LIP

| ITEM | ITEM DESCRIPTION | NAILS INCL. | LENGTH | QTY | WEIGHT |
|--------|------------------|-------------|--------|-----|--------|
| 402090 | LVT 912 EA | NO | 12' | 24 | 36 |
| 402091 | LVT 912 EN | NO | 12' | 24 | 36 |
| 402092 | LVT 912 BRZ | NO | 12' | 24 | 36 |



CERAMIC TILE TO LVT

- Transition from tile to lower elevation LVT flooring that is already installed.
- Lays over an uneven end of LVT flooring, reduces rework time.

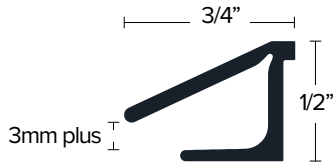

1/2" EXISTING TILE REDUCER

| ITEM | ITEM DESCRIPTION | NAILS INCL. | LENGTH | QTY | WEIGHT |
|--------|------------------|-------------|--------|-----|--------|
| 415501 | ETR 38 EA | NO | 12' | 24 | 34 |
| 415500 | ETR 38 EN | NO | 12' | 24 | 34 |
| 415502 | ETR 38 BRZ | NO | 12' | 24 | 34 |

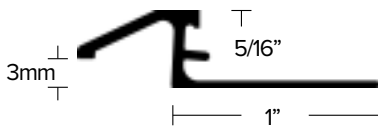

5/16" **edgetek** TILE TO 3MM LVT

| ITEM | ITEM DESCRIPTION | NAILS INCL. | LENGTH | QTY | WEIGHT |
|--------|---------------------|-------------|--------|-----|--------|
| 415372 | Edgetek TLVT 516 EA | NO | 98.5" | 12 | 15 |
| 415373 | Edgetek TLVT 516 EN | NO | 98.5" | 12 | 15 |

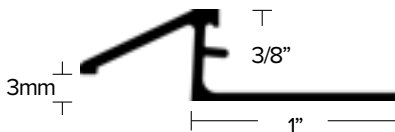

3/8" **edgetek** TILE TO 3MM LVT

| ITEM | ITEM DESCRIPTION | NAILS INCL. | LENGTH | QTY | WEIGHT |
|--------|---------------------|-------------|--------|-----|--------|
| 415380 | Edgetek TLVT 38 EA | NO | 98.5" | 12 | 15 |
| 415381 | Edgetek TLVT 38 EN | NO | 98.5" | 12 | 15 |
| 415382 | Edgetek TLVT 38 BRZ | NO | 98.5" | 12 | 15 |

LVT JOINERS

- Aluminum divider used to join LVT of same height where seam is needed.

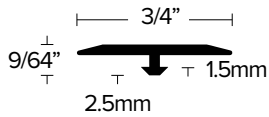

2.5MM LVT BARBED JOINER

| ITEM | ITEM DESCRIPTION | NAILS INCL. | LENGTH | QTY | WEIGHT |
|--------|------------------|-------------|--------|-----|--------|
| 402074 | LVT 102 EA | NO | 12' | 24 | 19 |
| 402075 | LVT 102 EN | NO | 12' | 24 | 19 |
| 402076 | LVT 102 BRZ | NO | 12' | 24 | 19 |

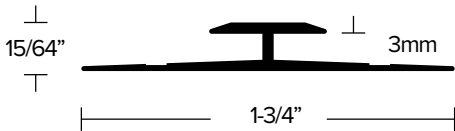

3MM LVT JOINER

| ITEM | ITEM DESCRIPTION | NAILS INCL. | LENGTH | QTY | WEIGHT |
|--------|------------------|-------------|--------|-----|--------|
| 402056 | LVT 103 EA | NO | 12' | 24 | 36 |
| 402057 | LVT 103 EN | NO | 12' | 24 | 36 |
| 402058 | LVT 103 BRZ | NO | 12' | 24 | 36 |

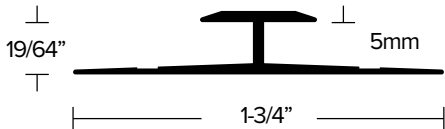

5MM LVT JOINER

| ITEM | ITEM DESCRIPTION | NAILS INCL. | LENGTH | QTY | WEIGHT |
|--------|------------------|-------------|--------|-----|--------|
| 402053 | LVT 105 EA | NO | 12' | 24 | 38 |
| 402054 | LVT 105 EN | NO | 12' | 24 | 38 |
| 402055 | LVT 105 BRZ | NO | 12' | 24 | 38 |



REDUCERS

- Transition from LVT to nothing.
- Transition from LVT to other resilient.

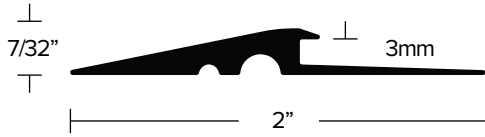

1/8" (3MM) LVT REDUCER

| ITEM | ITEM DESCRIPTION | NAILS INCL. | LENGTH | QTY | WEIGHT |
|--------|------------------|-------------|--------|-----|--------|
| 402068 | LVT 113 EA | NO | 12' | 24 | 66 |
| 402069 | LVT 113 EN | NO | 12' | 24 | 66 |
| 402070 | LVT 113 BRZ | NO | 12' | 24 | 66 |

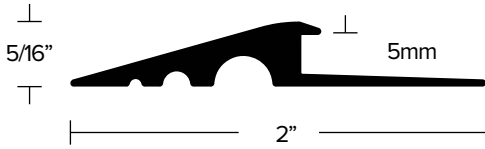

13/64" (5MM) LVT REDUCER

| ITEM | ITEM DESCRIPTION | NAILS INCL. | LENGTH | QTY | WEIGHT |
|--------|------------------|-------------|--------|-----|--------|
| 402065 | LVT 115 EA | NO | 12' | 24 | 67 |
| 402066 | LVT 115 EN | NO | 12' | 24 | 67 |
| 402067 | LVT 115 BRZ | NO | 12' | 24 | 67 |

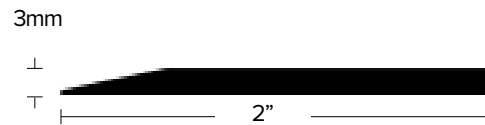

3MM LVT NO-LIP REDUCER

| ITEM | ITEM DESCRIPTION | NAILS INCL. | LENGTH | QTY | WEIGHT |
|--------|------------------|-------------|--------|-----|--------|
| 402264 | LVT 303 EA | NO | 12' | 24 | 59 |
| 402265 | LVT 303 EN | NO | 12' | 24 | 59 |
| 402274 | LVT 303 BRZ | NO | 12' | 24 | 59 |
| 402266 | VLT 303 BREA | NO | 12' | 24 | 59 |

► Drilled and countersunk, 6" centers for #3 fastener

CERAMIC FLOORING & WALL TRIMS



Trims and transitions made specifically to protect and enhance ceramic tile installations.



CREATING THE PERFECT GROUT LINE

Edgetek™ has been engineered to create a perfect grout line by extruding a feature into the product that holds the tile the perfect distance from the reveal along the length of the trim. This allows you to create a perfectly straight grout line that looks great every time. Look for the **edgetek** logo to select trim featuring the Edgetek feature.

L SHAPE TRIMS

- Provides edge on tiles that eliminates chipping and cracking of tile.
- Allows for straight edge grout line each time on Edgetek trims.

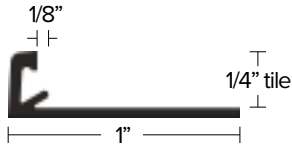

1/4" edgetek L SHAPE

| ITEM | ITEM DESCRIPTION | COMPARE TO | LENGTH | QTY | WEIGHT |
|--------|------------------|------------|--------|-----|--------|
| 415400 | Edgetek L 14 EA | AE 60 | 98.5" | 12 | 12 |
| 415401 | Edgetek L 14 EN | A 60 AT | 98.5" | 12 | 12 |

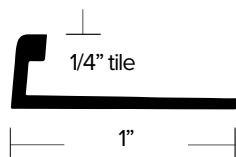

1/4" TILE TRIM

| ITEM | ITEM DESCRIPTION | COMPARE TO | LENGTH | QTY | WEIGHT |
|--------|------------------|------------|--------|-----|--------|
| 415010 | TT 14 EA | NA | 96" | 12 | 12 |
| 415097 | TT 14 EN | NA | 96" | 12 | 12 |

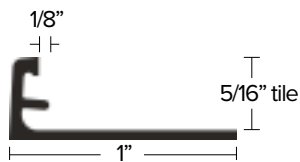

5/16" edgetek L SHAPE

| ITEM | ITEM DESCRIPTION | COMPARE TO | LENGTH | QTY | WEIGHT |
|--------|--------------------|------------|--------|-----|--------|
| 415402 | Edgetek L 516 EA | AE 80 | 98.5" | 12 | 12 |
| 415403 | Edgetek L 516 EN | A 80 AT | 98.5" | 12 | 12 |
| 415404 | Edgetek L 516 BRZ | NA | 98.5" | 12 | 12 |
| 415405 | Edgetek L 516 EBLK | A 80 AGSG | 98.5" | 12 | 12 |
| 415379 | Edgetek L 516 MF | A 80 | 98.5" | 12 | 12 |

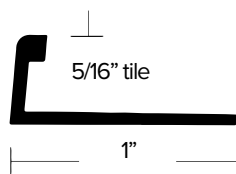

5/16" TILE TRIM

| ITEM | ITEM DESCRIPTION | COMPARE TO | LENGTH | QTY | WEIGHT |
|--------|------------------|------------|--------|-----|--------|
| 415020 | TT 516 EA | NA | 96" | 12 | 8 |
| 415032 | TT 516 EN | NA | 96" | 12 | 8 |
| 415366 | TT 516 WHITE | NA | 96" | 12 | 8 |
| 415367 | TT 516 PERGAMON | NA | 96" | 12 | 8 |
| 415368 | TT 516 GREY | NA | 96" | 12 | 8 |

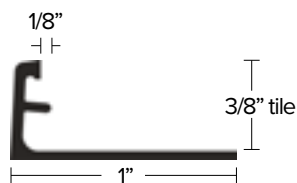

3/8" edgetek L SHAPE

| ITEM | ITEM DESCRIPTION | COMPARE TO | LENGTH | QTY | WEIGHT |
|--------|-------------------|------------|--------|-----|--------|
| 415406 | Edgetek L 38 EA | AE 100 | 98.5" | 12 | 13 |
| 415407 | Edgetek L 38 EN | A 100 AT | 98.5" | 12 | 13 |
| 415408 | Edgetek L 38 EB | A 100 AM | 98.5" | 12 | 13 |
| 415409 | Edgetek L 38 BRZ | NA | 98.5" | 12 | 13 |
| 415410 | Edgetek L 38 EBLK | A 100 AGSG | 98.5" | 12 | 13 |
| 415376 | Edgetek L 38 MF | A 100 | 98.5" | 12 | 13 |

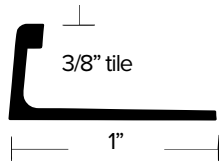

3/8" TILE TRIM

| ITEM | ITEM DESCRIPTION | COMPARE TO | LENGTH | QTY | WEIGHT |
|--------|------------------|------------|--------|-----|--------|
| 415030 | TT 38 EA | NA | 96" | 12 | 8 |
| 415038 | TT 38 EN | NA | 96" | 12 | 8 |
| 415369 | TT 38 WHITE | NA | 96" | 12 | 8 |
| 415370 | TT 38 PERGAMON | NA | 96" | 12 | 8 |
| 415371 | TT 38 GREY | NA | 96" | 12 | 8 |

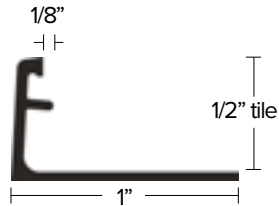

1/2" edgetek L SHAPE

| ITEM | ITEM DESCRIPTION | COMPARE TO | LENGTH | QTY | WEIGHT |
|--------|------------------|------------|--------|-----|--------|
| 415411 | Edgetek L 12 EA | AE 125 | 98.5" | 12 | 13 |
| 415412 | Edgetek L12 EN | A 125 AT | 98.5" | 12 | 13 |
| 415413 | Edgetek L 12 BRZ | NA | 98.5" | 12 | 13 |

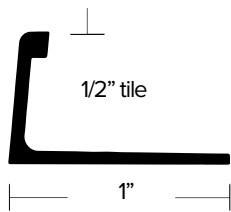

1/2" TILE TRIM

| ITEM | ITEM DESCRIPTION | COMPARE TO | LENGTH | QTY | WEIGHT |
|--------|------------------|------------|--------|-----|--------|
| 415040 | TT 12 EA | NA | 96" | 12 | 8 |
| 415099 | TT 12 EN | NA | 96" | 12 | 8 |
| 415098 | TT 12 EB | NA | 96" | 12 | 8 |
| 415045 | TT 12 BDB | NA | 96" | 12 | 8 |
| 415157 | TT 12 EBLK | NA | 96" | 12 | 8 |

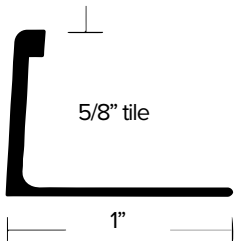

5/8" TILE TRIM

| ITEM | ITEM DESCRIPTION | COMPARE TO | LENGTH | QTY | WEIGHT |
|--------|------------------|------------|--------|-----|--------|
| 415054 | TT 58 EA | NA | 96" | 12 | 9 |
| 415378 | TT 58 EBLK | NA | 96" | 12 | 9 |



TILE QUARTER ROUND

- Edge protecting profile for outside corner walls or tiled edges.

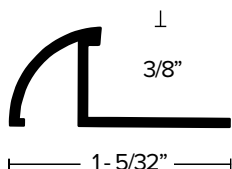

3/8" CERAMIC QUARTER ROUND

| ITEM | ITEM DESCRIPTION | COMPARE TO | LENGTH | QTY | WEIGHT |
|--------|------------------|------------|--------|-----|--------|
| 415340 | TQ 38 EA | NA | 98.5" | 12 | 12 |
| 415342 | TQ 38 EN | NA | 98.5" | 12 | 12 |

TILE REDUCERS

- Protects edges from chipping or cracking while transitioning tile to another surface or unequal height.
- Allows for straight edge grout line each time

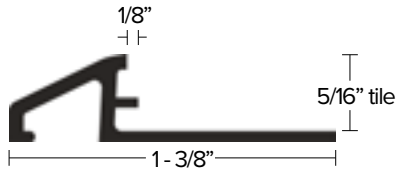

5/16" **edgetek** TILE REDUCER

| ITEM | ITEM DESCRIPTION | COMPARE TO | LENGTH | QTY | WEIGHT |
|--------|------------------|------------|--------|-----|--------|
| 415414 | Edgetek U 516 EA | AEU 80 | 98.5" | 12 | 16 |
| 415415 | Edgetek U 516 EN | AU 80 AT | 98.5" | 12 | 16 |

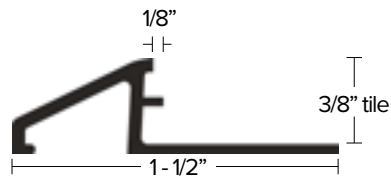

3/8" **edgetek** TILE REDUCER

| ITEM | ITEM DESCRIPTION | COMPARE TO | LENGTH | QTY | WEIGHT |
|--------|------------------|------------|--------|-----|--------|
| 415416 | Edgetek U 38 EA | AEU 100 | 98.5" | 12 | 18 |
| 415417 | Edgetek U 38 EN | AU 100 AT | 98.5" | 12 | 18 |
| 415418 | Edgetek U 38 BRZ | NA | 98.5" | 12 | 18 |

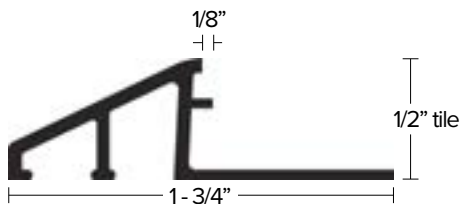

1/2" **edgetek** TILE REDUCER

| ITEM | ITEM DESCRIPTION | COMPARE TO | LENGTH | QTY | WEIGHT |
|--------|------------------|------------|--------|-----|--------|
| 415419 | Edgetek U 12 EA | AEU 125 | 98.5" | 12 | 21 |
| 415420 | Edgetek U 12 EN | AU 125 AT | 98.5" | 12 | 21 |



TILE TO LVT

- Transition from tile to lower elevation LVT flooring that is already installed.
- Lays over an uneven end of LVT flooring, reduces rework time.

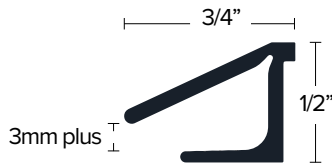

1/2" EXISTING TILE REDUCER

| ITEM | ITEM DESCRIPTION | COMPARE TO | LENGTH | QTY | WEIGHT |
|--------|------------------|------------|--------|-----|--------|
| 415501 | ETR 38 EA | NA | 12' | 24 | 34 |
| 415500 | ETR 38 EN | NA | 12' | 24 | 34 |
| 415502 | ETR 38 BRZ | NA | 12' | 24 | 34 |

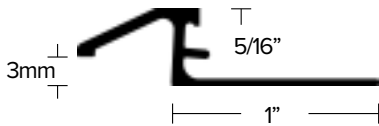

5/16" **edgetek** TILE TO 3MM LVT

| ITEM | ITEM DESCRIPTION | COMPARE TO | LENGTH | QTY | WEIGHT |
|--------|---------------------|------------|--------|-----|--------|
| 415372 | Edgetek TLVT 516 EA | NA | 98.5" | 12 | 15 |
| 415373 | Edgetek TLVT 516 EN | NA | 98.5" | 12 | 15 |

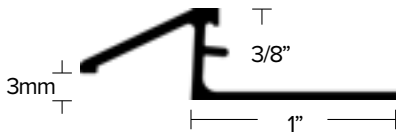

3/8" **edgetek** TILE TO 3MM LVT

| ITEM | ITEM DESCRIPTION | COMPARE TO | LENGTH | QTY | WEIGHT |
|--------|---------------------|------------|--------|-----|--------|
| 415380 | Edgetek TLVT 38 EA | NO | 98.5" | 12 | 15 |
| 415381 | Edgetek TLVT 38 EN | NO | 98.5" | 12 | 15 |
| 415382 | Edgetek TLVT 38 BRZ | NO | 98.5" | 12 | 15 |

CARPET TUCK

- Transitions from tile to carpet

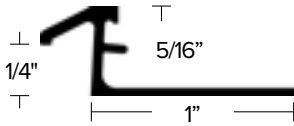

5/16" edgetek CARPET TUCK

| ITEM | ITEM DESCRIPTION | COMPARE TO | LENGTH | QTY | WEIGHT |
|--------|-------------------|------------|--------|-----|--------|
| 415374 | Edgetek CT 516 EA | AETK 80 | 98.5" | 12 | 12 |

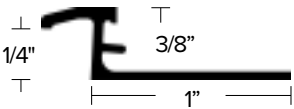

3/8" edgetek CARPET TUCK

| ITEM | ITEM DESCRIPTION | COMPARE TO | LENGTH | QTY | WEIGHT |
|--------|-------------------|------------|--------|-----|--------|
| 415383 | Edgetek CT 38 EA | AETK 100 | 98.5" | 12 | 13 |
| 415384 | Edgetek CT 38 EN | ATK 100 AT | 98.5" | 12 | 13 |
| 415385 | Edgetek CT 38 BRZ | NA | 98.5" | 12 | 13 |



ROUND BULL NOSE

- Edge protecting profile for outside corners of tiled surfaces.
- Allows for coordination of finishes within a given area.

5/16" **edgetek** TILE BULL NOSE

| ITEM | ITEM DESCRIPTION | COMPARE TO | LENGTH | QTY | WEIGHT |
|--------|--------------------|------------|--------|-----|--------|
| 415421 | Edgetek R 516 EA | RO 80 AE | 98.5" | 12 | 13 |
| 415422 | Edgetek R 516 EN | RO 80 AT | 98.5" | 12 | 13 |
| 415423 | Edgetek R 516 BBDA | RO 80 ACG | 98.5" | 12 | 13 |
| 415424 | Edgetek R 516 BRZ | NA | 98.5" | 12 | 13 |

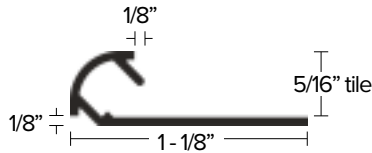

3/8" **edgetek** TILE BULL NOSE

| ITEM | ITEM DESCRIPTION | COMPARE TO | LENGTH | QTY | WEIGHT |
|--------|-------------------|------------|--------|-----|--------|
| 415425 | Edgetek R 38 EA | RO 100 AE | 98.5" | 12 | 14 |
| 415426 | Edgetek R 38 EN | RO 100 AT | 98.5" | 12 | 14 |
| 415427 | Edgetek R 38 BBDA | RO 100 ACG | 98.5" | 12 | 14 |
| 415428 | Edgetek R 38 BRZ | NA | 98.5" | 12 | 14 |

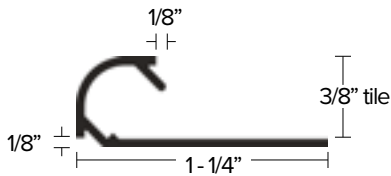

SQUARE CORNER

- Edge protecting profile for outside corner walls of tiled edges.
- Allows for straight edge grout line.

5/16" **edgetek** SQUARE CORNER

| ITEM | ITEM DESCRIPTION | COMPARE TO | LENGTH | QTY | WEIGHT |
|--------|--------------------|------------|--------|-----|--------|
| 415431 | Edgetek Q 516 EA | Q 80 AE | 98.5" | 12 | 15 |
| 415432 | Edgetek Q 516 EN | Q 80 AT | 98.5" | 12 | 15 |
| 415433 | Edgetek Q 516 BBDA | Q 80 ACG | 98.5" | 12 | 15 |
| 415434 | Edgetek Q 516 BRZ | NA | 98.5" | 12 | 15 |

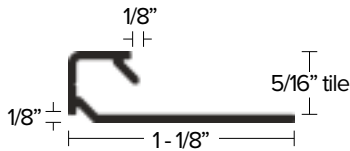

3/8" **edgetek** SQUARE CORNER

| ITEM | ITEM DESCRIPTION | COMPARE TO | LENGTH | QTY | WEIGHT |
|--------|-------------------|------------|--------|-----|--------|
| 415435 | Edgetek Q 38 EA | Q 100 AE | 98.5" | 12 | 15 |
| 415436 | Edgetek Q 38 EN | Q 100 AT | 98.5" | 12 | 15 |
| 415437 | Edgetek Q 38 BBDA | Q 100 ACG | 98.5" | 12 | 15 |
| 415438 | Edgetek Q 38 BRZ | NA | 98.5" | 12 | 15 |

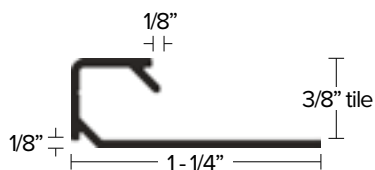

METAL CORNERS

- Aluminum corners for use with ceramic trims.
- Eliminates the need for a mitered edge
- Compatible with Edgetek R and Q profiles



5/16" R CORNER

| ITEM | ITEM DESCRIPTION | COMPARE TO | FOR USE WITH | QTY |
|--------|------------------|------------|--------------------------|-----|
| 415700 | R Corner 516 EA | RO 80 AE | edgetek R 516 EA | 2 |
| 415704 | R Corner 516 EN | RO 80 AT | edgetek R 516 EN | 2 |
| 415708 | R Corner 516 BRZ | NA | edgetek R 516 BRZ | 2 |



3/8" R CORNER

| ITEM | ITEM DESCRIPTION | COMPARE TO | FOR USE WITH | QTY |
|--------|------------------|------------|-------------------------|-----|
| 415702 | R Corner 38 EA | RO 100 AE | edgetek R 38 EA | 2 |
| 415706 | R Corner 38 EN | RO 100 AT | edgetek R 38 EN | 2 |
| 415710 | R Corner 38 BRZ | NA | edgetek R 38 BRZ | 2 |



5/16" Q CORNER

| ITEM | ITEM DESCRIPTION | COMPARE TO | FOR USE WITH | QTY |
|--------|------------------|------------|--------------------------|-----|
| 415701 | Q Corner 516 EA | Q 80 AE | edgetek Q 516 EA | 2 |
| 415705 | Q Corner 516 EN | Q 80 AT | edgetek Q 516 EN | 2 |
| 415709 | Q Corner 516 BRZ | NA | edgetek Q 516 BRZ | 2 |



3/8" Q CORNER

| ITEM | ITEM DESCRIPTION | COMPARE TO | FOR USE WITH | QTY |
|--------|------------------|------------|-------------------------|-----|
| 415703 | Q Corner 38 EA | Q 100 AE | edgetek Q 38 EA | 2 |
| 415707 | Q Corner 38 EN | Q 100 AT | edgetek Q 38 EN | 2 |
| 415711 | Q Corner 38 BRZ | NA | edgetek Q 38 BRZ | 2 |



STAIR NOSING

- Basic nosing for steps.
- Provides finished edge on steps or counter tops.

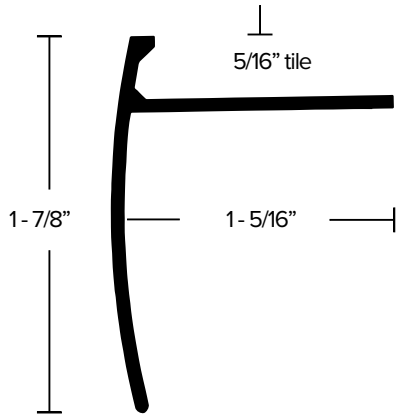

| 5/16" STAIR NOSING | | | | | |
|--------------------|------------------|------------|--------|-----|--------|
| ITEM | ITEM DESCRIPTION | COMPARE TO | LENGTH | QTY | WEIGHT |
| 415333 | TS 516 EN | NA | 98.5" | 12 | 23 |

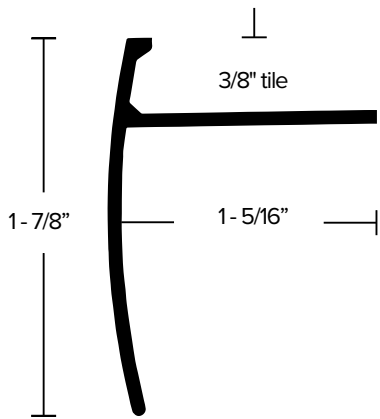

| 3/8" STAIR NOSING | | | | | |
|-------------------|------------------|------------|--------|-----|--------|
| ITEM | ITEM DESCRIPTION | COMPARE TO | LENGTH | QTY | WEIGHT |
| 415350 | TS 38 EA | NA | 98.5" | 12 | 25 |
| 415334 | TS 38 EN | NA | 98.5" | 12 | 25 |

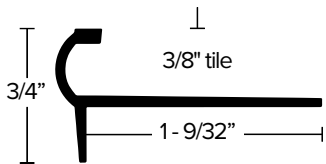

| 3/8" STAIR NOSING | | | | | |
|-------------------|------------------|------------|--------|-----|--------|
| ITEM | ITEM DESCRIPTION | COMPARE TO | LENGTH | QTY | WEIGHT |
| 415346 | SE 38 EA | NA | 98.5" | 12 | 15 |
| 415344 | SE 38 EN | NA | 98.5" | 12 | 15 |

STEP NOSING

- Profile primarily used on stair edges or counter tops.
- Allows for straight edge grout line.

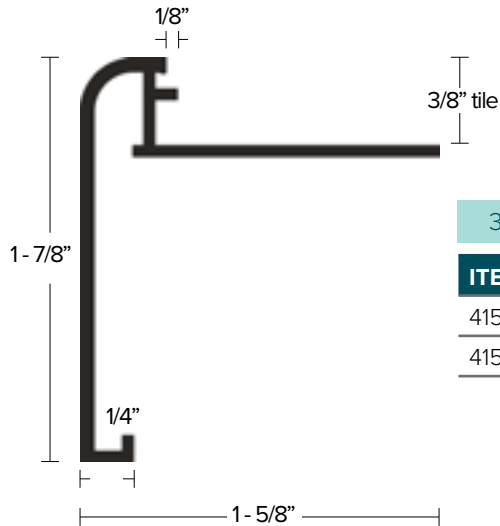

3/8" edgetek[®] STEP

| ITEM | ITEM DESCRIPTION | COMPARE TO | LENGTH | QTY | WEIGHT |
|--------|---------------------|--------------|--------|-----|--------|
| 415429 | Edgetek Step 38 EA | RS 100 AE 39 | 98.5" | 12 | 29 |
| 415430 | Edgetek Step 38 BRZ | NA | 98.5" | 12 | 29 |

T-SEAM BINDER

- Transitions between 2 ceramic pieces of equal height.
- Prevents tile from chipping and cracking.

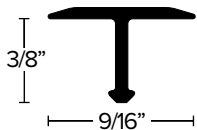

9/16" T-SEAM BINDER

| ITEM | ITEM DESCRIPTION | COMPARE TO | LENGTH | QTY | WEIGHT |
|--------|------------------|------------|--------|-----|--------|
| 415265 | T 916 EA | NA | 98.5" | 12 | 12 |

VINYL TRIMS



Reducers, joiners, cove, stair nosing and snap-in dividers. A durable, flexible product with a tough matte finish.

COVE STICK

- Used to support sheet vinyl coving
- Made from PVC
- Helps protect flooring from puncture



1 - 1/4" COVE STICK

| ITEM | ITEM DESCRIPTION | LENGTH | QTY | WEIGHT |
|--------|------------------|--------|-----|--------|
| 460170 | VT 051 PVC | 5' | 120 | 37 |

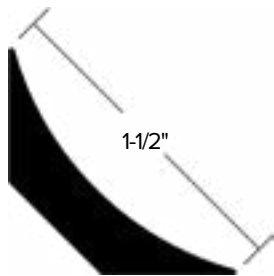

1 - 1/2" COVE STICK

| ITEM | ITEM DESCRIPTION | LENGTH | QTY | WEIGHT |
|--------|------------------|--------|-----|--------|
| 460175 | VT 052 PVC | 5' | 80 | 27 |

REDUCERS

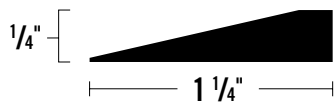

REDUCER FOR GLUE-DOWN CARPET

| ITEM | ITEM DESCRIPTION | LENGTH | QTY | WEIGHT |
|--------|------------------|--------|-----|--------|
| 460203 | VT 320 BEIGE | 12' | 20 | 24 |

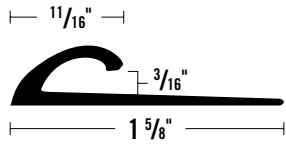

CARPET COVING CAP

| ITEM | ITEM DESCRIPTION | LENGTH | QTY | WEIGHT |
|--------|------------------|--------|-----|--------|
| 460103 | VT 410 BEIGE | 12' | 20 | 22 |

► Flexible carpet cove cap

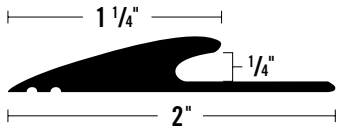

REDUCER FOR GLUE-DOWN CARPET

| ITEM | ITEM DESCRIPTION | LENGTH | QTY | WEIGHT |
|--------|------------------|--------|-----|--------|
| 460320 | VT 332 BLACK | 12' | 20 | 31 |
| 460321 | VT 332 BROWN | 12' | 20 | 31 |
| 460322 | VT 332 CHARCOAL | 12' | 20 | 31 |
| 460323 | VT 332 BEIGE | 12' | 20 | 31 |

► For 1/4" carpet

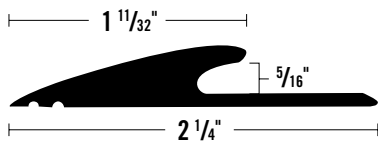

REDUCER FOR GLUE-DOWN CARPET

| ITEM | ITEM DESCRIPTION | LENGTH | QTY | WEIGHT |
|--------|------------------|--------|-----|--------|
| 460310 | VT 331 BLACK | 12' | 20 | 42 |
| 460311 | VT 331 BROWN | 12' | 20 | 42 |
| 460312 | VT 331 CHARCOAL | 12' | 20 | 42 |

► For 5/16" carpet

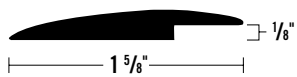

OVER THE TOP RESILIENT REDUCER

| ITEM | ITEM DESCRIPTION | LENGTH | QTY | WEIGHT |
|--------|------------------|--------|-----|--------|
| 460260 | VT 326 BLACK | 12' | 20 | 28 |
| 460263 | VT 326 CHARCOAL | 12' | 20 | 28 |
| 460262 | VT 326 BEIGE | 12' | 20 | 28 |



TILE REDUCER FOR RESILIENT FLOORS

| ITEM | ITEM DESCRIPTION | LENGTH | QTY | WEIGHT |
|--------|------------------|--------|-----|--------|
| 460240 | VT 324 BLACK | 3' | 50 | 8 |
| 460241 | VT 324 BROWN | 3' | 50 | 8 |
| 460242 | VT 324 CHARCOAL | 3' | 50 | 8 |
| 460243 | VT 324 BEIGE | 3' | 50 | 8 |



TILE REDUCER FOR RESILIENT FLOORS

| ITEM | ITEM DESCRIPTION | LENGTH | QTY | WEIGHT |
|--------|------------------|--------|-----|--------|
| 460250 | VT 325 BLACK | 3' | 50 | 17 |
| 460251 | VT 325 BROWN | 3' | 50 | 17 |
| 460252 | VT 325 CHARCOAL | 3' | 50 | 17 |
| 460253 | VT 325 BEIGE | 3' | 50 | 17 |

► With beveled edge for resilient floors

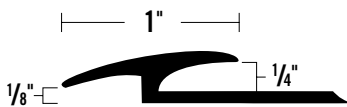

TILE AND CARPET JOINER

| ITEM | ITEM DESCRIPTION | LENGTH | QTY | WEIGHT |
|--------|------------------|--------|-----|--------|
| 460540 | VT 754 BLACK | 12' | 20 | 28 |
| 460541 | VT 754 BROWN | 12' | 20 | 28 |
| 460542 | VT 754 CHARCOAL | 12' | 20 | 28 |
| 460543 | VT 754 BEIGE | 12' | 20 | 28 |

► For 1/4" tile or carpet

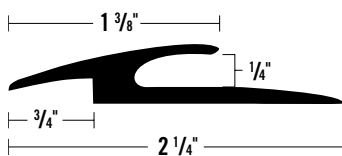

TILE AND CARPET JOINER

| ITEM | ITEM DESCRIPTION | LENGTH | QTY | WEIGHT |
|--------|------------------|--------|-----|--------|
| 460550 | VT 756 BLACK | 12' | 20 | 26 |
| 460551 | VT 756 BROWN | 12' | 20 | 26 |
| 460552 | VT 756 CHARCOAL | 12' | 20 | 26 |
| 460553 | VT 756 BEIGE | 12' | 20 | 26 |

► For 1/4" tile or carpet

STAIR NOSINGS

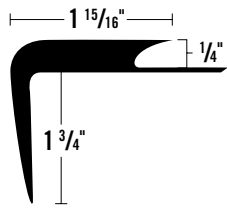

STAIR NOSING

| ITEM | ITEM DESCRIPTION | LENGTH | QTY | WEIGHT |
|--------|------------------|--------|-----|--------|
| 460400 | VT 640 BLACK | 12' | 6 | 43 |
| 460401 | VT 640 BROWN | 12' | 6 | 43 |

► Heavy duty stair nosing

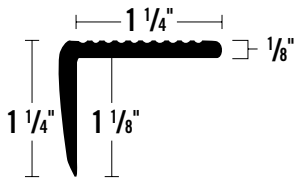

STAIR NOSING

| ITEM | ITEM DESCRIPTION | LENGTH | QTY | WEIGHT |
|--------|------------------|--------|-----|--------|
| 460420 | VT 642 BLACK | 12' | 12 | 23 |
| 460421 | VT 642 BROWN | 12' | 12 | 23 |
| 460422 | VT 642 CHARCOAL | 12' | 12 | 23 |
| 460423 | VT 642 BEIGE | 12' | 12 | 23 |

► Square top nosing

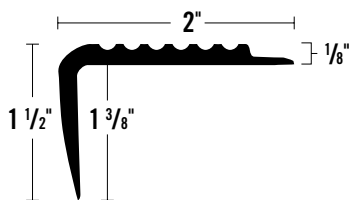

STAIR NOSING

| ITEM | ITEM DESCRIPTION | LENGTH | QTY | WEIGHT |
|--------|------------------|--------|-----|--------|
| 460410 | VT 641 BLACK | 12' | 12 | 42 |
| 460411 | VT 641 BROWN | 12' | 12 | 42 |
| 460412 | VT 641 CHARCOAL | 12' | 12 | 42 |

► Commercial stair nosing

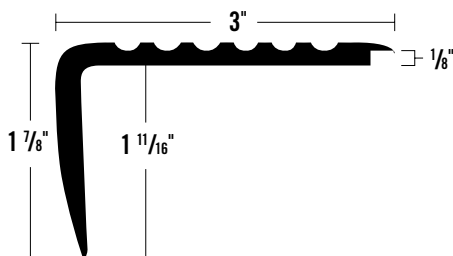

STAIR NOSING

| ITEM | ITEM DESCRIPTION | LENGTH | QTY | WEIGHT |
|--------|------------------|--------|-----|--------|
| 460440 | VT 644 BLACK | 12' | 12 | 78 |
| 460441 | VT 644 BROWN | 12' | 12 | 78 |
| 460444 | VT 644 BEIGE | 12' | 12 | 78 |

► Overlap nosing for tile and resilient

SNAP-IN DIVIDERS

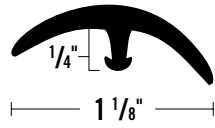

SNAP-IN DIVIDERS AND EDGES

| ITEM | ITEM DESCRIPTION | LENGTH | QTY | WEIGHT |
|--------|------------------|--------|-----|--------|
| 460040 | VT 704 BLACK | 12' | 20 | 21 |
| 460041 | VT 704 BROWN | 12' | 20 | 21 |
| 460042 | VT 704 CHARCOAL | 12' | 20 | 21 |
| 460044 | VT 704 BEIGE | 12' | 20 | 21 |

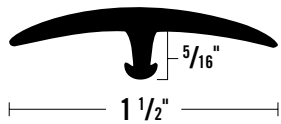

SNAP-IN DIVIDERS AND EDGES

| ITEM | ITEM DESCRIPTION | LENGTH | QTY | WEIGHT |
|--------|------------------|--------|-----|--------|
| 460030 | VT 703 BLACK | 12' | 20 | 27 |
| 460031 | VT 703 BROWN | 12' | 20 | 27 |
| 460032 | VT 703 CHARCOAL | 12' | 20 | 27 |
| 460034 | VT 703 BEIGE | 12' | 20 | 27 |

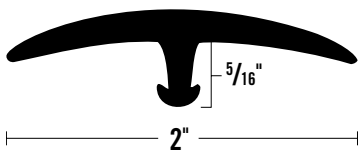

SNAP-IN DIVIDERS AND EDGES

| ITEM | ITEM DESCRIPTION | LENGTH | QTY | WEIGHT |
|--------|------------------|--------|-----|--------|
| 460060 | VT 706 BEIGE | 12' | 20 | 29 |

FUTURA TRANSITIONS TROWELS



- Over 30 notch types available for use with carpet, ceramic, wood, vinyl and other resilients.
- Balanced for professional use.
- Hardened and tempered steel blade.

TROWEL SPECS

FUTURA TRANSITIONS TROWELS

| ITEM | ITEM DESCRIPTION | |
|------------------------|--|----|
| Premium Trowels | | |
| 020044 | FUT TROWEL 4.5x11" 1/16x1/32x5/64 U* | 6 |
| 020045 | FUT TROWEL 4.5x11" 1/4x1/8x1/4 SQ* | 6 |
| 020046 | FUT TROWEL 4.5x11" 3/16x1/4x1/2 V* | 6 |
| 020047 | FUT TROWEL 4.5x14" 1/16x1/32x1/32 U* | 6 |
| 020048 | FUT TROWEL 4.5x14" 1/16x1/16x1/16 SQ* | 6 |
| 020049 | FUT TROWEL 4.5x14" 1/8x1/8x1/16 V* | 6 |
| 020050 | FUT TROWEL 4x16" Pool Finishing* | 6 |
| 020051 | FUT TROWEL 4.5x11" 1/16x1/32x1/32 U* | 6 |
| 020052 | FUT TROWEL 4.5x11" 1/16x1/16x3/32 U* | 8 |
| 020053 | FUT TROWEL 4.5x11" 1/8x1/8x1/16 U* | 6 |
| 020055 | FUT TROWEL 4.5x11" 1/8x1/8x1/8 U* | 6 |
| 020056 | FUT TROWEL 4.5x11" 1/16x1/16x1/16 SQ* | 6 |
| 020057 | FUT TROWEL 4.5x11" 1/8x1/8x1/8 SQ* | 6 |
| 020058 | FUT TROWEL 4.5x11" 3/16x3/16x3/16 SQ* | 6 |
| 020059 | FUT TROWEL 4.5x11" 3/16x5/32 V* | 6 |
| 020060 | FUT TROWEL 4.5x11" 3/32x3/32x3/32 V* | 6 |
| 020061 | FUT TROWEL 4.5x11" 1/8x1/8x1/16 V* | 6 |
| 020062 | FUT TROWEL 4x14" Flat Finishing | 6 |
| 020097 | FUT TROWEL LH 4.5x11" 1/16x1/32x1/32 U* | 6 |
| 020098 | FUT TROWEL LH 4-5x11" 1/16x1/16x1/16 SQ* | 6 |
| 020099 | FUT TROWEL LH 4.5x11" 1/8x1/8x1/16 V* | 6 |
| 020100 | FUT TROWEL 4.5x11" 1/16x1/16x1/16 V* | 6 |
| 030000 | FUT TROWEL 4.5x11" 3/16x1/4x5/16 V* | 6 |
| 049038 | FUT TROWEL 4.5x11" 1/2x1/2x1/2 SQ* | 6 |
| 049110 | FUT TROWEL 4.5x11" 1/4x1/4x1/4 SQ* | 6 |
| 049112 | FUT TROWEL 4.5x11" 1/4x3/8x1/4 SQ* | 6 |
| 049116 | FUT TROWEL 4.5x11" 1/4x3/16 V* | 6 |
| 049972 | FUT TROWEL 4.5x11" 1/4x1/4 V* | 6 |
| Economy Trowels | | |
| 020063 | FUT ECONO TRWL 4x9" 1/16x1/32x1/32 U* | 12 |
| 020064 | FUT ECONO TRWL 4x9" 1/16x1/16x1/16 SQ* | 12 |
| 049100 | FUT ECONO TRWL 4x9" 1/4x1/4x1/4 SQ* | 12 |
| 049102 | FUT ECONO TRWL 4x9" 1/4x3/8x1/4 SQ* | 12 |
| 049104 | FUT ECONO TRWL 4x9" 1/2x1/2x1/2 *SQ | 12 |
| 049108 | FUT ECONO TRWL 4x9" 3/16x5/32 V* | 12 |



PREMIUM TROWELS

- Premium ergonomic handle.
- Rubberized grip for greater control.

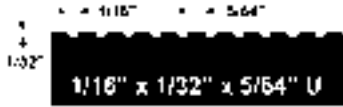

| ITEM | NOTCH DESCRIPTION | NOTCH STYLE | BLADE SIZE | BLADE ANGLE | CASE QTY |
|--------|-----------------------|-------------|------------|-------------|----------|
| 020044 | 1/16" x 1/32" x 5/64" | U NOTCH | 4-1/2 x 11 | 15° | 6 |

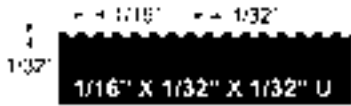

| ITEM | NOTCH DESCRIPTION | NOTCH STYLE | BLADE SIZE | BLADE ANGLE | CASE QTY |
|--------|--------------------------------------|-------------|------------|-------------|----------|
| 020051 | 1/16" x 1/32" x 1/32" | U NOTCH | 4-1/2 x 11 | 15° | 6 |
| 020097 | 1/16" x 1/32" x 1/32" LEFT HANDED | U NOTCH | 4-1/2 x 11 | 15° | 6 |
| 020047 | 1/16" x 1/32" x 1/32" | U NOTCH | 4-1/2 x 14 | 15° | 6 |

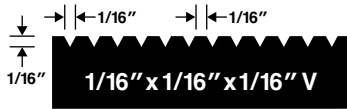

| ITEM | NOTCH DESCRIPTION | NOTCH STYLE | BLADE SIZE | BLADE ANGLE | CASE QTY |
|--------|-----------------------|--------------|------------|-------------|----------|
| 020100 | 1/16" x 1/16" x 1/16" | FLAT V NOTCH | 4-1/2 x 11 | 15° | 6 |

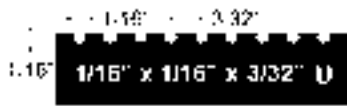

| ITEM | NOTCH DESCRIPTION | NOTCH STYLE | BLADE SIZE | BLADE ANGLE | CASE QTY |
|--------|-----------------------|-------------|------------|-------------|----------|
| 020052 | 1/16" x 1/16" x 3/32" | U NOTCH | 4-1/2 x 11 | 15° | 6 |



| ITEM | NOTCH DESCRIPTION | NOTCH STYLE | BLADE SIZE | BLADE ANGLE | CASE QTY |
|--------|---------------------|-------------|------------|-------------|----------|
| 020053 | 1/8" x 1/8" x 1/16" | U NOTCH | 4-1/2 x 11 | 15° | 6 |



| ITEM | NOTCH DESCRIPTION | NOTCH STYLE | BLADE SIZE | BLADE ANGLE | CASE QTY |
|--------|--------------------|-------------|------------|-------------|----------|
| 020055 | 1/8" x 1/8" x 1/8" | U NOTCH | 4-1/2 x 11 | 15° | 6 |



| ITEM | NOTCH DESCRIPTION | NOTCH STYLE | BLADE SIZE | BLADE ANGLE | CASE QTY |
|--------|-----------------------------------|--------------|------------|-------------|----------|
| 020056 | 1/16" x 1/16" x 1/16" | SQUARE NOTCH | 4-1/2 x 11 | 15° | 6 |
| 020098 | 1/16" x 1/16" x 1/16" LEFT HANDED | SQUARE NOTCH | 4-1/2 x 11 | 15° | 6 |
| 020048 | 1/16" x 1/16" x 1/16" | SQUARE NOTCH | 4-1/2 x 14 | 15° | 6 |

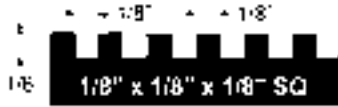

| ITEM | NOTCH DESCRIPTION | NOTCH STYLE | BLADE SIZE | BLADE ANGLE | CASE QTY |
|--------|--------------------|--------------|------------|-------------|----------|
| 020057 | 1/8" x 1/8" x 1/8" | SQUARE NOTCH | 4-1/2 x 11 | SQUARE | 6 |



| ITEM | NOTCH DESCRIPTION | NOTCH STYLE | BLADE SIZE | BLADE ANGLE | CASE QTY |
|--------|-----------------------|--------------|------------|-------------|----------|
| 020058 | 3/16" x 3/16" x 3/16" | SQUARE NOTCH | 4-1/2 x 11 | SQUARE | 6 |



| ITEM | NOTCH DESCRIPTION | NOTCH STYLE | BLADE SIZE | BLADE ANGLE | CASE QTY |
|--------|--------------------|--------------|------------|-------------|----------|
| 020045 | 1/4" x 1/8" x 1/4" | SQUARE NOTCH | 4-1/2 x 11 | SQUARE | 6 |

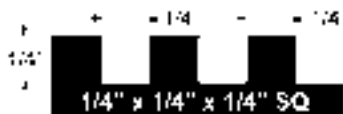

| ITEM | NOTCH DESCRIPTION | NOTCH STYLE | BLADE SIZE | BLADE ANGLE | CASE QTY |
|--------|--------------------|--------------|------------|-------------|----------|
| 049110 | 1/4" x 1/4" x 1/4" | SQUARE NOTCH | 4-1/2 x 11 | SQUARE | 6 |

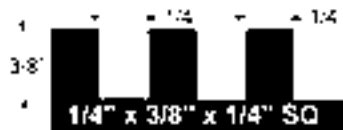

| ITEM | NOTCH DESCRIPTION | NOTCH STYLE | BLADE SIZE | BLADE ANGLE | CASE QTY |
|--------|--------------------|--------------|------------|-------------|----------|
| 049112 | 1/4" x 3/8" x 1/4" | SQUARE NOTCH | 4-1/2 x 11 | SQUARE | 6 |



| ITEM | NOTCH DESCRIPTION | NOTCH STYLE | BLADE SIZE | BLADE ANGLE | CASE QTY |
|--------|--------------------|--------------|------------|-------------|----------|
| 049038 | 1/2" x 1/2" x 1/2" | SQUARE NOTCH | 4-1/2 x 11 | SQUARE | 6 |



| ITEM | NOTCH DESCRIPTION | NOTCH STYLE | BLADE SIZE | BLADE ANGLE | CASE QTY |
|--------|-------------------|-------------|------------|-------------|----------|
| 020059 | 3/16" x 5/32" | V NOTCH | 4-1/2 x 11 | SQUARE | 6 |

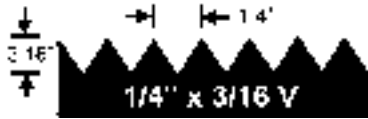

| ITEM | NOTCH DESCRIPTION | NOTCH STYLE | BLADE SIZE | BLADE ANGLE | CASE QTY |
|--------|-------------------|-------------|------------|-------------|----------|
| 049116 | 1/4" x 3/16" | V NOTCH | 4-1/2 x 11 | SQUARE | 6 |



| ITEM | NOTCH DESCRIPTION | NOTCH STYLE | BLADE SIZE | BLADE ANGLE | CASE QTY |
|--------|-------------------|-------------|------------|-------------|----------|
| 049972 | 1/4" x 1/4" | V NOTCH | 4-1/2 x 11 | SQUARE | 6 |

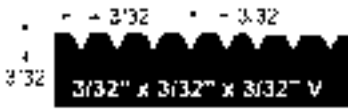

| ITEM | NOTCH DESCRIPTION | NOTCH STYLE | BLADE SIZE | BLADE ANGLE | CASE QTY |
|--------|-----------------------|--------------|------------|-------------|----------|
| 020060 | 3/32" x 3/32" x 3/32" | FLAT V NOTCH | 4-1/2 x 11 | 15° | 6 |

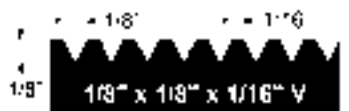

| ITEM | NOTCH DESCRIPTION | NOTCH STYLE | BLADE SIZE | BLADE ANGLE | CASE QTY |
|--------|------------------------------------|--------------|------------|-------------|----------|
| 020061 | 1/8" x 1/8" x 1/16" | FLAT V NOTCH | 4-1/2 x 11 | 15° | 6 |
| 020099 | 1/8" x 1/8" x 1/16" LEFT HANDED | FLAT V NOTCH | 4-1/2 x 11 | 15° | 6 |
| 020049 | 1/8" x 1/8" x 1/16" | FLAT V NOTCH | 4-1/2 x 14 | 15° | 6 |



| ITEM | NOTCH DESCRIPTION | NOTCH STYLE | BLADE SIZE | BLADE ANGLE | CASE QTY |
|--------|----------------------|--------------|------------|-------------|----------|
| 030000 | 3/16" x 1/4" x 5/16" | FLAT V NOTCH | 4-1/2 x 11 | SQUARE | 6 |



| ITEM | NOTCH DESCRIPTION | NOTCH STYLE | BLADE SIZE | BLADE ANGLE | CASE QTY |
|--------|---------------------|--------------|------------|-------------|----------|
| 020046 | 3/16" x 1/4" x 1/2" | FLAT V NOTCH | 4-1/2 x 11 | SQUARE | 6 |



| ITEM | NOTCH DESCRIPTION | NOTCH STYLE | BLADE SIZE | BLADE ANGLE | CASE QTY |
|--------|-------------------|----------------|------------|-------------|----------|
| 020062 | FLAT SMOOTHING | FLAT SMOOTHING | 4 x 14 | SQUARE | 6 |

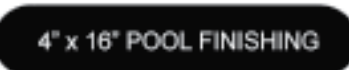

| ITEM | NOTCH DESCRIPTION | NOTCH STYLE | BLADE SIZE | BLADE ANGLE | CASE QTY |
|--------|-------------------|---------------------|------------|-------------|----------|
| 020050 | FLAT POOL | FLAT POOL SMOOTHING | 4 x 16 | ROUND | 6 |

ECONOMY TROWELS

- Durable plastic handle.
- Lower cost

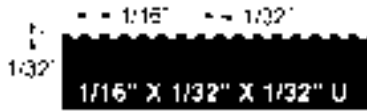

| ITEM | NOTCH DESCRIPTION | NOTCH STYLE | BLADE SIZE | BLADE ANGLE | CASE QTY |
|--------|-----------------------|-------------|------------|-------------|----------|
| 020063 | 1/16" x 1/32" x 1/32" | U NOTCH | 4 x 9 | SQUARE | 12 |



| ITEM | NOTCH DESCRIPTION | NOTCH STYLE | BLADE SIZE | BLADE ANGLE | CASE QTY |
|--------|-----------------------|--------------|------------|-------------|----------|
| 020064 | 1/16" x 1/16" x 1/16" | SQUARE NOTCH | 4 x 9 | SQUARE | 12 |

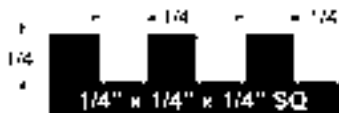

| ITEM | NOTCH DESCRIPTION | NOTCH STYLE | BLADE SIZE | BLADE ANGLE | CASE QTY |
|--------|--------------------|--------------|------------|-------------|----------|
| 049100 | 1/4" x 1/4" x 1/4" | SQUARE NOTCH | 4 x 9 | SQUARE | 12 |

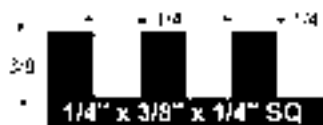

| ITEM | NOTCH DESCRIPTION | NOTCH STYLE | BLADE SIZE | BLADE ANGLE | CASE QTY |
|--------|--------------------|--------------|------------|-------------|----------|
| 049102 | 1/4" x 3/8" x 1/4" | SQUARE NOTCH | 4 x 9 | SQUARE | 12 |



| ITEM | NOTCH DESCRIPTION | NOTCH STYLE | BLADE SIZE | BLADE ANGLE | CASE QTY |
|--------|--------------------|--------------|------------|-------------|----------|
| 049104 | 1/2" x 1/2" x 1/2" | SQUARE NOTCH | 4 x 9 | SQUARE | 12 |



| ITEM | NOTCH DESCRIPTION | NOTCH STYLE | BLADE SIZE | BLADE ANGLE | CASE QTY |
|--------|-------------------|-------------|------------|-------------|----------|
| 049108 | 3/16" x 5/32" | V NOTCH | 4 x 9 | SQUARE | 12 |

RUBBER BACKED CARPET

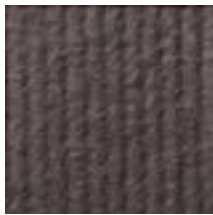

Smooth Back



020060

120-140 Sq. Ft./Gal. (13-16 Sq. Yd.)

Rough Back



020061

90-110 Sq. Ft./Gal. (10-12 Sq. Yd.)

HOT MELT BACKED CARPET

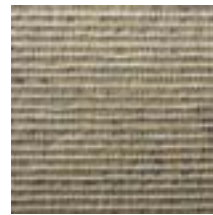

020061

OR



020055

90-110 Sq. Ft./Gal. (10-12 Sq. Yd.)

SYNTHETIC WOVEN BACKED CARPET



020061

90-110 Sq. Ft./Gal. (10-12 Sq. Yd.)

OR



020055

90-110 Sq. Ft./Gal. (10-12 Sq. Yd.)

Action-Bac™

CUSHION BACKED CARPET



020060

120-140 Sq. Ft./Gal. (13-16 Sq. Yd.)

Enhancer Plus™

NON-WOVEN POLYPROPYLENE & NEEDLE-PUNCHED CARPET

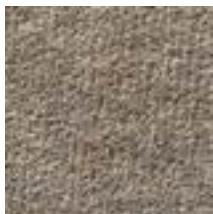

Smooth Back



020060

120-140 Sq. Ft./Gal. (13-16 Sq. Yd.)

Rough Back



020061

90-110 Sq. Ft./Gal. (10-12 Sq. Yd.)

MODULAR CARPET TILE

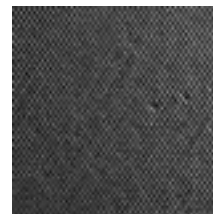

020056

140-170 Sq. Ft./Gal. (15-19 Sq. Yd.)

LATEX UNITARY BACKED CARPET



Smooth Back



020061

90-110 Sq. Ft./Gal. (10-12 Sq. Yd.)

Rough Back



020053

55-65 Sq. Ft./Gal. (6-7 Sq. Yd.)

WOVEN CARPET



020061



020055

90-110 Sq. Ft./Gal. (10-12 Sq. Yd.)

DOUBLE GLUE DOWN PAD TO FLOOR



020056

140-170 Sq. Ft./Gal. (15-19 Sq. Yd.)

Permanent Installation



020060

120-140 Sq. Ft./Gal. (13-16 Sq. Yd.)

VINYL SHEET GOODS HOMOGENEOUS VINYL BACKED



020051

Non-Porous Subfloor
200-240 Sq. Ft./Gal. (22-26 Sq. Yd.)



020056

Porous Subfloor
140-170 Sq. Ft./Gal. (15-19 Sq. Yd.)

DOUBLE GLUE DOWN CARPET TO PAD



Smooth Back



020053

55-65 Sq. Ft./Gal. (6-7 Sq. Yd.)

Rough Back



020054

45-55 Sq. Ft./Gal. (5-6 Sq. Yd.)

VINYL COMPOSITION TILE (VCT)



020051

Non-Porous Subfloor
200-240 Sq. Ft./Gal. (22-26 Sq. Yd.)



020056

Porous Subfloor
140-170 Sq. Ft./Gal. (15-19 Sq. Yd.)

*Illustrations do not represent actual size.

VINYL BACKED CARPET



020052

Non-Porous Subfloor
170 -200 Sq. Ft/Gal. (19 -22 Sq. Yd.)

020056

Porous Subfloor
140 -170 Sq. Ft/Gal. (15 -19 Sq. Yd.)

VINYL TILE / VINYL PLANK



020052

Non-Porous Subfloor
170-200 Sq. Ft/Gal. (19 -22 Sq. Yd.)

020056

Porous Subfloor
140 -170 Sq. Ft/Gal. (15 -19 Sq. Yd.)

VINYL SHEET GOODS FELT BACKED



020052

Non-Porous Subfloor
170 -200 Sq. Ft/Gal. (19 -22 Sq. Yd.)

020056

Porous Subfloor
140 -170 Sq. Ft/Gal. (15 -19 Sq. Yd.)

WOOD PLANK SOLID



020058

7/16" Thick or Less
40-45 Sq. Ft/Gal. (4 -5 Sq. Yd.)

049110

1/2" Thick or Greater
30-35 Sq. Ft/Gal. (3-4 Sq. Yd.)

PRE-FINISHED PARQUET



020059

50-60 Sq. Ft/Gal. (5-6 Sq. Yd.)

OR

020057

50-60 Sq. Ft/Gal. (5-6 Sq. Yd.)

CERAMIC TILE SMALL TO MEDIUM FORMAT



049110

Thin-Set Mortar
70 -90 Sq. Ft/50# Bag

ENGINEERED WOOD PLANK



049116

1/4"-5/16" Thick
50-55 Sq. Ft/Gal. (5 -6 Sq. Yd.)

020058

3/8"-9/16" Thick or Less
40-45 Sq. Ft/Gal. (4-5 Sq. Yd.)

049110

≥ 5/8" Thick
30-35 Sq. Ft/Gal. (3-4 Sq. Yd.)

CERAMIC TILE MEDIUM TO LARGE FORMAT



049112

Thin-Set Mortar
60 -65 Sq. Ft/50# Bag

VINYL & RUBBER STAIR TREADS RUBBER RADIAL TILE



020052

Non-Porous Subfloor
170 -200 Sq. Ft/Gal. (19 -22 Sq. Yd.)

020056

Porous Subfloor
140 -170 Sq. Ft/Gal. (15 -19 Sq. Yd.)

CERAMIC TILE LARGE FORMAT & IRREGULAR BACK



049038

1/2" x 1/2" x 1/2" SQ
Thin-Set Mortar
25 -35 Sq. Ft/50# Bag

CERAMIC TILE MOSAIC & SMALL FORMAT WALL



049116

Mastic
50-55 Sq. Ft/Gal. (5 -6 Sq. Yd.)

049110

Thin-Set Mortar
70-90 Sq. Ft/50# Bag

CRACK ISOLATION MAT



049116

Thin-Set Mortar
150 -200 Sq. Ft/50# Bag

SPECIALTY MOULDINGS



Versatile finish pieces that add a high end look to both residential and commercial spaces.

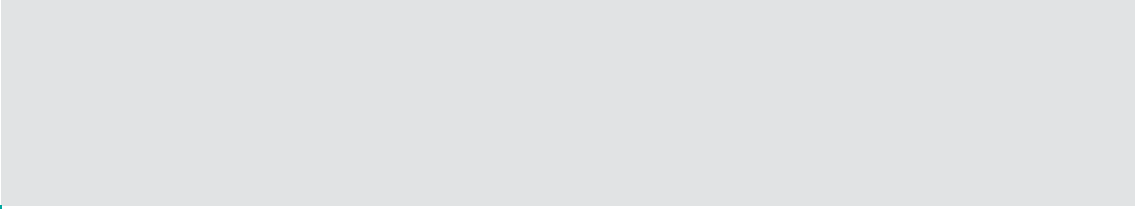

TEE MOULDING

- Versatile metal used for various applications from flooring to door edging.
- Known as Trapdoor Metal.

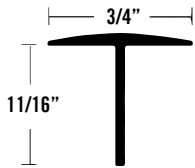

3/4" TEE MOULDING

| ITEM | ITEM DESCRIPTION | LENGTH | QTY | WEIGHT |
|--------|------------------|--------|-----|--------|
| 333600 | 7365 BA | 12' | 12 | 16 |
| 404160 | 7365 BB | 12' | 12 | 16 |

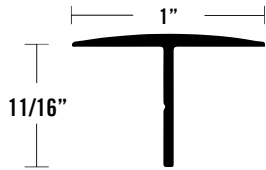

1" TEE MOULDING

| ITEM | ITEM DESCRIPTION | LENGTH | QTY | WEIGHT |
|--------|------------------|--------|-----|--------|
| 333692 | 7395 EA | 12' | 12 | 20 |
| 333690 | 7395 BA | 12' | 12 | 20 |
| 333691 | 7395 BB | 12' | 12 | 20 |



COUNTERTOP & WALLBOARD CAPS

- Caps or J-bar metal can be used as a decorative edging for a variety of panels that vary in thickness.

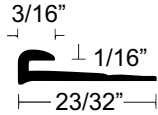

1/16" CAP

| ITEM | ITEM DESCRIPTION | LENGTH | QTY | WEIGHT |
|--------|------------------|--------|-----|--------|
| 410800 | TM 80 MFA | 12' | 40 | 24 |

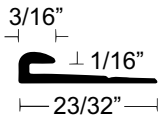

1/16" FLAT BACK CAP

| ITEM | ITEM DESCRIPTION | LENGTH | QTY | WEIGHT |
|--------|------------------|--------|-----|--------|
| 410805 | TM 81 MFA | 12' | 40 | 26 |

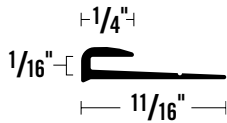

1/16" DEEP SLOT CAP

| ITEM | ITEM DESCRIPTION | LENGTH | QTY | WEIGHT |
|--------|------------------|--------|-----|--------|
| 410820 | TM 84 MFA | 12' | 40 | 26 |

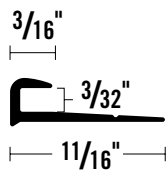

3/32" CAP

| ITEM | ITEM DESCRIPTION | LENGTH | QTY | WEIGHT |
|--------|------------------|--------|-----|--------|
| 410815 | TM 83 MFA | 12' | 40 | 26 |

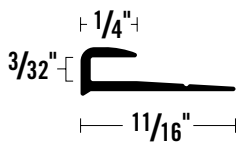

3/32" WIDE FACE CAP

| ITEM | ITEM DESCRIPTION | LENGTH | QTY | WEIGHT |
|--------|------------------|--------|-----|--------|
| 410810 | TM 82 MFA | 12' | 40 | 28 |
| 410811 | TM 82 MFB | 12' | 40 | 28 |

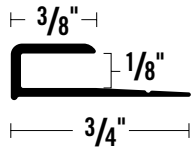

1/8" CAP

| ITEM | ITEM DESCRIPTION | LENGTH | QTY | WEIGHT |
|--------|------------------|--------|-----|--------|
| 442086 | WB 104 EA | 8' | 150 | 84 |
| 442085 | WB 104 BA | 8' | 150 | 84 |

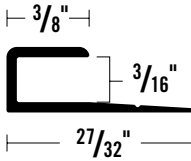

3/16" CAP

| ITEM | ITEM DESCRIPTION | LENGTH | QTY | WEIGHT |
|--------|------------------|--------|-----|--------|
| 410720 | TM 72 BA | 8' | 60 | 28 |

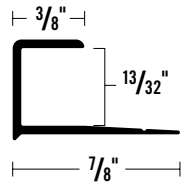

13/32" CAP

| ITEM | ITEM DESCRIPTION | LENGTH | QTY | WEIGHT |
|--------|------------------|--------|-----|--------|
| 334190 | 7524 BA | 12' | 12 | 18 |

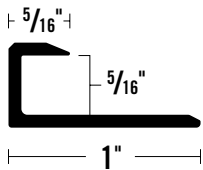

5/16" CAP

| ITEM | ITEM DESCRIPTION | LENGTH | QTY | WEIGHT |
|--------|------------------|--------|-----|--------|
| 350018 | 7358 BBDA | 12' | 12 | 18 |

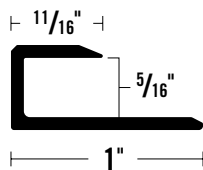

5/16" WIDE FACE CAP

| ITEM | ITEM DESCRIPTION | LENGTH | QTY | WEIGHT |
|--------|------------------|--------|-----|--------|
| 350017 | 7359 BBDA | 12' | 12 | 18 |

COUNTERTOP & WALLBOARD COVES



- Coves are applied to a corner when a radius is required on counter tops, wall base, or back splashes.

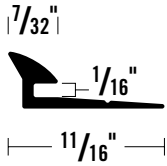

| 1/16" CAP | | | | |
|-----------|------------------|--------|-----|--------|
| ITEM | ITEM DESCRIPTION | LENGTH | QTY | WEIGHT |
| 410905 | TM 91 MFA | 12' | 40 | 30 |
| 410906 | TM 91 MFB | 12' | 40 | 30 |

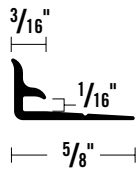

| 1/16" COVE | | | | |
|------------|------------------|--------|-----|--------|
| ITEM | ITEM DESCRIPTION | LENGTH | QTY | WEIGHT |
| 410910 | TM 92 MFA | 12' | 40 | 24 |
| 410911 | TM 92 MFB | 12' | 40 | 24 |

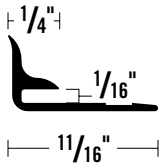

| 1/16" COVE | | | | |
|------------|------------------|--------|-----|--------|
| ITEM | ITEM DESCRIPTION | LENGTH | QTY | WEIGHT |
| 410935 | TM 98 MFA | 12' | 40 | 35 |

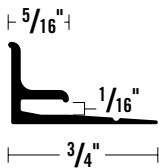

| 1/16" COVE | | | | |
|------------|------------------|--------|-----|--------|
| ITEM | ITEM DESCRIPTION | LENGTH | QTY | WEIGHT |
| 410900 | TM 90 MFA | 12' | 40 | 44 |

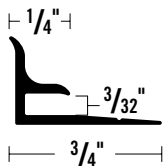

| 3/32" COVE | | | | |
|------------|------------------|--------|-----|--------|
| ITEM | ITEM DESCRIPTION | LENGTH | QTY | WEIGHT |
| 410585 | TM 85 MFA | 12' | 40 | 41 |

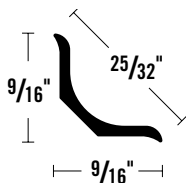

| 25/32" OFFSET DRILL COVE | | | | |
|--------------------------|------------------|--------|-----|--------|
| ITEM | ITEM DESCRIPTION | LENGTH | QTY | WEIGHT |
| 410520 | TM 52 BA | 12' | 40 | 37 |

COUNTERTOP & WALLBOARD DIVIDERS

- Aluminum dividers are used to join wall, ceiling or floor panels together.

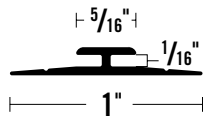

1/16" DIVIDER

| ITEM | ITEM DESCRIPTION | LENGTH | QTY | WEIGHT |
|--------|------------------|--------|-----|--------|
| 410920 | TM 94 BA | 12' | 40 | 36 |

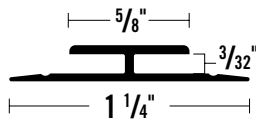

3/32" DIVIDER

| ITEM | ITEM DESCRIPTION | LENGTH | QTY | WEIGHT |
|--------|------------------|--------|-----|--------|
| 442057 | WB 110 EA | 8' | 50 | 44 |

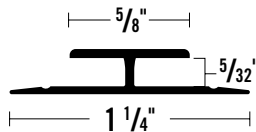

5/32" DIVIDER

| ITEM | ITEM DESCRIPTION | LENGTH | QTY | WEIGHT |
|--------|------------------|--------|-----|--------|
| 442050 | WB 103 BA | 8' | 100 | 66 |

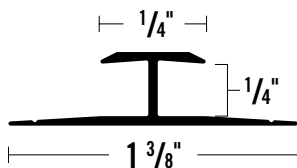

1/4" DIVISION

| ITEM | ITEM DESCRIPTION | LENGTH | QTY | WEIGHT |
|--------|------------------|--------|-----|--------|
| 443010 | WB 303 BA | 8' | 100 | 85 |



COUNTERTOP & WALLBOARD OUTSIDE CORNER

- Outside corners can be used with woodworking or finished ceramic edges with a modern sleek look.

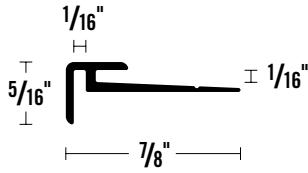

1/16" OUTSIDE CORNER

| ITEM | ITEM DESCRIPTION | LENGTH | QTY | WEIGHT |
|--------|------------------|--------|-----|--------|
| 410915 | TM 93 BA | 12' | 40 | 41 |



FACING

- Face nosing is used in a wide range of applications from table, counter tops, shelves, or stair tread guarding.

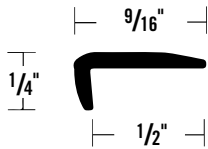

1/2" PLAIN FACING

| ITEM | ITEM DESCRIPTION | LENGTH | QTY | WEIGHT |
|--------|------------------|--------|-----|--------|
| 410195 | TM 19 BA | 12' | 40 | 26 |
| 410196 | TM 19 BN | 12' | 24 | 17 |

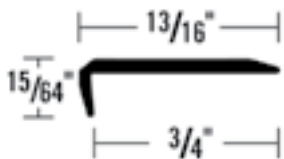

3/4" PLAIN FACING

| ITEM | ITEM DESCRIPTION | LENGTH | QTY | WEIGHT |
|--------|------------------|--------|-----|--------|
| 410210 | TM 21 BA | 12' | 40 | 34 |

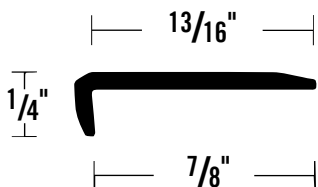

7/8" PLAIN FACING

| ITEM | ITEM DESCRIPTION | LENGTH | QTY | WEIGHT |
|--------|------------------|--------|-----|--------|
| 410230 | TM 23 BA | 12' | 40 | 45 |

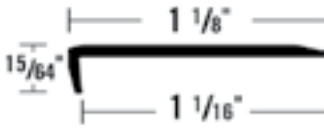

1 - 1/16" PLAIN FACING

| ITEM | ITEM DESCRIPTION | LENGTH | QTY | WEIGHT |
|--------|------------------|--------|-----|--------|
| 410250 | TM 25 BA | 12' | 40 | 46 |

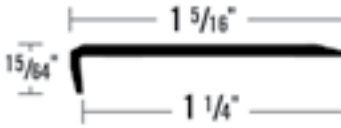

1 - 1/4" PLAIN FACING

| ITEM | ITEM DESCRIPTION | LENGTH | QTY | WEIGHT |
|--------|------------------|--------|-----|--------|
| 410240 | TM 24 BA | 12' | 40 | 53 |

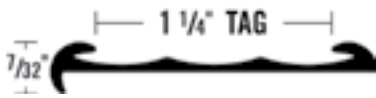

1 - 1/4" PRICE TAG CONVENTIONAL MOULDING

| ITEM | ITEM DESCRIPTION | LENGTH | QTY | WEIGHT |
|--------|------------------|--------|-----|--------|
| 331940 | 0569 BA | 12' | 12 | 16 |

INSERT "T"

- Used for store fixtures, displays and ceramic finishes.
- Can also be used as a ceramic trim to prevent tile edges from chipping or cracking.



13/16" INSERT OVAL TEE

| ITEM | ITEM DESCRIPTION | LENGTH | QTY | WEIGHT |
|--------|------------------|--------|-----|--------|
| 335916 | 0923 EA | 12' | 12 | 17 |

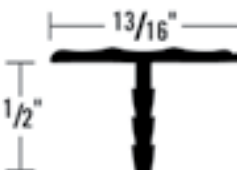

13/16" PALISADE INSERT TEE

| ITEM | ITEM DESCRIPTION | LENGTH | QTY | WEIGHT |
|--------|------------------|--------|-----|--------|
| 350027 | 7364 EA | 12' | 12 | 16 |



PANEL HANGER

- Ideal for hanging wall panels, frames, or cabinets.
- Easy to install and provides a strong hold



| PANEL HANGER | | | | |
|--------------|------------------|--------|-----|--------|
| ITEM | ITEM DESCRIPTION | LENGTH | QTY | WEIGHT |
| 350072 | 7389 MF | 12' | 12 | 32 |



SLAT WALL PANEL

- Commercial or residential use for displaying or organizing a variety of tools and merchandise.
- Utilizes hooks that allows easy and quick storage options.

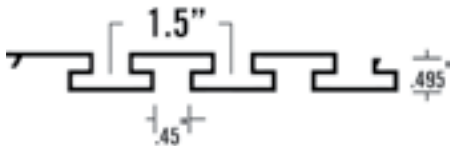

| SLAT WALL PANEL | | | | |
|-----------------|------------------|--------|-----|--------|
| ITEM | ITEM DESCRIPTION | LENGTH | QTY | WEIGHT |
| 599900 | 7584 MF | 12' | 1 | 9 |

1/8" FLAT BAR

- Light weight and used for many different fabrication applications.
- Used for framework, braces, supports, and trims

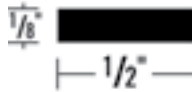

1/2" x 1/8" FLAT BAR

| ITEM | ITEM DESCRIPTION | LENGTH | QTY | WEIGHT |
|--------|------------------|--------|-----|--------|
| 300030 | 1005 EA | 12' | 6 | 8 |

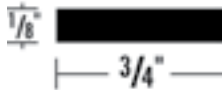

3/4" x 1/8" FLAT BAR

| ITEM | ITEM DESCRIPTION | LENGTH | QTY | WEIGHT |
|--------|------------------|--------|-----|--------|
| 300220 | 1048 EA | 12' | 6 | 11 |
| 300225 | 1048 MF | 12' | 50 | 71 |

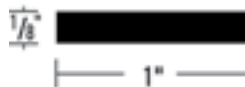

1" x 1/8" FLAT BAR

| ITEM | ITEM DESCRIPTION | LENGTH | QTY | WEIGHT |
|--------|------------------|--------|-----|--------|
| 300020 | 1004 EA | 12' | 6 | 14 |

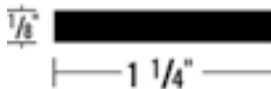

1 - 1/4" x 1/8" FLAT BAR

| ITEM | ITEM DESCRIPTION | LENGTH | QTY | WEIGHT |
|--------|------------------|--------|-----|--------|
| 300306 | 1068 EA | 12' | 6 | 17 |

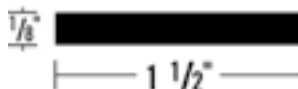

1 - 1/2" x 1/8" FLAT BAR

| ITEM | ITEM DESCRIPTION | LENGTH | QTY | WEIGHT |
|--------|------------------|--------|-----|--------|
| 300228 | 1049 EA | 12' | 6 | 19 |



ANGLE

- Angles come in a variety of different sizes for all applications.
- Used for constructing frames, bases, table tops, and counter top edging
- Applications range from decorative moldings, trims, and corners.

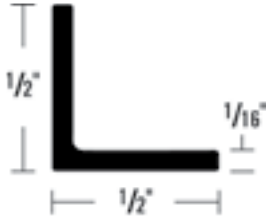

1/2" EQUAL ANGLE

| ITEM | ITEM DESCRIPTION | LENGTH | QTY | WEIGHT |
|--------|------------------|--------|-----|--------|
| 276001 | 3141 EA | 8' | 6 | 6 |
| 306001 | 3141 EA | 12' | 6 | 8 |

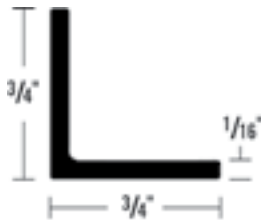

3/4" EQUAL ANGLE

| ITEM | ITEM DESCRIPTION | LENGTH | QTY | WEIGHT |
|--------|------------------|--------|-----|--------|
| 276051 | 3151 EA | 8' | 6 | 8 |
| 306051 | 3151 EA | 12' | 6 | 11 |

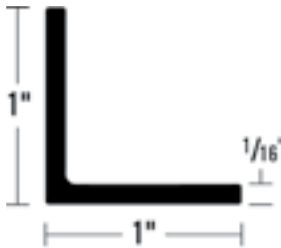

1" EQUAL ANGLE

| ITEM | ITEM DESCRIPTION | LENGTH | QTY | WEIGHT |
|--------|------------------|--------|-----|--------|
| 276101 | 3161 EA | 8' | 6 | 13 |
| 306101 | 3161 EA | 12' | 6 | 13 |



3/4" x 3/8" ANGLE

| ITEM | ITEM DESCRIPTION | LENGTH | QTY | WEIGHT |
|--------|------------------|--------|-----|--------|
| 302651 | 1750 EA | 12' | 6 | 11 |



3/4" x 1/2" ANGLE

| ITEM | ITEM DESCRIPTION | LENGTH | QTY | WEIGHT |
|--------|------------------|--------|-----|--------|
| 300651 | 1225 EA | 12' | 6 | 8 |



1" x 1/2" ANGLE

| ITEM | ITEM DESCRIPTION | LENGTH | QTY | WEIGHT |
|--------|------------------|--------|-----|--------|
| 300158 | 1033 EA | 12' | 6 | 14 |



3/4" EQUAL ANGLE

| ITEM | ITEM DESCRIPTION | LENGTH | QTY | WEIGHT |
|--------|------------------|--------|-----|--------|
| 300083 | 1017 EA | 12' | 6 | 18 |



1" EQUAL ANGLE

| ITEM | ITEM DESCRIPTION | LENGTH | QTY | WEIGHT |
|--------|------------------|--------|-----|--------|
| 300091 | 1018 EA | 12' | 6 | 23 |
| 350053 | 1018 MF | 12' | 6 | 23 |

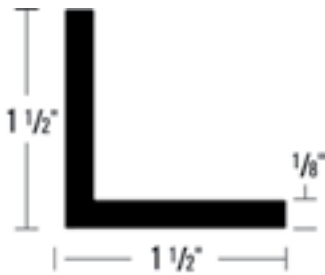

1 - 1/2" EQUAL ANGLE

| ITEM | ITEM DESCRIPTION | LENGTH | QTY | WEIGHT |
|--------|------------------|--------|-----|--------|
| 300110 | 1022 EA | 12' | 6 | 34 |

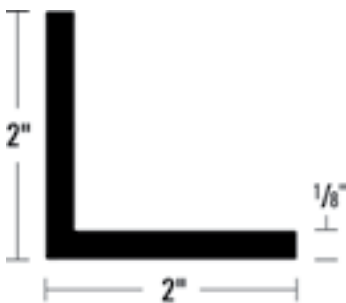

2" EQUAL ANGLE

| ITEM | ITEM DESCRIPTION | LENGTH | QTY | WEIGHT |
|--------|------------------|--------|-----|--------|
| 300450 | 1137 EA | 12' | 6 | 45 |

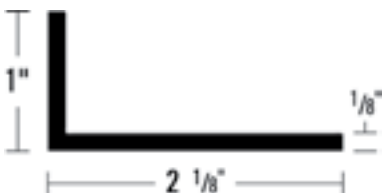

2 - 1/8" X 1" ANGLE

| ITEM | ITEM DESCRIPTION | LENGTH | QTY | WEIGHT |
|--------|------------------|--------|-----|--------|
| 300751 | 1249 EA | 12' | 6 | 35 |



CHANNEL

- Channels come in a variety of different sizes for all applications.
- Channels are perfect for framing and protecting edges.
- Store display, fixtures, glass and window applications.



7/16" X 1/4" CHANNEL

| ITEM | ITEM DESCRIPTION | LENGTH | QTY | WEIGHT |
|--------|------------------|--------|-----|--------|
| 301151 | 1347 EA | 12' | 6 | 9 |

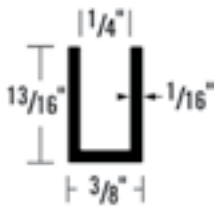

13/16" X 1/4" CHANNEL

| ITEM | ITEM DESCRIPTION | LENGTH | QTY | WEIGHT |
|--------|------------------|--------|-----|--------|
| 304001 | 2223 EA | 12' | 6 | 13 |

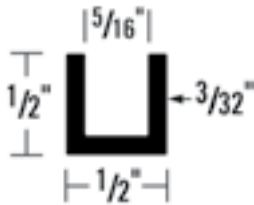

1/2" X 5/16" CHANNEL

| ITEM | ITEM DESCRIPTION | LENGTH | QTY | WEIGHT |
|--------|------------------|--------|-----|--------|
| 300178 | 1038 EA | 12' | 6 | 14 |

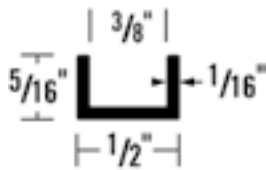

5/16" X 3/8" CHANNEL

| ITEM | ITEM DESCRIPTION | LENGTH | QTY | WEIGHT |
|--------|------------------|--------|-----|--------|
| 300895 | 1285 EA | 12' | 6 | 8 |



5/16" X 1/2" CHANNEL

| ITEM | ITEM DESCRIPTION | LENGTH | QTY | WEIGHT |
|--------|------------------|--------|-----|--------|
| 301201 | 1362 EA | 12' | 6 | 9 |

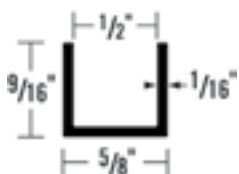

9/16" X 1/2" CHANNEL

| ITEM | ITEM DESCRIPTION | LENGTH | QTY | WEIGHT |
|--------|------------------|--------|-----|--------|
| 301143 | 1346 EA | 12' | 6 | 12 |

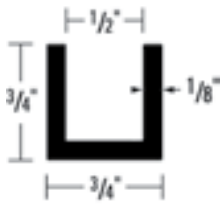

3/4" X 1/2" CHANNEL

| ITEM | ITEM DESCRIPTION | LENGTH | QTY | WEIGHT |
|--------|------------------|--------|-----|--------|
| 301901 | 1538 EA | 12' | 6 | 25 |

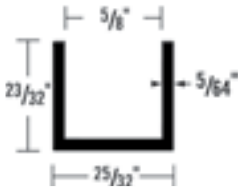

23/32" X 5/8" CHANNEL

| ITEM | ITEM DESCRIPTION | LENGTH | QTY | WEIGHT |
|--------|------------------|--------|-----|--------|
| 301139 | 1345 EA | 12' | 6 | 17 |

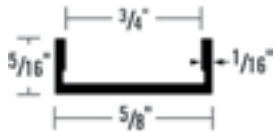

5/16" X 3/4" CHANNEL

| ITEM | ITEM DESCRIPTION | LENGTH | QTY | WEIGHT |
|--------|------------------|--------|-----|--------|
| 303751 | 2161 EA | 12' | 6 | 10 |

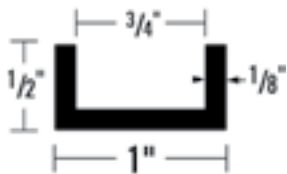

1/2" X 3/4" CHANNEL

| ITEM | ITEM DESCRIPTION | LENGTH | QTY | WEIGHT |
|--------|------------------|--------|-----|--------|
| 300187 | 1040 EA | 12' | 6 | 22 |

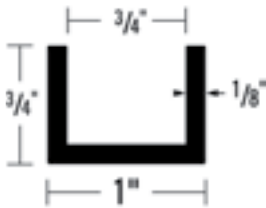

3/4" X 3/4" CHANNEL

| ITEM | ITEM DESCRIPTION | LENGTH | QTY | WEIGHT |
|--------|------------------|--------|-----|--------|
| 302501 | 1710 EA | 12' | 6 | 27 |

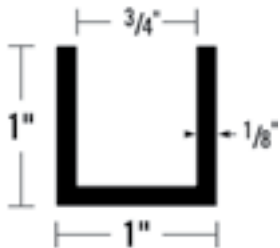

1" X 3/4" CHANNEL

| ITEM | ITEM DESCRIPTION | LENGTH | QTY | WEIGHT |
|--------|------------------|--------|-----|--------|
| 300191 | 1041 EA | 12' | 6 | 33 |

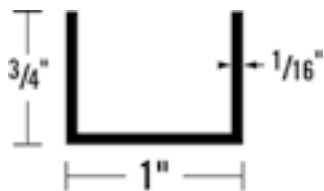

1" X 3/4" TOP CHANNEL

| ITEM | ITEM DESCRIPTION | LENGTH | QTY | WEIGHT |
|--------|------------------|--------|-----|--------|
| 350042 | 7347 EA | 12' | 6 | 16 |

Warranty

Seller warrants that the product(s) supplied by Seller shall be free from defects in workmanship and material and shall conform to the descriptions and specifications, if any, set forth or incorporated by reference in this Agreement. The foregoing warranty only applies to the quality of the goods at the time of delivery, and Seller makes no representation as to the durability or service life of the product. SELLER DISCLAIMS ANY OTHER WARRANTY, EXPRESS OR IMPLIED, WHETHER CREATED BY CONTRACT, BY STATUTE OR OTHERWISE BY OPERATION OF LAW, INCLUDING ALL WARRANTIES OF MERCHANTABILITY AND FITNESS FOR A PARTICULAR PURPOSE.

Aluminum Material Information

- Futura Transitions items are extruded in the USA by Bonnell Aluminum with various 6000 series alloys.
- Bonnell Aluminum is ISO 9001: 2015 Certified.
- Futura Transitions products are made from conflict-free materials.
- Futura Transitions products are ROHS and REACH compliant.
- Futura Transitions products are free of hazardous materials and do not require an MSDS.

Aluminum Maintenance

- Futura Transitions aluminum trims and transitions can be cleaned with non-abrasive, non-harsh chemical cleaning products. Test a small section of the aluminum to ensure that any cleaner to be used will not adversely affect the appearance of the metal.



Futura Transitions
Bldg. H-11 Freeport Center
PO Box 160350
Clearfield, UT 84016

800 824 2049
futura.transitions@bonnellaluminum.com
www.futura.transitions.com



FUTURA

TRANSITIONS

by **Bonnell Aluminum**

BONNELL ALUMINUM

Bldg. H-11 Freeport Center

Post Office Box 160350

Clearfield, UT 84016

www.futuratransitions.com

800.824.2049