



FUTURA

TRANSITIONS

by **Bonnell Aluminum**

COMMERCIAL & RESIDENTIAL TRIMS & TRANSITIONS CATALOG

Jan 2024

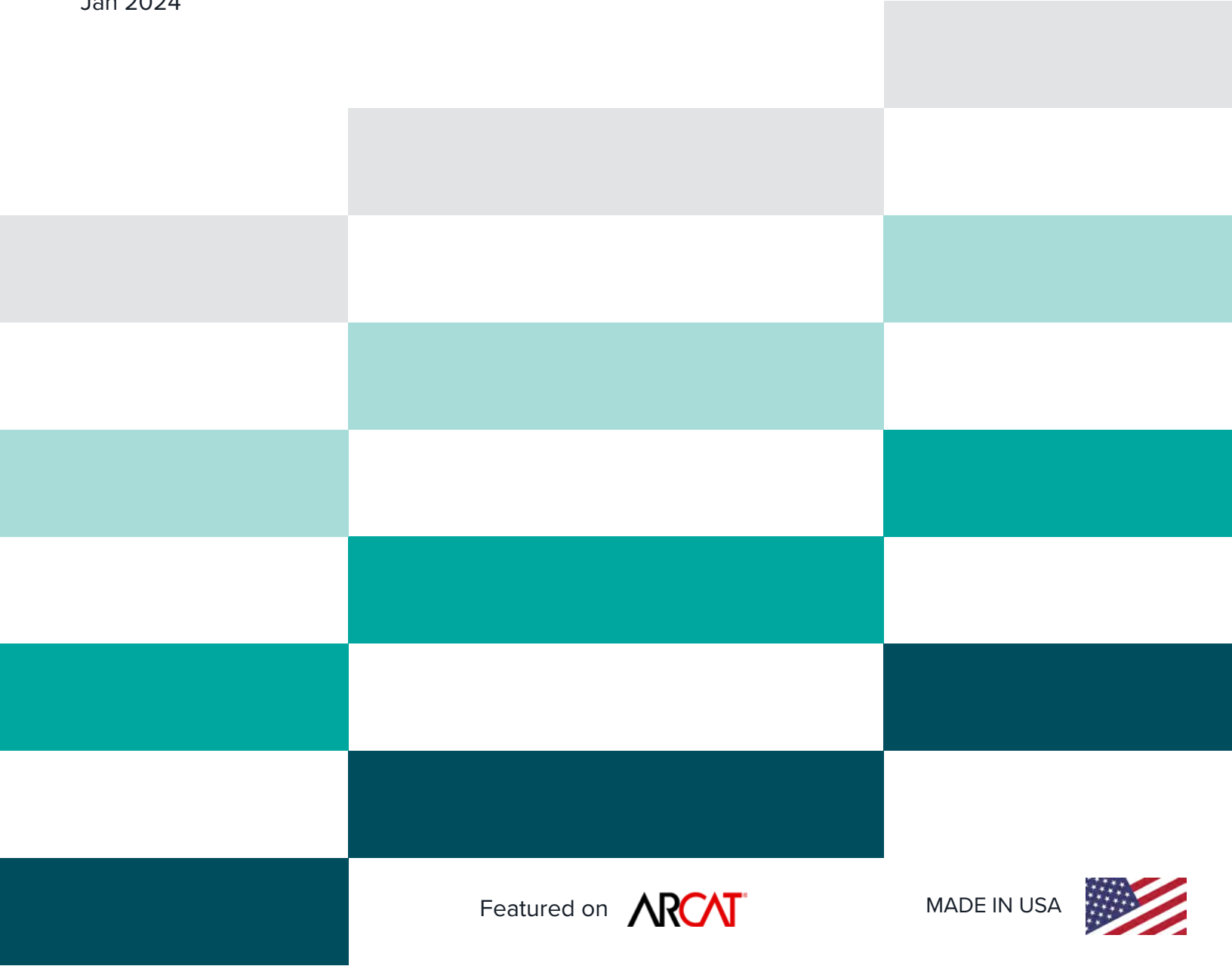

Featured on **ARCAT**

MADE IN USA



TRANSITION FINDER

Material Height	Bare Floor	2.5mm	3mm	3.5mm	4mm	4.5mm	5mm	6mm	7mm	8mm	14mm	15mm	Carpet Tile / Glue Down	Ceramic Tile
Bare Floor		LVT425	LVT113 LVT406 LVT303				LVT115						LVT160 LVT115	
2.5mm	LVT425	LVT102	LVT128	LVT123		LVT124			LVT129			LVT126	LVT124	
3mm	LVT113 LVT406 LVT303	LVT128	LVT103 LVT102 LVT133			LVT125	LVT127 LVT350						LVT125 LVT130 LVT131 LVT350	ETR38 TLVT516 TLVT38
3.5mm		LVT123												
4mm					LVT102								LVT904	
4.5mm		LVT124	LVT125						LVT121			LVT120		
5mm	LVT115		LVT127 LVT350				LVT105 LVT102 LVT155						LVT150 LVT905	
6mm								LVT102			LVT119			
7mm		LVT129				LVT121			LVT102			LVT122		
8mm										LVT102				
14mm								LVT119						
15mm		LVT126				LVT120			LVT122			LVT102		
Carpet Tile / Glue Down	LVT160 LVT115	LVT124	LVT125 LVT130 LVT131 LVT350		LVT904		LVT150 LVT905						LVT105	
Ceramic Tile			ETR38 TLVT516 TLVT38											

*48 HOUR GUARANTEE



Items listed with the 48 Hour Guarantee icon are guaranteed to ship from the factory to the distributor in 48 hours or less from the time a purchase order is received and we ship the product. 48 Hour Guarantee does not apply if ordering more than your average number of pieces within the last 6 month period.

Trims and Transitions for Commercial and Residential Flooring and Wall Projects



Futura Industries has long been the market leader and producer of luxury aluminum trims and transitions for most flooring types in both commercial and residential settings. Originally known as Colotrym in the 1950s and largely focused on solutions for stretch carpet we made being number one in quality, value and service to our customers our top priority. In 1964, Colotrym became Futura and we spent the next 55 years adding innovative solutions to our product line including trims and transitions for ceramic installations as well as LVT and resilient flooring. In 2017, Futura was purchased by Bonnell Aluminum, one of the largest domestic manufacturers of extruded aluminum.

We are proud to reveal our new logo and updated name, **Futura Transitions**. The logo colors pay homage to our past, present and future while communicating our determination to create innovative solutions for our customers. The definition of transition is “the process of changing from one state or condition to another.” Our flooring products don’t just transition from one flooring product to another. They change decorative trim to durable and sustainable luxury edge protection. They take an installation challenge and transform it into a feature that compliments the entire space. In short, using Futura Transitions flooring products transitions a flooring project from average to remarkable!

Futura Transitions products are sold through trusted pro-channel distributors in the US and Canada who count on exceptional customer service, consistent lead times and the 48 hour guarantee* offered on our most popular products. Our aluminum transitions and trims are manufactured in the USA and are available in a variety of premium finishes and sizes that compliment current trends in fixtures and flooring styles.

For more information visit us at www.futuratransitions.com or call 1.800.824.2049 to find a distributor near you.

Architects / Designers / Engineers / Facility Managers



ARCAT PHILOSOPHY: "To publish quality products for architects, engineers and specifiers to enable them to easily specify ARCAT building product manufacturer clients." ARCAT is the leading online resource of free building product information. With a CAD library of over 7000 product lines ARCAT provides architects, engineers and designers the ability to find the products they need for their projects. **Visit www.arcat.com and search for Futura Transitions today!**

ADA COMPLIANCE

Many of the trims and transitions offered by Futura Transitions are compatible with ADA 2010 Standards section 303 Changes in Level and section 504.5 Nosings. However, installers and contractors must ensure that the finished installation, including any Futura Transitions product complies with current ADA standards when the project specifies an ADA requirement. **For more information on ADA standards visit https://www.ada.gov/2010ADASTandards_index.htm**

CONTENTS

► CATALOG INFORMATION

Commercial & Residential Trim Finder	2
Aluminum Finishes	7
New Products	8 - 13

► WARRANTY

Warranty, material and maintenance information	107
--	-----

► CARPET METAL TRIMS

½" Standard Pin Clampdown (CM 104, CM3703, CM 3703 Flex)	15
9/16" Standard Pin Clampdown (CM 95, CM 12-2114, CM 12-2117, CM 12-2118)	15
½" Premium Pin Clampdown (CM 102, CM 106 Flex)	16
9/16" Premium Pin Clampdown (CM 101, CM 105 Flex, CM 3705, CM 3705 Flex)	16
5/8" Premium Pin Clampdown (CM 100, CM 109 Flex)	16
11/16" Premium Pin Clampdown (CM 3704)	16
¾" Premium Pin Clampdown (CM 99A, CM 107A Flex)	17
¾" Deluxe Pin Clampdown (CM 99, CM 107 Flex, CM 654, CM 654 Flex)	17
1" Commercial Pin Clampdown (CM 103)	17
½" Premium Pinless Clampdown (CM 201, CM205 Flex)	18
9/16" Deluxe Pinless Clampdown (CM 211, CM 211 Flex)	18
11/16" Blank Clampdown for Tack Strips (CM 121)	19
Carpet Tile Joiner (CM 308)	19
1 ½" Joiner with Pins (CM 108)	19
1 12/32" Pinless Joiner (CM 208)	20
1 9/16" Joiner with Pins (CM 112)	20
1 ½" Pinless Joiner (CM 212)	20
1 3/8" Vinyl Insert Carpet Metal with Pins (CM 110, CM 110 Flex)	20
1 9/16" Vinyl Insert Carpet Metal with Pins (CM 3750)	21
1 3/8" Vinyl Insert Carpet Metal with Pins / Extender (CM 115)	21
1 3/8" Vinyl Insert Carpet Metal with Pins (Canadian) (CM 310, CM 310 Flex)	21
1 ¼" Vinyl Insert Pinless Carpet Metal (CM 210, CM 210 Flex)	21
1 ¼" Vinyl Insert Pinless / Extender (CM 215)	21
1 ¼" Vinyl Insert Pinless Trim (Canadian)(CM 410, CM 410 Flex)	22
1 ¼" Vinyl Single Flange Track (VT 253 White)	22

► Z-BAR, BINDER BARS & CARPET BAR

1" Standard Binder Bar (CM 313)	22
1" Deluxe Binder Bar (CM 303)	22
1 ½" Standard Binder Bar (CM 312)	23
1 ½" Premium Binder Bar (CM 302)	23
2" Deluxe Binder Bar (CM 304)	23
2 ½" Deluxe Binder Bar (CM 315, CM 305)	24
¾" Binder Bar - Overlap Edging (CM 701)	24
Z-Bar	24
¾" Seam Binder (CM 702)	24
1" Seam Binder (CM 705)	25
1 ¼" Seam Binder (CM 703)	25
2 ½" Seam Binder (CM 704)	26
4" Seam Binder (CM 714)	26

► STAIR NOSING

1 1/16" Deluxe Stair Nosing (CM 601)	26
1 1/16" Standard Stair Nosing (CM 611)	26
1 5/8" Deluxe Stair Nosing (CM 605)	27
1 5/8" Standard Wide Tread Stair Nosing (CM 615)	27
1 7/8" Deluxe Stair Nosing (CM 627)	27
2" Standard Wide Tread Stair Nosing (CM 617)	28
2" Deluxe Stair Nosing (CM 607, CM 648)	28
2" Deluxe Stair Nosing (CM 637)	29
2 1/2" Commercial Stair Nosing (CM 603)	29
3 1/4" Commercial Stair Nosing (CM 609)	30
3 1/2" Commercial Stair Nosing (CM 619)	30
5/32" 4mm LVT Stair Nosing (LVT 606)	30
3/16" 5mm LVT Stair Nosing (LVT 608)	31
3/16" 5mm LVT Stair Nosing (LVT 610)	31
15/64" 6mm LVT Stair Nosing (LVT 604)	31
4mm Scribe-To Stair Nosing (CM 602)	31
4mm No-Lip Stair Nosing (LVT 343)	32
5mm No-Lip Stair Nosing (LVT 341)	32
5mm 80 degree No-Lip Stair Nosing (LVT 347)	32
4mm No-Lip Stair Riser (LVT 333)	32
5mm No-Lip Stair Riser (LVT 331)	32
5mm 80 degree No-Lip Stair Riser (LVT 337)	32
Drive Nails	33
Straight Edge	33

► COVING, SQUARE & BEVEL CAPS

3/32" Coving Cap (CM 903)	34
1/8" Coving Cap (CM 901)	34
1/4" Coving Cap (CM 401)	34
1/4" Round Coving Cap (CM 400)	35
5/32" 4mm Square Cap (CM 904)	35
3/16" 5mm Square Cap (CM 905)	35
5/16" 5mm Square Cap Ext Lip (CM 915)	35
5/32" 4mm Bevel Cap (CM 404)	35
3/16" 5mm Bevel Cap (CM 405)	35

► CARPET REDUCERS

1/8" 3mm Carpet Tile to LVT (LVT 130, LVT 130-FLEX)	36
3/16" 5mm Carpet to Tile LVT (LVT 150, LVT 150-FLEX)	36
3/16" 3mm Carpet Tile to LVT/Bare Floor (LVT 131)	36
Carpet to 9mm (LVT 190)	36
1/8" 3mm Carpet Tile to LVT (LVT 350)	37
3/16" 5mm Carpet Tile to LVT/Bare Floor (LVT 160, LVT 160-FLEX)	37
13/64" 5mm Carpet Tile Reducer (LVT 115)	37

► SAFETY STAIR NOSING / TREDSAFE® INSERTS

Carpet Safety Stair Nosing 1 - 1/2" drop (AA121)	39
Carpet Safety Stair Nosing 2" drop (AA123)	39
Carpet Safety Stair Nosing 1 - 3/8" drop (AA345)	39
Carpet Safety Stair Nosing 1 - 3/8" drop (AA346)	40
Ceramic Safety Stair Nosing 3/4" drop (AA351)	40
Bare Floor Safety Stair Nosing 2" drop (AA125)	41
Safety Joiner for Vinyl (DT025)	42
Safety Joiner for Carpet (DT026)	42
Safety Transition for Carpet to Vinyl (DT024)	43
Safety Transition for Carpet to 3mm LVT (DT027)	43
Safety Transition for Carpet to Bare Floor (DT028)	43
Safety Transition for Carpet to 5mm LVT (DT029)	43
Tredsafe Inserts	44
Tredsafe Installation Instructions	46

► LVT FLOORING TRIMS & TRANSITIONS

2.5mm to 3.5mm LVT No-Lip Ramp (LVT 123)	49
2.5mm to 4.5mm LVT No-Lip Ramp (LVT 124)	49
3mm to 4.5mm LVT No-Lip Ramp (LVT 125, LVT 125-FLEX)	49
3mm to 5mm LVT No-Lip Ramp (LVT 127)	49
2mm to 5mm LVT No-Lip Ramp (LVT 118)	49
4.5mm to 7mm LVT No-Lip Ramp (LVT 121)	50
2.5mm to 7mm LVT No-Lip Ramp (LVT 129)	50
2.5mm to 3mm LVT No-Lip Ramp (LVT 128)	50
3mm to 3mm LVT No-Lip Ramp (LVT 133)	50
5mm to 5mm LVT No-Lip Ramp (LVT 155)	50
14mm to 6mm LVT No-Lip Ramp (LVT 119)	51
4.5mm to 15mm LVT No-Lip Ramp (LVT 120)	51
7mm to 15mm LVT No-Lip Ramp (LVT 122)	51
3mm to 15mm LVT No-Lip Ramp (LVT 126)	51
3mm Carpet Tile to LVT (LVT 130, LVT 130-FLEX)	52
5mm Carpet to Tile LVT (LVT 150, LVT 150-FLEX)	52
3mm Carpet Tile to LVT/Bare Floor (LVT 131)	52
5mm Carpet Tile to LVT/Bare Floor (LVT 160, LVT 160-FLEX)	53
Carpet to 9mm (LVT 190)	53
3mm Carpet Tile to LVT (LVT 350)	53
2.5mm No-Lip Stair Nosing (LVT 325)	54
3mm No-Lip Stair Nosing (LVT 340)	54
4mm No-Lip Stair Nosing (LVT 343)	54
5mm No-Lip Stair Nosing (LVT 341)	55
6mm No-Lip Stair Nosing (LVT 346)	55
3mm 80 degree No-Lip Stair Nosing (LVT 342)	55
5mm 80 degree No-Lip Stair Nosing (LVT 347)	55
3mm No-Lip Stair Riser (LVT 330)	56
4mm No-Lip Stair Riser (LVT 333)	56
5mm No-Lip Stair Riser (LVT 331)	56
6mm No-Lip Stair Riser (LVT 336)	56
3mm 80 degree No-Lip Stair Riser (LVT 332)	57
5mm 80 degree No-Lip Stair Riser (LVT 337)	57
2.5mm LVT Stair Nosing (LVT 625)	58
3mm LVT Stair Nosing (LVT 630)	58

4mm LVT Stair Nosing (LVT 606)	58
5mm LVT Stair Nosing (LVT 608)	59
5mm LVT Stair Nosing Long (LVT 610)	59
6mm LVT Stair Nosing (LVT 604)	59
7mm LVT Stair Nosing (LVT 612)	59
8mm LVT Stair Nosing (LVT 618)	60
8mm LVT Stair Nosing (LVT 622)	60
2.5mm Bevel Cap (LVT 425)	60
3mm Bevel Cap (LVT 406)	61
4mm Bevel Cap (LVT 404)	61
5mm Bevel Cap (LVT 405)	61
7mm Bevel Cap (LVT 407)	61
8mm Bevel Cap (LVT 408)	61
2.5mm Square Cap (LVT 925)	62
3mm Square Cap (LVT 906)	62
4mm Square Cap (LVT 904)	62
5mm Square Cap (LVT 905)	62
5mm Square Cap Ext Lip (LVT 915)	62
7mm Square Cap (LVT 907)	63
8mm Square Cap (LVT 908)	63
10mm Square Cap (LVT 910)	63
12mm Square Cap (LVT 912)	63
3/8" Existing Ceramic Tile to LVT 3mm+ (ETR 38)	64
5/16" Ceramic Tile to LVT 3mm (Edgetek TLVT 516)	64
3/8" Ceramic Tile to LVT 3mm (Edgetek TLVT 38)	64
2.5mm LVT Joiner (LVT 102)	65
3mm LVT Joiner (LVT 103)	65
5mm LVT Joiner (LVT 105)	65
3mm LVT Reducer (LVT 113)	66
5mm LVT Reducer (LVT 115)	66
3mm LVT Reducer (LVT 303)	66

► CERAMIC FLOORING TRIMS

1/4" Edgetek L Shape (Edgetek L 14)	69
1/4" Tile Trim (TT 14)	69
5/16" Edgetek L Shape (Edgetek L 516)	69
5/16" Tile Trim (TT 516)	69
3/8" Edgetek L Shape (Edgetek L 38)	69
3/8" Tile Trim (TT 38)	70
1/2" Edgetek L Shape (Edgetek L 12)	70
1/2" Tile Trim (TT 12)	70
5/8" Tile Trim (TT 58)	70
3/8" Ceramic Quarter Round (TQ 38)	70
5/16" Edgetek Tile Reducer (Edgetek U 516)	71
3/8" Edgetek Tile Reducer (Edgetek U 38)	71
1/2" Edgetek Tile Reducer (Edgetek U 12)	71
3/8" Existing Ceramic Tile to LVT 3mm+ (ETR 38)	72
5/16" Edgetek Tile to LVT (Edgetek TLVT 516)	72
3/8" Edgetek Tile to LVT (Edgetek TLVT 38)	72
5/16" Edgetek Carpet Tuck (Edgetek CT 516)	73
3/8" Edgetek Carpet Tuck (Edgetek CT 38)	73

CONTENTS (Continued)



5/16" Edgetek Tile Bull nose (Edgetek R 516)	74
3/8" Edgetek Tile Bull nose (Edgetek R 38)	74
5/16 Edgetek Square Corner (Edgetek Q 516)	74
3/8" Edgetek Square Corner (Edgetek Q 38)	74
5/16" R Corner	75
3/8" R Corner	75
5/16" Q Corner	75
3/8" Q Corner	75
5/16" Stair Nosing (Edgetek TS 516)	76
3/8" Stair Nosing (Edgetek TS 38)	76
3/8" Stair Nosing (Edgetek SE 38)	76
3/8" Edgetek Step (Edgetek Step 38)	77
9/16" T-Seam Binder (Edgetek T 916)	77

▶ VINYL TRIMS

Cove Stick (PVC) for Sheet Vinyl (VT 051, VT 052)	79
Reducer For Glue-Down Carpet (VT 320)	79
Reducer For Glue-Down Carpet (VT 333, VT 332, VT 331)	80
Over The Top Resilient Reducer (VT 326)	80
Tile Reducer For Resilient Floors (VT 324, VT 325)	81
Tile and Carpet Joiner (VT 754, VT 756)	81
Stair Nosing (VT 640, VT 642, VT 641, VT 644)	82
Snap-In Dividers and Edges (VT 704, VT 703, VT 706)	83
Carpet Coving Cap (VT 410)	83

▶ TROWELS

Trowel Specs	85
Premium Trowels	86
Economy Trowels	89
Trowel Selector Guide	90

▶ SPECIALTY MOULDINGS

3/4" Tee Moulding (7365)	93
1" Tee Moulding (7395)	93
1/16" Cap (TM 80)	94
1/16" Flat Back Cap (TM 81)	94
1/16" Deep Slot Cap (TM 84)	94
3/32" Cap (TM 83)	94
3/32" Wide Face Cap (TM 82)	94
1/8" Cap (WB 104)	95
3/16" Cap (TM 72)	95
13/32" Cap (7524)	95
5/16" Cap (7358)	95
5/16" Wide Face Cap (7359)	95
1/16" Cap (TM 91)	96
1/16" Cove (TM 92)	96
1/16" Cove (TM 98, TM 90)	96
3/32" Cove (TM 85)	96
25/32" Offset Drill Cove (TM 52)	96

1/16" Divider (TM 94)	97
3/32" Divider (WB 110)	97
5/32" Divider (WB 103)	97
1/4" Division (WB 303)	97
1/16" Outside Corner (TM 93)	98
1/2" Plain Facing (TM 19)	98
3/4" Plain Facing (TM 21)	98
7/8" Plain Facing (TM 23)	98
1 1/16" Plain Facing (TM 25)	99
1 1/4 Plain Facing (TM 24)	99
1 1/4" Price Tag Conventional Moulding (0569)	99
13/16" Insert Oval Tee (0923)	99
13/16" Palisade Insert Tee (7364)	99
Panel Hanger (7389)	100
Slat wall Panel (7584)	100
1/2" x 1/8" Flat bar (1005)	101
3/4" x 1/8" Flat bar (1048)	101
1 x 1/8" Flat bar (1004)	101
1 1/4 x 1/8" Flat bar (1068)	101
1 1/2 x 1/8" Flat bar (1049)	101
1/2" Equal Angle (3141)	102
3/4" Equal Angle (3151)	102
1" Equal Angle (3161)	102
3/4" x 3/8" Angle (1750)	102
3/4" x 1/2" Angle (1225)	102
1" x 1/2" Angle (1033)	102
3/4" Equal Angle (1017)	103
1" Equal Angle (1018)	103
1 1/2" Equal Angle (1022)	103
2" Equal Angle (1137)	103
2 1/8" x 1" Angle (1249)	103
7/16" x 1/4" Channel (1347)	104
13/16" x 1/4" Channel (2223)	104
1/2" x 5/16" Channel (1038)	104
5/16" x 3/8" Channel (1285)	104
5/16" x 1/2" Channel (1362)	104
9/16" x 1/2" Channel (1346)	104
3/4" x 1/2" Channel (1538)	105
23/32" x 5/8" Channel (1345)	105
5/16" x 3/4" Channel (2161)	105
1/2" x 3/4" Channel (1040)	105
3/4" x 3/4" Channel (1710)	105
1" x 3/4" Channel (1041)	105
1" x 3/4" Top Channel (7347)	105

▶ WARRANTY

Warranty, material and maintenance information	107
--	-----

ALUMINUM FINISHES

Etched Aluminum
(EA)(BREA)(MFA)

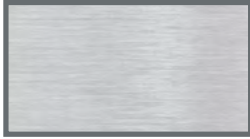

Etched Nickel
(EN)



Etched Bronze
(BRZ)

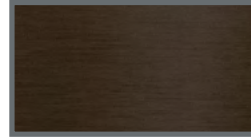

Etched Black
(EBLK)

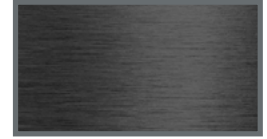

Mill Finish
(MF)

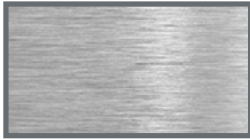

Etched Brass
Mill Finish Brass
(EB, MFB)



Bright Dip Aluminum
(BBDA)



Bright Dip Brass
(BDB)



Buffed Anodized
(BA)

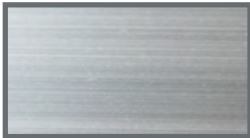

Hammered Etched Anodized
Hammered Mill Finish
(HEA)(HMF)

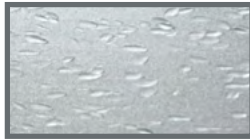

Hammered Nickel
(HN)

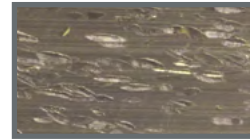

Hammered Bronze
(HBRZ)

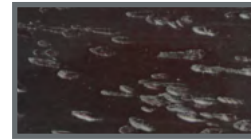

Hammered Black
(HBLK)



Hammered Bright Dip Brass
(HBDB)

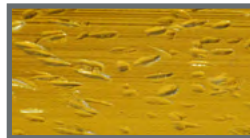

Hammered Brass
(HB)

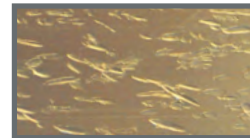

WHITE

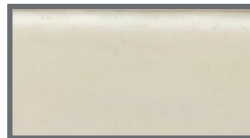

PERGAMON

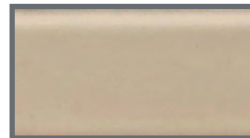

GREY

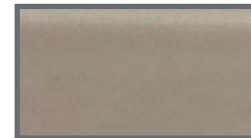

CHERRY

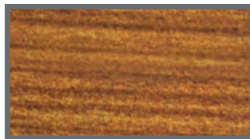

OAK

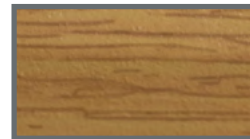

GUNSTOCK



Coventry Gold
(CVG)

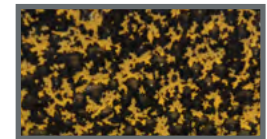

NEW PRODUCTS

Black Finishes

LVT

LVT 130 3mm LVT to Carpet Tile

FINISH: EA, EN, BRZ, EBLK
PAGE: 52

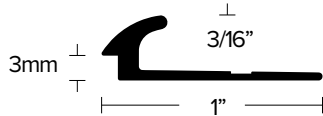

LVT 160 Carpet Tile to LVT/Nothing

FINISH: EA, EN, BRZ, EBLK
PAGE: 53

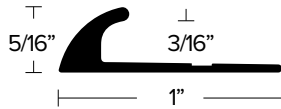

LVT 150 5mm LVT to Carpet Tile

FINISH: EA, EN, BRZ, EBLK
PAGE: 52

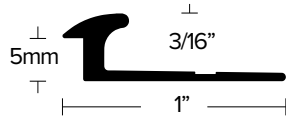

LVT 905 5mm Square Cap

FINISH: EA, EN, BRZ, EBLK
PAGE: 62

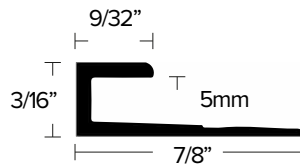

LVT Nosings 2.5mm, 5mm, 12mm

FINISH: EA, EN, BRZ, EBLK (EB in 5mm)
PAGES: 58, 59, 60

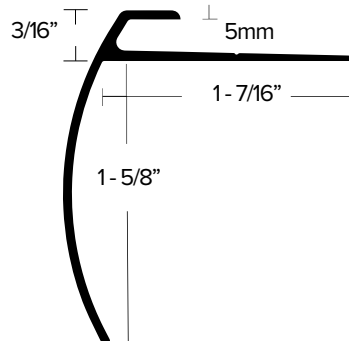

Safety

Carpet Tile Reducers (2mm, 3mm, Bare)

FINISH: EA, EN, BRZ, EBLK
PAGE: 43

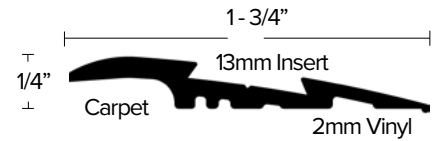

Carpet Tile Joiner 5mm LVT to Carpet Tile

FINISH: EA, EN, BRZ, EBLK
PAGE: 43

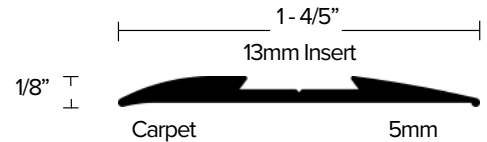

Carpet Tile Joiner Carpet Tile to Carpet Tile

FINISH: EA, EN, BRZ, EBLK
PAGE: 42

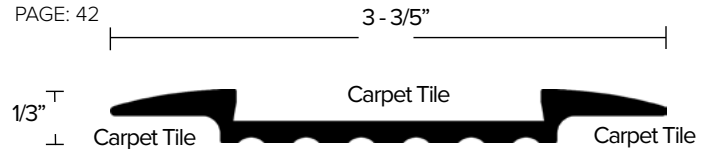

Ceramic

Edgetek™ L Shapes (5/16" and 3/8" Tile)

FINISH: EA, EN, BRZ, EBLK, MF (EB in 3/8")
PAGE: 69

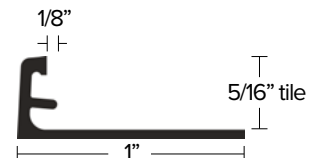

L Shape 1/2" Tile

FINISH: EA, EN, EB, BRZ, EBLK
PAGE: 70

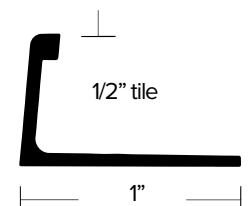

Carpet

CM 100 5/8" Premium Pin Clampdown

FINISH: HMF, HB, HBLK
PAGE: 16

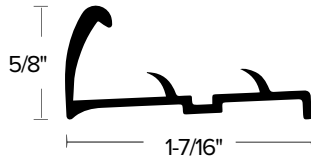

CM 201 1/2" Premium Pinless Clampdown

FINISH: HMF, HB, HEA, HN, HBDB, CVG, HBRZ, HBLK
PAGE: 18



CM 104 1/2" Standard Pin Clampdown

FINISH: HMF, HB, HEA, HN, HBRZ, HBLK
PAGE: 15

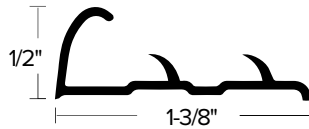

CM 312 1 - 1/2" Standard Binder Bar

FINISH: HMF, HB, HEA, HN, HBDB, HBRZ, HBLK, EBLK, OAK, CHERRY, GUNSTOCK, CVG
PAGE: 23

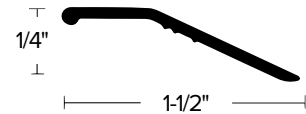

CM 611 1" Standard Stair Nosing

FINISH: HMF, HB, HEA, HN, HBDB, HBRZ, HBLK, CVG
PAGE: 27

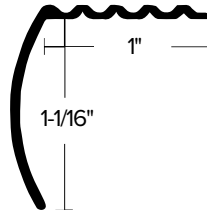

CM 313 1" Standard Binder Bar

FINISH: HMF, HB, HEA, HN, HBDB, HBRZ, HBLK, CVG
PAGE: 22

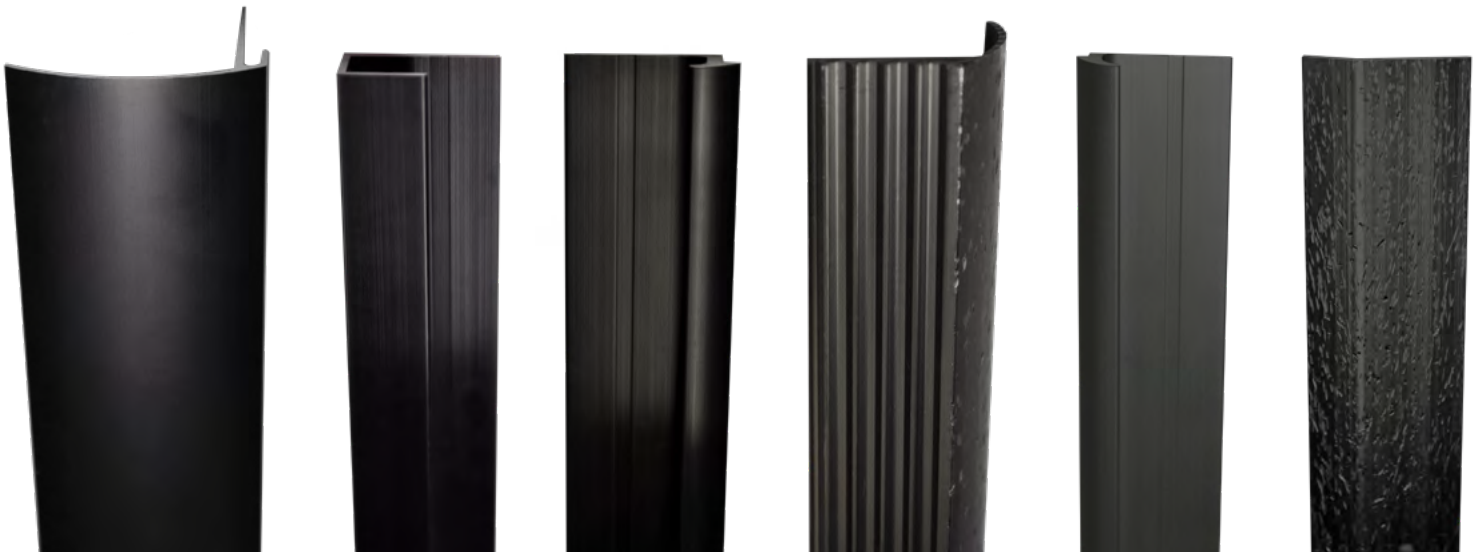
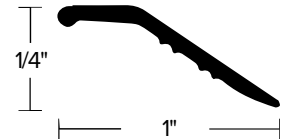

NEW PRODUCTS

SAFETY TRIMS

SAFETY STAIR NOSE

AA351 Ceramic Stair Nose

FINISH: EA
PAGE: 40

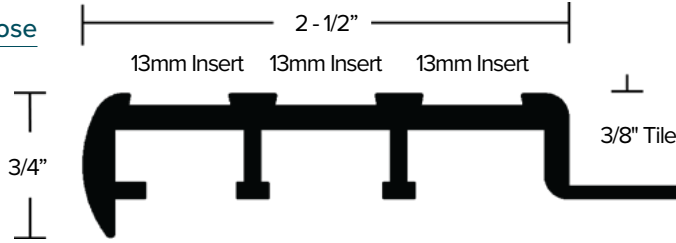

SAFETY TRANSITION

DT024 Caprpet to Vinyl

FINISH: EA, EN, BRZ, EBLK
PAGE: 43

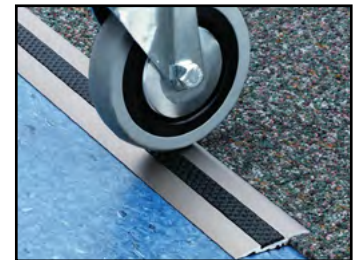
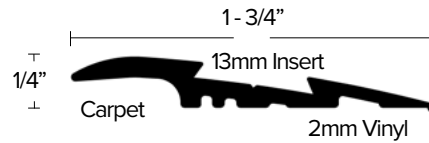

DT027 Caprpet to 3mm LVT

FINISH: EA, EN, BRZ, EBLK
PAGE: 43

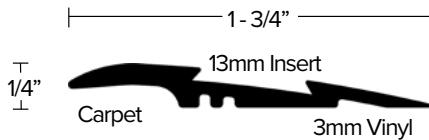

DT028 Caprpet to Bare Floor

FINISH: EA, EN, BRZ, EBLK
PAGE: 43

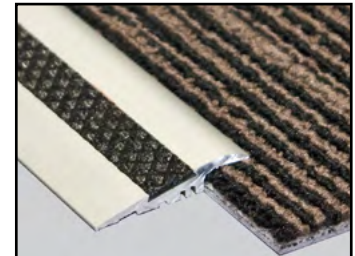
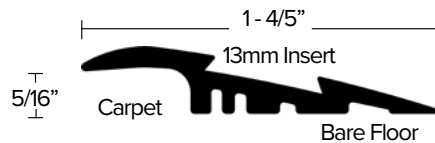

DT029 Caprpet to 5mm LVT

FINISH: EA, EN, BRZ, EBLK
PAGE: 43

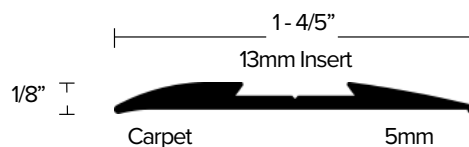

SAFETY TRIMS

SAFETY JOINER

DT026

Joiner

FINISH: EA, EN, BRZ, EBLK
PAGE: 42

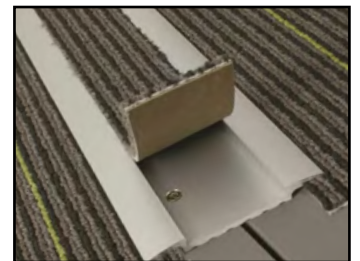
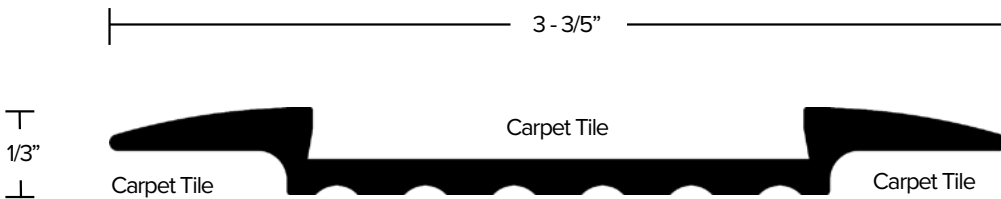

DT025

Joiner

FINISH: EA, EN, BRZ
PAGE: 42

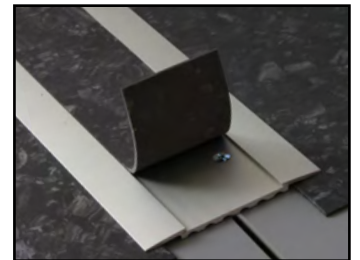
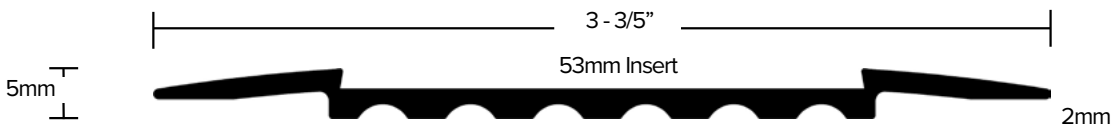

Tredsafe® Inserts

COLOR: Natural Black, Safety Orange, Signal Yellow
SIZE: 13, 43 and 53mm
PAGE: 44

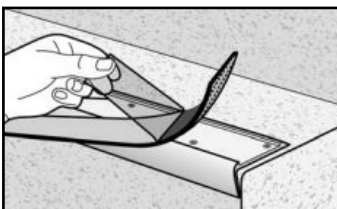

Neutral Black



Signal Yellow



Safety Orange

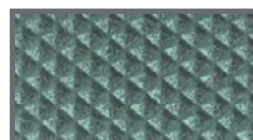

Mid Grey



Rich Brown

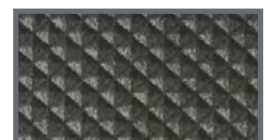

Charcoal

NEW PRODUCTS

LVT TRIMS & TRANSITIONS

LVT REDUCERS

LVT 118 2mm to 5mm No-Lip Ramp

FINISH: MF
PAGE: 49

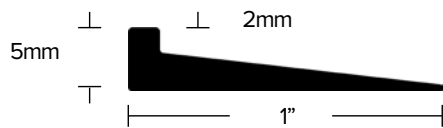

LVT 303 3mm Reducer

FINISH: EA, EN, BRZ, BREA
PAGE: 66



SURFACES OF EQUAL HEIGHT

SEAM BINDER

CM 714 4" Seam Binder

FINISH: EA, EN, BRZ
PAGE: 26



SHEET VINYL

COVE STICK FOR SHEET VINYL

VT 051 1 - 1/4"

PVC
PAGE: 79

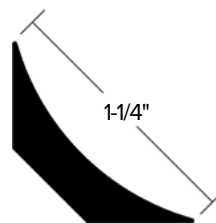

VT 052 1 - 1/2"

PVC
PAGE: 79

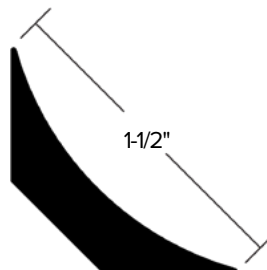

CARPET METAL TRIMS & TRANSITIONS

 Designer trims made to protect and enhance your flooring investment. Made with and without pins or "teeth" for easy installation.



CLAMPDOWN WITH PINS



- Durable clampdown allows protection to carpet edge in areas of high traffic.
- Sharp pins provide strong, long lasting grip on carpets.

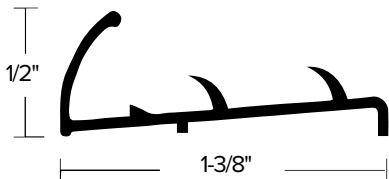

1/2" STANDARD PIN CLAMPDOWN						
ITEM	ITEM DESCRIPTION	NAILS INCL.	LENGTH	QTY	WEIGHT	
031638	CM 3703 HMF 48lb	NO	12'	40	52	
031646	CM 3703 HB 48lb	NO	12'	40	52	
031653	CM 3703 HEA	NO	12'	40	52	
401200	CM 3703 HN	NO	12'	40	52	
031745	CM 3703 HMF-FLEX	NO	12'	12	17	
031752	CM 3703 HB-FLEX	NO	12'	12	17	
406132	CM 3703 HN-FLEX	NO	12'	12	17	

▶ Punched for nails on 6" centers

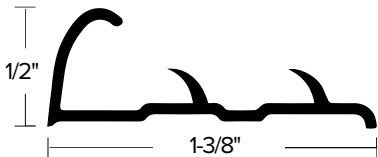

1/2" STANDARD PIN CLAMPDOWN						
ITEM	ITEM DESCRIPTION	NAILS INCL.	LENGTH	QTY	WEIGHT	
401127	CM 104 HMF 48lb	NO	12'	40	53	
401128	CM 104 HB 48lb	NO	12'	40	53	
401126	CM 104 HEA	NO	12'	40	53	
401199	CM 104 HN 48lb	NO	12'	40	53	
390162	CM 104 HBRZ	NO	12'	24	34	
402303	CM 104 HBLK	NO	12'	24	34	

▶ Punched for nails on 6" centers

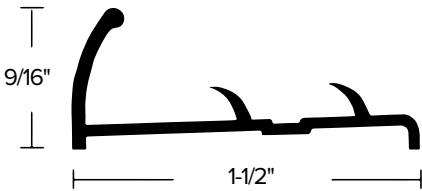

9/16" STANDARD PIN CLAMPDOWN						
ITEM	ITEM DESCRIPTION	NAILS INCL.	LENGTH	QTY	WEIGHT	
401060	CM 95 HMF 48lb	NO	12'	40	61	
401061	CM 95 HB 48lb	NO	12'	40	61	

▶ Punched for nails on 6" centers

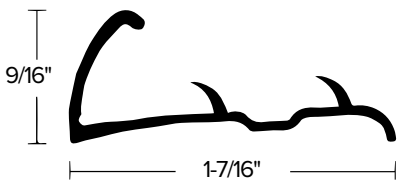

9/16" STANDARD PIN CLAMPDOWN						
ITEM	ITEM DESCRIPTION	NAILS INCL.	LENGTH	QTY	WEIGHT	
401147	CM 12-2114 HMF 48lb	NO	12'	40	61	
021217	CM 12-2114 HMF (CARTON) 48lb	NO	12'	40	61	
401148	CM 12-2117 HB 48lb	NO	12'	40	61	
401201	CM 12-2118 HN	NO	12'	40	61	
401149	CM 12-2114 HMF-FLEX	NO	12'	12	19	
401155	CM 12-2117 HB-FLEX	NO	12'	12	19	

▶ Punched for nails on 6" centers

1/2" PREMIUM PIN CLAMPDOWN

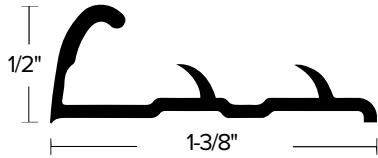

ITEM	ITEM DESCRIPTION	NAILS INCL.	LENGTH	QTY	WEIGHT
401108	CM 102 HMF 48^{lb}	NO	12'	40	66
401109	CM 102 HB 48^{lb}	NO	12'	40	66
401202	CM 102 HN 48^{lb}	NO	12'	40	66
401145	CM 106 HMF-FLEX 48^{lb}	NO	12'	12	21
401146	CM 106 HB-FLEX 48^{lb}	NO	12'	12	21
401168	CM 106 HN-FLEX 48^{lb}	NO	12'	12	21

▶ Punched for nails on 6" centers

9/16" PREMIUM PIN CLAMPDOWN

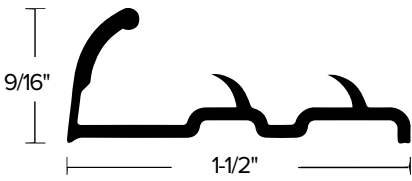

ITEM	ITEM DESCRIPTION	NAILS INCL.	LENGTH	QTY	WEIGHT
401105	CM 101 HMF 48^{lb}	NO	12'	40	75
401106	CM 101 HB 48^{lb}	NO	12'	40	75
401203	CM 101 HN 48^{lb}	NO	12'	40	75
401132	CM 105 HMF-FLEX	NO	12'	12	24
401133	CM 105 HB-FLEX	NO	12'	12	24

▶ Punched for nails on 6" centers

9/16" PREMIUM PIN CLAMPDOWN

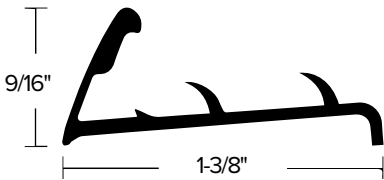

ITEM	ITEM DESCRIPTION	NAILS INCL.	LENGTH	QTY	WEIGHT
031992	CM 3705 HMF 48^{lb}	NO	12'	40	69
032032	CM 3705 HB 48^{lb}	NO	12'	40	69

▶ Punched for nails on 6" centers

5/8" PREMIUM PIN CLAMPDOWN

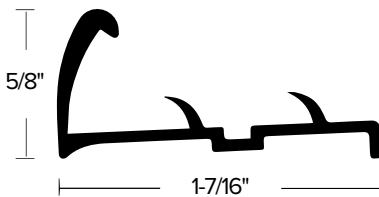

ITEM	ITEM DESCRIPTION	NAILS INCL.	LENGTH	QTY	WEIGHT
401083	CM 100 HMF 48^{lb}	NO	12'	40	80
401084	CM 100 HB 48^{lb}	NO	12'	40	80
402304	CM 100 HBLK	NO	12'	24	46
401080	CM 109 HMF-FLEX	NO	12'	12	27
401081	CM 109 HB-FLEX	NO	12'	12	27

▶ Punched for nails on 6" centers

11/16" PREMIUM PIN CLAMPDOWN

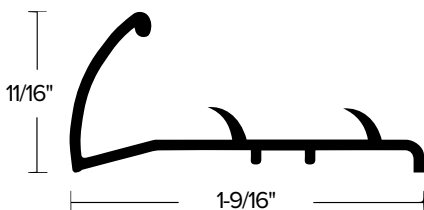

ITEM	ITEM DESCRIPTION	NAILS INCL.	LENGTH	QTY	WEIGHT
031104	CM 3704 HMF 48^{lb}	NO	12'	40	69
031161	CM 3704 HB 48^{lb}	NO	12'	40	69
401204	CM 3704 HN 48^{lb}	NO	12'	40	69
031179	CM 3704 HBDB 48^{lb}	NO	12'	40	69

▶ Punched for nails on 6" centers

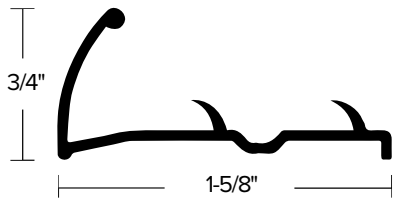

3/4" PREMIUM PIN CLAMPDOWN

ITEM	ITEM DESCRIPTION	NAILS INCL.	LENGTH	QTY	WEIGHT
401070	CM 99A HMF 48^{lbs}	NO	12'	40	71
401071	CM 99A HB 48^{lbs}	NO	12'	40	71
401205	CM 99A HN	NO	12'	40	71
401086	CM 99A CVG	NO	12'	24	44
390166	CM 99A HBRZ	NO	12'	24	44
401052	CM 107A HMF-FLEX	NO	12'	12	22
401053	CM 107A HB-FLEX	NO	12'	12	22
401057	CM 107A HN-FLEX	NO	12'	12	22
401059	CM 107A HBRZ-FLEX	NO	12'	12	22

► Punched for nails on 6" centers

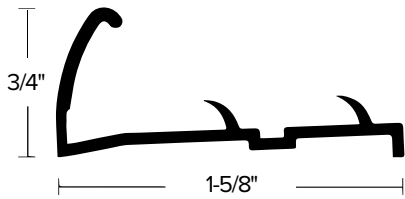

3/4" DELUXE PIN CLAMPDOWN

ITEM	ITEM DESCRIPTION	NAILS INCL.	LENGTH	QTY	WEIGHT
401074	CM 99 HMF 48^{lbs}	NO	12'	40	89
401075	CM 99 HB 48^{lbs}	NO	12'	40	89
401093	CM 99 HBDB	NO	12'	12	29
401077	CM 107 HMF-FLEX	NO	12'	12	27
401078	CM 107 HB-FLEX	NO	12'	12	27
401094	CM 107 HBDB-FLEX	NO	12'	12	27

► Punched for nails on 6" centers

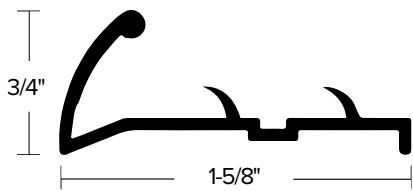

3/4" DELUXE PIN CLAMPDOWN

ITEM	ITEM DESCRIPTION	NAILS INCL.	LENGTH	QTY	WEIGHT
409920	CM 654 HMF 48^{lbs}	NO	12'	40	89
409925	CM 654 HMF	NO	12'	24	55
409921	CM 654 HB 48^{lbs}	NO	12'	40	89
409926	CM 654 HB	NO	12'	24	55
401206	CM 654 HN 48^{lbs}	NO	12'	40	89
409927	CM 654 HBDB	NO	12'	24	55
401098	CM 654 HMF-FLEX	NO	12'	12	26

► Punched for nails on 6" centers

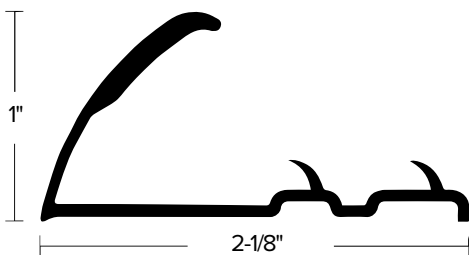

1" COMMERCIAL PIN CLAMPDOWN

ITEM	ITEM DESCRIPTION	NAILS INCL.	LENGTH	QTY	WEIGHT
401118	CM 103 HMF	NO	12'	12	44
401119	CM 103 HB	NO	12'	12	44

► Punched for nails on 6" centers



PINLESS CLAMPDOWNS

- Pinless material made for glue down carpets

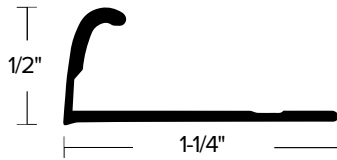

1/2" PREMIUM PINLESS CLAMPDOWN

ITEM	ITEM DESCRIPTION	NAILS INCL.	LENGTH	QTY	WEIGHT
402106	CM 201 HMF <i>48hr</i>	NO	12'	40	52
402108	CM 201 HB <i>48hr</i>	NO	12'	40	52
402109	CM 201 HEA	NO	12'	40	52
401207	CM 201 HN <i>48hr</i>	NO	12'	40	52
402116	CM 201 HBDB	NO	12'	24	33
402302	CM 201 HBLK	NO	12'	24	33
402105	CM 201 CVG	NO	12'	24	33
390167	CM 201 HBRZ	NO	12'	24	33
401325	CM 205 HMF-FLEX	NO	12'	12	16
401326	CM 205 HB -FLEX	NO	12'	12	16
402122	CM 205 HN-FLEX	NO	12'	12	16

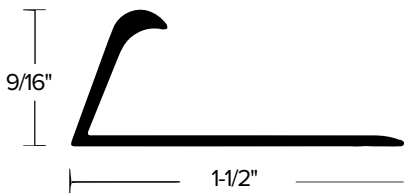

9/16" DELUXE PINLESS CLAMPDOWN

ITEM	ITEM DESCRIPTION	NAILS INCL.	LENGTH	QTY	WEIGHT
402150	CM 211 HMF	NO	12'	40	61
402153	CM 211 HMF	NO	12'	12	20
401352	CM 211 HB	NO	12'	12	20
402149	CM 211 HMF-FLEX	NO	12'	12	18

► No fabrication, nail starter lines

BLANK CLAMPDOWN FOR TACK STRIP

- Blank bar allows for a tack strip to be glued down on top of metal.
- Durable clampdown allows protection to carpet edge in areas of high traffic.

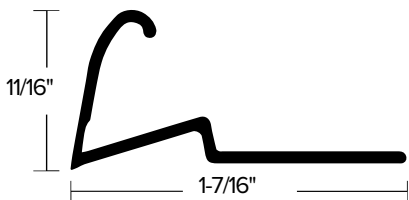

11/16" CLAMPDOWN FOR TACK STRIPS						
ITEM	ITEM DESCRIPTION	NAILS INCL.	LENGTH	QTY	WEIGHT	
401252	CM 121 HMF 48ⁱⁿ	NO	12'	40	69	
401253	CM 121 HB 48ⁱⁿ	NO	12'	40	69	
401208	CM 121 HN	NO	12'	40	69	

JOINER BARS

- Joiner bar divides glued or stretched-in carpets to ceramic, laminate, or hardwood floors.

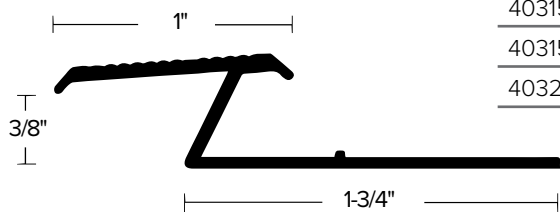

1" CARPET TILE JOINER						
ITEM	ITEM DESCRIPTION	NAILS INCL.	LENGTH	QTY	WEIGHT	
403157	CM 308 MFA	NO	12'	12	35	
403158	CM 308 MFB	NO	12'	12	35	
403228	CM 308 EN	NO	12'	12	35	

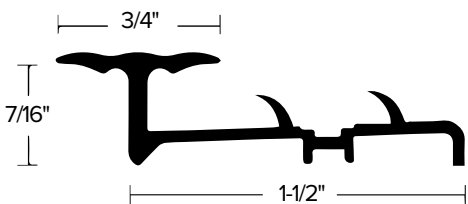

3/4" PALISADE JOINER WITH PINS						
ITEM	ITEM DESCRIPTION	NAILS INCL.	LENGTH	QTY	WEIGHT	
401150	CM 108 HMF	NO	12'	12	33	
401151	CM 108 HB	NO	12'	12	33	
401154	CM 108 HEA	NO	12'	12	33	
401169	CM 108 HN	NO	12'	12	33	

► Punched for nails on 6" centers

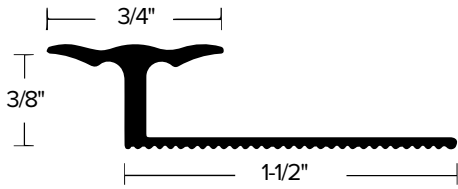

3/4" PALISADE PINLESS JOINER

ITEM	ITEM DESCRIPTION	NAILS INCL.	LENGTH	QTY	WEIGHT
402135	CM 208 HMF	NO	12'	12	26
401170	CM 208 HN	NO	12'	12	26

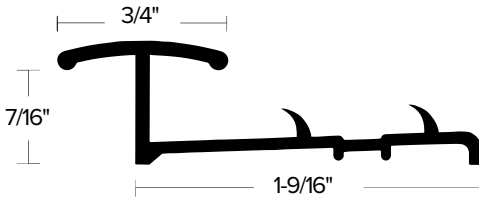

3/4" JOINER WITH PINS

ITEM	ITEM DESCRIPTION	NAILS INCL.	LENGTH	QTY	WEIGHT
406134	CM 112 HEA	NO	12'	12	32
401186	CM 112 HN	NO	12'	12	32

► Punched for nails on 6" centers

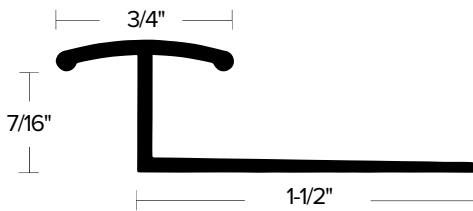

3/4" PINLESS JOINER

ITEM	ITEM DESCRIPTION	NAILS INCL.	LENGTH	QTY	WEIGHT
406133	CM 212 HEA	NO	12'	12	28
401189	CM 212 HN	NO	12'	12	28



INSERT METAL WITH PINS

- Allows for transition between action backed carpet and other flooring types.
- For use with vinyl insert.

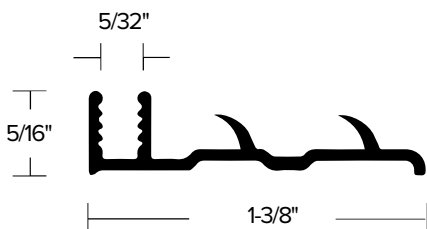

5/16" VINYL INSERT CARPET METAL WITH PINS

ITEM	ITEM DESCRIPTION	NAILS INCL.	LENGTH	QTY	WEIGHT
401159	CM 110 MF 48¢	NO	12'	40	54
401165	CM 110 MF 48¢	NO	12'	20	29
401160	CM 110 MF-FLEX 48¢	NO	12'	12	16

► Punched for nails on 6" centers

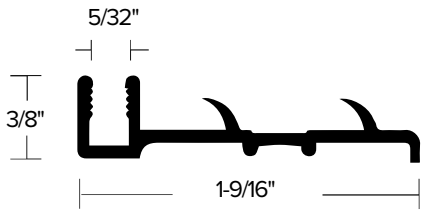

3/8" VINYL INSERT CARPET METAL WITH PINS					
ITEM	ITEM DESCRIPTION	NAILS INCL.	LENGTH	QTY	WEIGHT
032552	CM 3750 MF	NO	12'	20	34

▶ Punched for nails on 6" centers

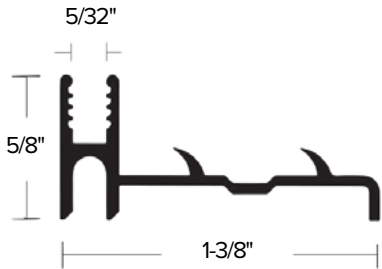

5/8" VINYL INSERT CARPET METAL WITH PINS/EXTENDER					
ITEM	ITEM DESCRIPTION	NAILS INCL.	LENGTH	QTY	WEIGHT
415159	CM 115 MF	NO	12'	12	25

▶ Punched for nails on 6" centers

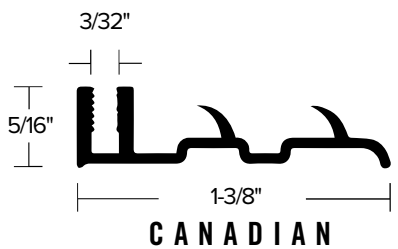

5/16" VINYL INSERT CARPET METAL WITH PINS					
ITEM	ITEM DESCRIPTION	NAILS INCL.	LENGTH	QTY	WEIGHT
402160	CM 310 MF 48^{hrs}	NO	12'	40	65
402159	CM 310 MF-FLEX *	NO	12'	12	19

▶ Canadian Vinyl Insert metal. Punched for Nails, 6" centers

INSERT METAL PINLESS

- Allows for transition between non action backed carpet and other flooring types.
- For use with vinyl insert.

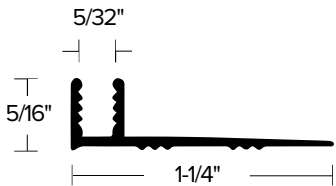

5/16" VINYL INSERT PINLESS CARPET METAL					
ITEM	ITEM DESCRIPTION	NAILS INCL.	LENGTH	QTY	WEIGHT
401158	CM 210 MF	NO	12'	40	49
401166	CM 210 MF	NO	12'	20	26
401157	CM 210 MF-FLEX	NO	12'	12	15

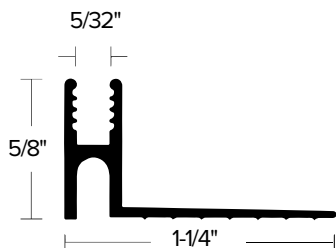

5/8" VINYL INSERT PINLESS / EXTENDER					
ITEM	ITEM DESCRIPTION	NAILS INCL.	LENGTH	QTY	WEIGHT
415160	CM 215 MF	NO	12'	12	23

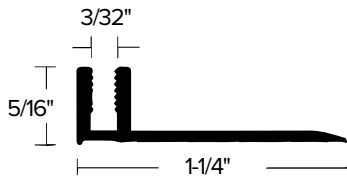

5/16" VINYL INSERT PINLESS CARPET METAL

ITEM	ITEM DESCRIPTION	NAILS INCL.	LENGTH	QTY	WEIGHT
402161	CM 410 MF 48^{lbs}	NO	12'	40	59
402163	CM 410 MF-FLEX	NO	12'	12	17

▶ Canadian Vinyl Insert metal

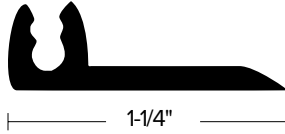

VINYL SINGLE FLANGE TRACK

ITEM	ITEM DESCRIPTION	LENGTH	QTY	WEIGHT
460530	VT 253 WHITE	12'	20	20



FLAT BAR

- Flat bar transitions between two surfaces of different height.

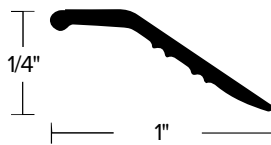

1" STANDARD BINDER BAR

ITEM	ITEM DESCRIPTION	NAILS INCL.	LENGTH	QTY	WEIGHT
403170	CM 313 HMF 48^{lbs}	NO	12'	40	34
403181	CM 313 HMF 48^{lbs}	YES	12'	40	37
403219	CM 313 HMF 48^{lbs}	YES	12'	12	14
403171	CM 313 HB 48^{lbs}	NO	12'	40	34
403180	CM 313 HB 48^{lbs}	YES	12'	40	37
403211	CM 313 HB 48^{lbs}	YES	12'	12	14
403169	CM 313 HEA	NO	12'	40	34
404107	CM 313 HN	YES	12'	12	14
401209	CM 313 HN 48^{lbs}	YES	12'	40	37
402132	CM 313 HBDB	YES	12'	24	24
403212	CM 313 HBDB	YES	12'	12	14
390437	CM 313 CVG	YES	12'	24	24
390165	CM 313 HBRZ	YES	12'	24	24
402306	CM 313 HBLK	YES	12'	24	24

▶ Drilled and countersunk, 6" centers for #3 fastener



1" DELUXE BINDER BAR

ITEM	ITEM DESCRIPTION	NAILS INCL.	LENGTH	QTY	WEIGHT
403121	CM 303 HMF 48^{lbs}	NO	12'	40	45
403122	CM 303 HB 48^{lbs}	NO	12'	40	45
401210	CM 303 HN 48^{lbs}	YES	12'	40	48

▶ Drilled and countersunk, 6" centers for #3 fastener

1 - 1/2" STANDARD BINDER BAR

ITEM	ITEM DESCRIPTION	NAILS INCL.	LENGTH	QTY	WEIGHT
403160	CM 312 HMF 48^{lbs}	NO	12'	40	56
390432	CM 312 HMF 48^{lbs}	YES	12'	40	58
390456	CM 312 HMF	YES	12'	24	36
403161	CM 312 HB 48^{lbs}	NO	12'	40	56
390431	CM 312 HB 48^{lbs}	YES	12'	40	58
390455	CM 312 HB	YES	12'	24	36
403159	CM 312 HEA	NO	12'	40	56
401211	CM 312 HN 48^{lbs}	YES	12'	40	58
390435	CM 312 HBDB 48^{lbs}	YES	12'	40	58
402129	CM 312 HBDB	YES	12'	24	36
390436	CM 312 CVG 48^{lbs}	YES	12'	24	36
390163	CM 312 HBRZ	YES	12'	24	36
402305	CM312 HBLK	YES	12'	24	36
403257	CM 312 OAK	YES	12'	24	36
403258	CM 312 CHERRY	YES	12'	24	36
403259	CM 312 GUNSTOCK	YES	12'	24	36
402254	CM 312 EBLK	YES	12'	24	36

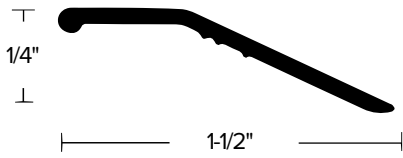

► Drilled and countersunk, 6" centers for #3 fastener

1 - 1/2" PREMIUM BINDER BAR

ITEM	ITEM DESCRIPTION	NAILS INCL.	LENGTH	QTY	WEIGHT
403111	CM 302 HMF 48^{lbs}	NO	12'	40	59
403117	CM 302 HMF	YES	12'	40	61
403112	CM 302 HB 48^{lbs}	NO	12'	40	59
401212	CM 302 HN 48^{lbs}	YES	12'	40	61
403118	CM 302 HBDB	YES	12'	40	61

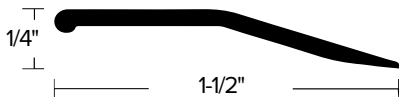

► Drilled and countersunk, 6" centers for #3 fastener

2" DELUXE BINDER BAR

ITEM	ITEM DESCRIPTION	NAILS INCL.	LENGTH	QTY	WEIGHT
403140	CM 304 HMF 48^{lbs}	NO	12'	12	35
403182	CM 304 HMF 48^{lbs}	YES	12'	12	35
403141	CM 304 HB 48^{lbs}	NO	12'	12	35
403183	CM 304 HB 48^{lbs}	YES	12'	12	35
401102	CM 304 HEA	NO	12'	12	35
403231	CM 304 HN	YES	12'	12	35
403142	CM 304 HBDB	YES	12'	12	35

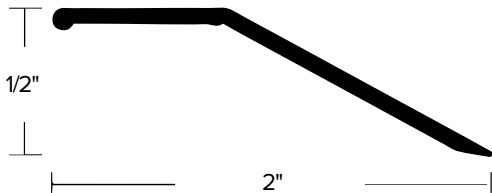

► Drilled and countersunk, 6" centers for #3 fastener

2 - 1/2" DELUXE BINDER BAR

ITEM	ITEM DESCRIPTION	NAILS INCL.	LENGTH	QTY	WEIGHT
403305	CM 315 HMF	YES	12'	12	54
403306	CM 315 HB	NO	12'	12	54

▶ Drilled and countersunk, 6" centers for #3 fastener

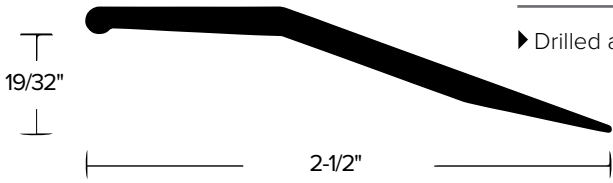

2 - 1/2" DELUXE BINDER BAR

ITEM	ITEM DESCRIPTION	NAILS INCL.	LENGTH	QTY	WEIGHT
390321	CM 305 HMF	NO	12'	12	62
390322	CM 305 HB	NO	12'	12	62

▶ Drilled and countersunk, 6" centers for #8 fastener

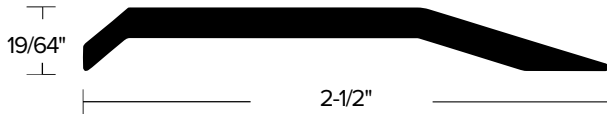

3/4" BINDER BAR-OVERLAPPING

ITEM	ITEM DESCRIPTION	NAILS INCL.	LENGTH	QTY	WEIGHT
407101	CM 701 HMF	NO	12'	40	34
403205	CM 701 HMF	YES	12'	40	37
403216	CM 701 HMF	YES	12'	12	14
401351	CM 701 HB	YES	12'	12	14

▶ Drilled and countersunk, 6" centers for #3 fastener

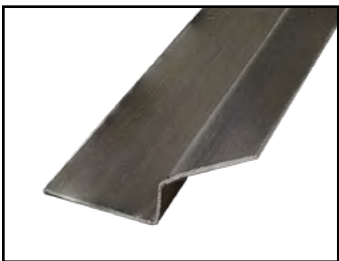
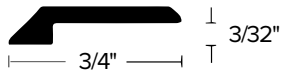

Z BAR

- Creates a finished edge for stretch-in carpet to hard flooring transitions.

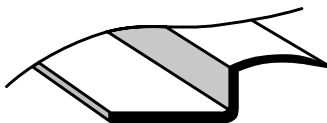

Z-BAR

ITEM	ITEM DESCRIPTION	NAILS INCL.	LENGTH	QTY	WEIGHT
404150	CM 501 MF	NO	4.0	25	5

SEAM BINDER

- Seam binder transitions between two surfaces with large gap or equal height.

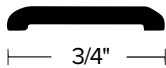
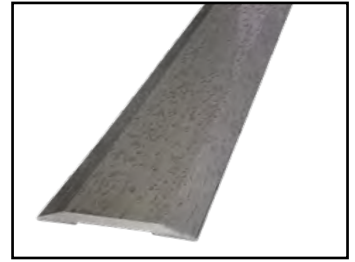

3/4" SEAM BINDER

ITEM	ITEM DESCRIPTION	NAILS INCL.	LENGTH	QTY	WEIGHT
407115	CM 702 HMF	NO	12'	40	39
403201	CM 702 HMF	YES	12'	40	42
407120	CM 702 HB	NO	12'	40	39
407121	CM 702 HEA	NO	12'	40	39
401215	CM 702 HN	YES	12'	40	42

▶ Drilled and countersunk, 6" centers for #3 fastener

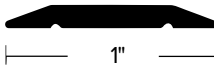

1" SEAM BINDER

ITEM	ITEM DESCRIPTION	NAILS INCL.	LENGTH	QTY	WEIGHT
401193	CM 705 HEA	NO	12'	40	52
401192	CM 705 HB	NO	12'	40	52
401216	CM 705 HN	NO	12'	40	52

▶ Drilled and countersunk, 6" centers for #3 fastener

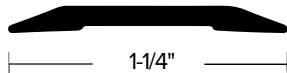

1 - 1/4" SEAM BINDER

ITEM	ITEM DESCRIPTION	NAILS INCL.	LENGTH	QTY	WEIGHT
407135	CM 703 HMF	NO	12'	40	57
403203	CM 703 HMF	YES	12'	40	59
407140	CM 703 HB	NO	12'	40	57
403204	CM 703 HB	YES	12'	40	59
401103	CM 703 HEA	NO	12'	40	57
401217	CM 703 HN	YES	12'	40	59

▶ Drilled and countersunk, 6" centers for #3 fastener

2 - 1/2" SEAM BINDER

ITEM	ITEM DESCRIPTION	NAILS INCL.	LENGTH	QTY	WEIGHT
031018	CM 704 HMF	YES	12'	12	63
570048	CM 704 MFA	NO	12'	12	63
031042	CM 704 HB	YES	12'	12	63

▶ Drilled and countersunk, 6" centers for #8 fastener

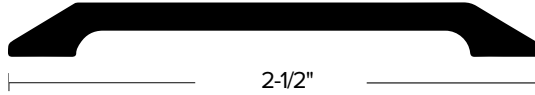

4" SEAM BINDER

ITEM	ITEM DESCRIPTION	NAILS INCL.	LENGTH	QTY	WEIGHT
402275	CM 714 EA	NO	12'	12	90
402276	CM 714 EN	NO	12'	12	90
402277	CM 714 BRZ	NO	12'	12	90

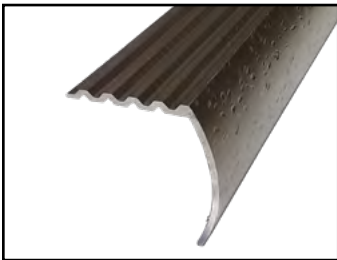
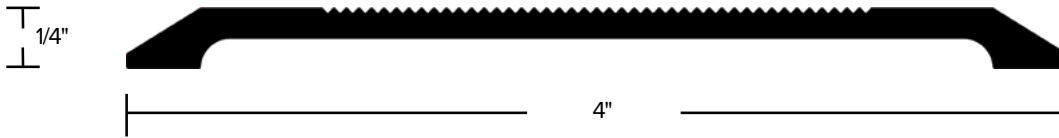

STAIR NOSING

- The durable stair nosing protects the edge of the stair from damage.
- Multiple drops and landing sizes available.

1 - 1/16" DELUXE STAIR NOSING

ITEM	ITEM DESCRIPTION	NAILS INCL.	LENGTH	QTY	WEIGHT
406102	CM 601 HMF 48^{lbs}	NO	12'	40	81
406130	CM 601 HMF 48^{lbs}	YES	12'	40	83
406103	CM 601 HB 48^{lbs}	NO	12'	40	81
406131	CM 601 HB 48^{lbs}	YES	12'	40	83
401214	CM 601 HN 48^{lbs}	YES	12'	40	83
406108	CM 601 HBDB	YES	12'	12	27
389135	CM 601 CVG	YES	12'	12	27
401122	CM 601 OAK	YES	12'	24	51
401124	CM 601 GUNSTOCK	YES	12'	24	51

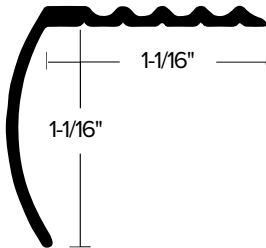

▶ Drilled and countersunk, 6" centers for #3 fastener

1" STANDARD STAIR NOSING

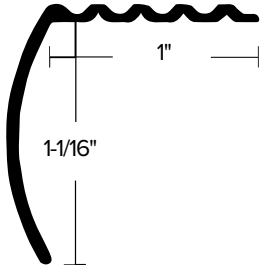

ITEM	ITEM DESCRIPTION	NAILS INCL.	LENGTH	QTY	WEIGHT
406115	CM 611 HMF 48^{hrs}	NO	12'	40	68
403207	CM 611 HMF 48^{hrs}	YES	12'	40	70
403267	CM 611 HMF	YES	12'	24	43
403218	CM 611 HMF 48^{hrs}	YES	12'	12	23
406116	CM 611 HB 48^{hrs}	NO	12'	40	68
403187	CM 611 HB 48^{hrs}	YES	12'	40	70
402124	CM 611 HB	YES	12'	24	43
403214	CM 611 HB 48^{hrs}	YES	12'	12	23
403230	CM 611 HEA	YES	12'	40	70
401213	CM 611 HN 48^{hrs}	YES	12'	40	70
403215	CM 611 HBDB	YES	12'	12	23
390438	CM 611 CVG 48^{hrs}	YES	12'	24	43
390164	CM 611 HBRZ	YES	12'	24	43
402307	CM 611 HBLK	YES	12'	24	43

▶ Drilled and countersunk, 6" centers for #3 fastener

1 - 5/8" DELUXE STAIR NOSING

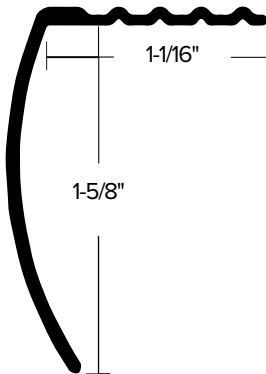

ITEM	ITEM DESCRIPTION	NAILS INCL.	LENGTH	QTY	WEIGHT
406160	CM 605 HMF 48^{hrs}	NO	12'	12	30
403191	CM 605 HMF 48^{hrs}	YES	12'	12	30
406161	CM 605 HB 48^{hrs}	NO	12'	12	30
403192	CM 605 HB 48^{hrs}	YES	12'	12	30
406165	CM 605 HEA	NO	12'	12	30
406159	CM 605 HN 48^{hrs}	YES	12'	12	30
403193	CM 605 HBDB	YES	12'	12	30
403240	CM 605 CVG	YES	12'	12	30
403145	CM 605 HBRZ	YES	12'	12	30

▶ Drilled and countersunk, 6" centers for #3 fastener

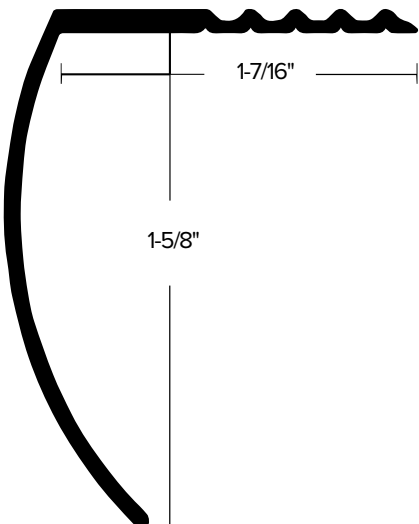

1 - 5/8" STANDARD WIDE TREAD STAIR NOSING

ITEM	ITEM DESCRIPTION	NAILS INCL.	LENGTH	QTY	WEIGHT
406166	CM 615 HMF 48^{hrs}	YES	12'	12	35
406167	CM 615 HB 48^{hrs}	YES	12'	12	35
403232	CM 615 HN	YES	12'	12	35

▶ Drilled and countersunk, 6" centers for #10 fastener

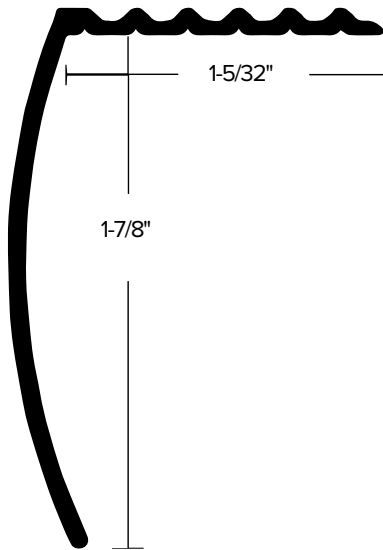

1 - 7/8" DELUXE STAIR NOSING

ITEM	ITEM DESCRIPTION	NAILS INCL.	LENGTH	QTY	WEIGHT
406182	CM 627 HMF	NO	12'	12	38
406184	CM 627 HB	NO	12'	12	38
406183	CM 627 HN	NO	12'	12	38

▶ Drilled and countersunk, 6" centers for #3 fastener

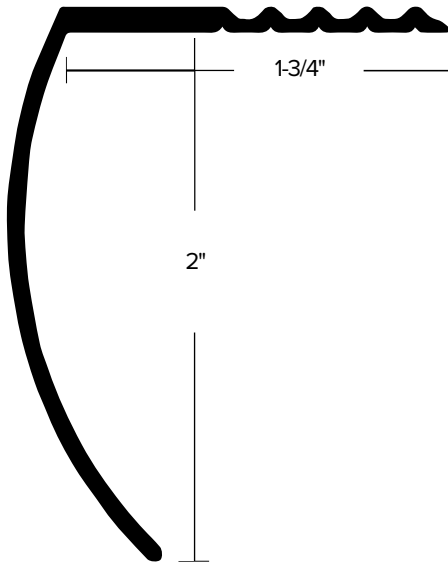

2" STANDARD WIDE TREAD STAIR NOSING

ITEM	ITEM DESCRIPTION	NAILS INCL.	LENGTH	QTY	WEIGHT
406174	CM 617 HMF	NO	12'	12	47
406175	CM 617 HB	NO	12'	12	47

▶ Drilled and countersunk, 6" centers for #3 fastener

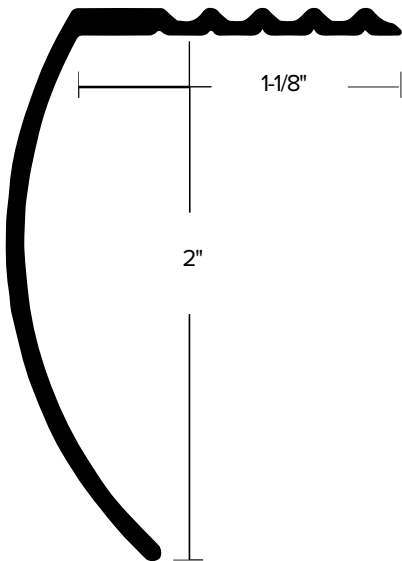

2" DELUXE STAIR NOSING

ITEM	ITEM DESCRIPTION	NAILS INCL.	LENGTH	QTY	WEIGHT
406170	CM 607 HMF	NO	12'	12	41
406171	CM 607 HB	NO	12'	12	41
406176	CM 607 HN	YES	12'	12	42

▶ Drilled and countersunk, 6" centers for #3 fastener

*Illustrations do not represent actual size.

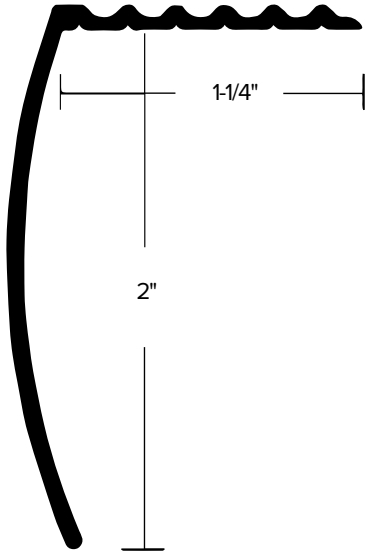

2" DELUXE STAIR NOSING

ITEM	ITEM DESCRIPTION	NAILS INCL.	LENGTH	QTY	WEIGHT
406124	CM 648 HMF	YES	12'	12	37
406126	CM 648 HB	YES	12'	12	37
406127	CM 648 HN	YES	12'	12	37
406125	CM 648 HBDB	YES	12'	12	37

▶ Drilled and countersunk, 6" centers for #3 fastener

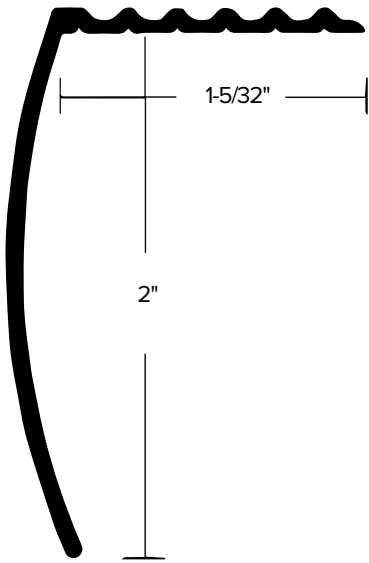

2" DELUXE STAIR NOSING

ITEM	ITEM DESCRIPTION	NAILS INCL.	LENGTH	QTY	WEIGHT
406185	CM 637 HMF	NO	12'	12	39
406186	CM 637 HB	NO	12'	12	39
406189	CM 637 HEA	NO	12'	12	39
406187	CM 637 HN	NO	12'	12	39

▶ Drilled and countersunk, 6" centers for #3 fastener

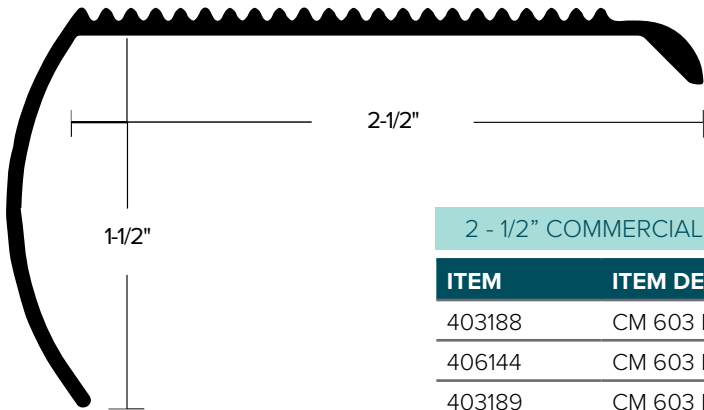

2 - 1/2" COMMERCIAL STAIR NOSING

ITEM	ITEM DESCRIPTION	NAILS INCL.	LENGTH	QTY	WEIGHT
403188	CM 603 EA	YES	12'	12	39
406144	CM 603 BA	YES	12'	12	39
403189	CM 603 EB	YES	12'	12	39
403266	CM 603 EN	YES	12'	12	39

▶ Drilled and countersunk, 6" centers for #3 fastener

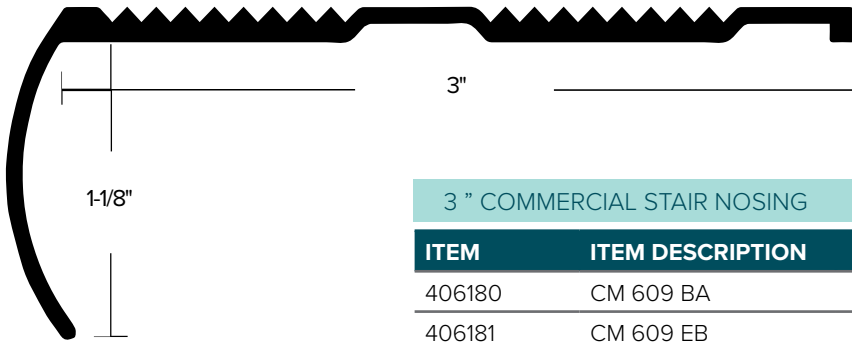

3 " COMMERCIAL STAIR NOSING

ITEM	ITEM DESCRIPTION	NAILS INCL.	LENGTH	QTY	WEIGHT
406180	CM 609 BA	NO	12'	12	62
406181	CM 609 EB	NO	12'	12	62

► Drilled and countersunk for #4 screw, 6" centers

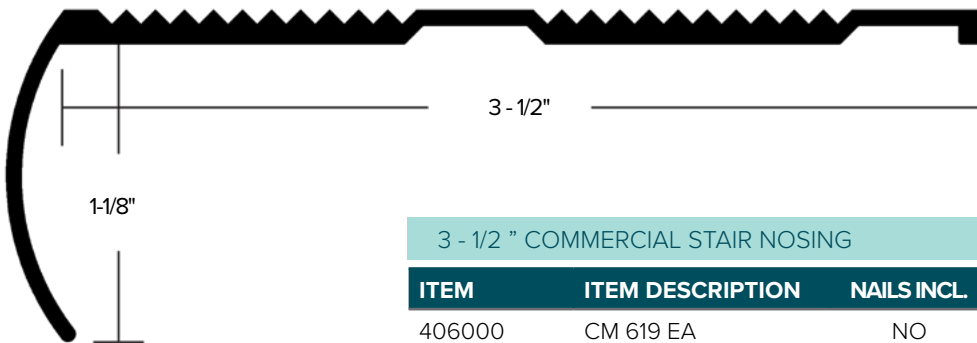

3 - 1/2 " COMMERCIAL STAIR NOSING

ITEM	ITEM DESCRIPTION	NAILS INCL.	LENGTH	QTY	WEIGHT
406000	CM 619 EA	NO	12'	12	68

► Drilled and countersunk for #4 screw, 6" centers

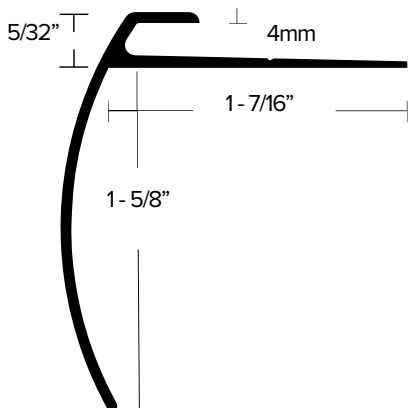

3/32" (4MM) CARPET TILE STAIR NOSING

ITEM	ITEM DESCRIPTION	NAILS INCL.	LENGTH	QTY	WEIGHT
401176	LVT 606 EA	NO	12'	12	37
401177	LVT 606 EN	NO	12'	12	37
401175	LVT 606 BRZ	NO	12'	12	37

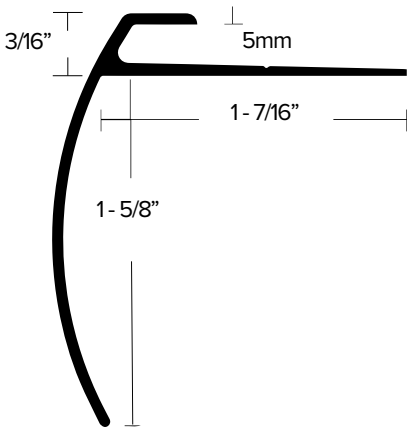

3/16" 5MM CARPET TILE STAIR NOSING					
ITEM	ITEM DESCRIPTION	NAILS INCL.	LENGTH	QTY	WEIGHT
389141	LVT 608 EA	NO	12'	12	37
389143	LVT 608 EN	NO	12'	12	37
390168	LVT 608 BRZ	NO	12'	12	37
402273	LVT 608 EBLK	NO	12'	12	37
389142	LVT 608 EB	NO	12'	12	37

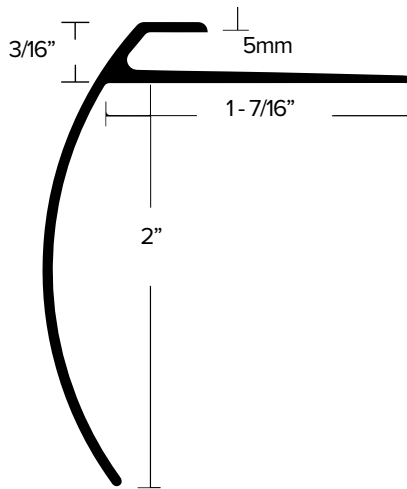

3/16" 5MM CARPET TILE STAIR NOSING (LONG)					
ITEM	ITEM DESCRIPTION	NAILS INCL.	LENGTH	QTY	WEIGHT
401178	LVT 610 EA	NO	12'	12	41
401179	LVT 610 EN	NO	12'	12	41
401180	LVT 610 BRZ	NO	12'	12	41

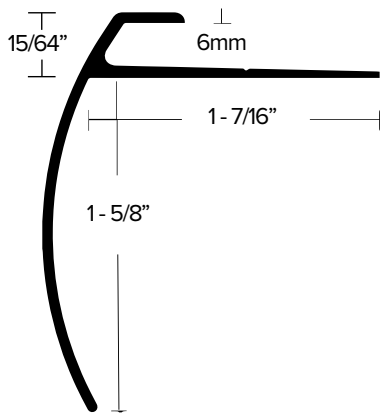

1/4" (6MM) CARPET TILE STAIR NOSING					
ITEM	ITEM DESCRIPTION	NAILS INCL.	LENGTH	QTY	WEIGHT
401197	LVT 604 EA	NO	12'	12	37
401198	LVT 604 EN	NO	12'	12	37
401196	LVT 604 BRZ	NO	12'	12	37

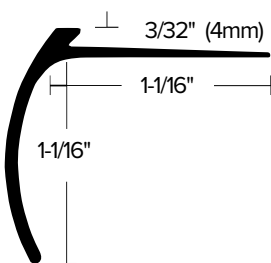

3/32" (4MM) "SCRIBE-TO" STAIR NOSING					
ITEM	ITEM DESCRIPTION	NAILS INCL.	LENGTH	QTY	WEIGHT
406121	CM 602 HMF	NO	12'	40	81

► Drilled and countersunk, 6" centers for #3 fastener

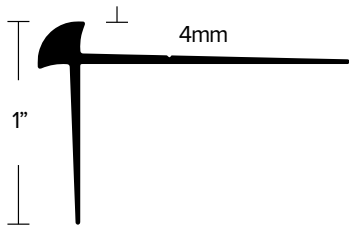

3/32" (4MM) NO-LIP STAIR NOSING

ITEM	ITEM DESCRIPTION	NAILS INCL.	LENGTH	QTY	WEIGHT
402083	LVT 343 EA	NO	12'	12	26
402084	LVT 343 EN	NO	12'	12	26
402085	LVT 343 BRZ	NO	12'	12	26

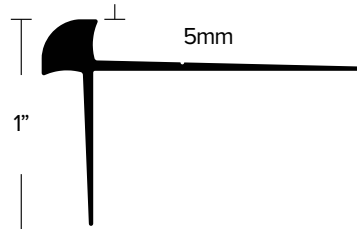

3/16" (5MM) NO-LIP STAIR NOSING

ITEM	ITEM DESCRIPTION	NAILS INCL.	LENGTH	QTY	WEIGHT
402046	LVT 341 EA	NO	12'	12	28
402047	LVT 341 EN	NO	12'	12	28
402048	LVT 341 BRZ	NO	12'	12	28

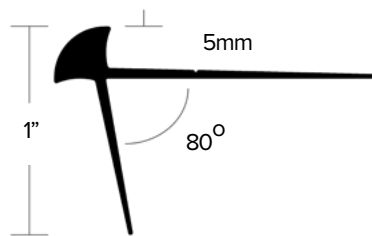

5MM NO-LIP STAIR NOSING 80° ANGLE

ITEM	ITEM DESCRIPTION	NAILS INCL.	LENGTH	QTY	WEIGHT
402220	LVT 347 EA	NO	12'	12	24
402221	LVT 347 EN	NO	12'	12	24
402222	LVT 347 BRZ	NO	12'	12	24

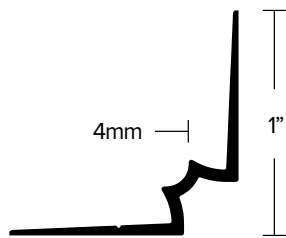

3/32" (4MM) NO-LIP STAIR RISER

ITEM	ITEM DESCRIPTION	NAILS INCL.	LENGTH	QTY	WEIGHT
508735	LVT 333 EA	NO	12'	12	19
508736	LVT 333 EN	NO	12'	12	19
508737	LVT 333 BRZ	NO	12'	12	19

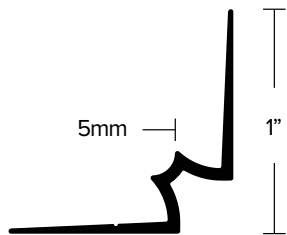

3/16" (5MM) NO-LIP STAIR RISER

ITEM	ITEM DESCRIPTION	NAILS INCL.	LENGTH	QTY	WEIGHT
402014	LVT 331 EA	NO	12'	12	19
402049	LVT 331 EN	NO	12'	12	19
402050	LVT 331 BRZ	NO	12'	12	19

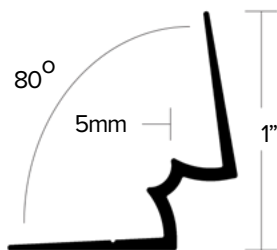

5MM NO-LIP STAIR RISER 80° ANGLE

ITEM	ITEM DESCRIPTION	NAILS INCL.	LENGTH	QTY	WEIGHT
402225	LVT 337 EA	NO	12'	12	19
402224	LVT 337 EN	NO	12'	12	19
402223	LVT 337 BRZ	NO	12'	12	19

DRIVE NAILS

- Drive nails are used to fasten flooring trims to wood floor.
- Some products come with nails included.



COUNTERSUNK OVAL HEAD SCREW NAILS



ITEM	ITEM DESCRIPTION	FINISH	PACK	QTY PER PACK
482066	DRIVE NAIL	CHERRY	24 pack	25
482068	DRIVE NAIL	GUNSTOCK	24 pack	25
482041	DRIVE NAIL	BRASS	40 pack	25
482059	DRIVE NAIL	BLACK	24 pack	25
482036	DRIVE NAIL	BRASS	50 lbs bulk	-
489008	DRIVE NAIL	BRONZE	24 pack	25
482070	DRIVE NAIL	NICKEL	12 pack	25
482074	DRIVE NAIL	NICKEL	40 pack	25
482072	DRIVE NAIL	OAK	24 pack	25
482026	DRIVE NAIL	SILVER	50 lbs bulk	-
482031	DRIVE NAIL	SILVER	40 pack	25
482063	DRIVE NAIL	NICKEL	50 lbs bulk	-
482071	DRIVE NAIL	BLACK	12 pack	25

STRAIGHT EDGE

- Straight edge is a useful tool for installers that acts as a guide to cut carpet to have a straight edge.

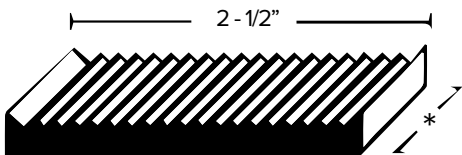
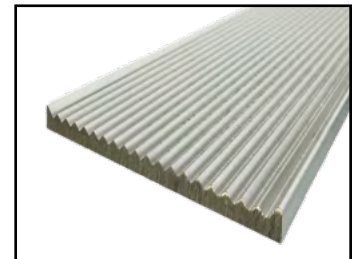

* 36", 75" 2 - 1/2"

2 - 1/2" STRAIGHT EDGE

ITEM	ITEM DESCRIPTION	NAILS INCL.	LENGTH	QTY	WEIGHT
409170	CM 36 EA 48^{lbs}	NO	36"	6	21
409171	CM 75 EA 48^{lbs}	NO	75"	6	40

▶ 45° angle, one end only

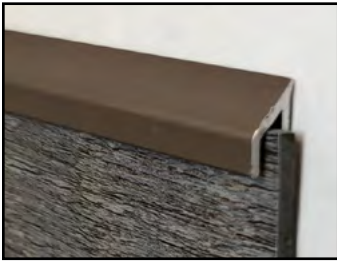

CAPS

- Coving carpet up walls and cap off for a smooth look.

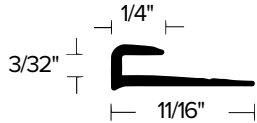

3/32" COVING CAP

ITEM	ITEM DESCRIPTION	NAILS INCL.	LENGTH	QTY	WEIGHT
409155	CM 903 MFA 48^{lbs}	NO	12'	40	26
409165	CM 903 EB	NO	12'	40	26
410817	CM 903 EN	NO	12'	24	17
409154	CM 903 MFA	NO	12'	12	10

▶ Punched and slotted on 2" centers

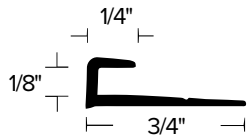

1/8" COVING CAP

ITEM	ITEM DESCRIPTION	NAILS INCL.	LENGTH	QTY	WEIGHT
409110	CM 901 HMF	NO	8'	60	31
409115	CM 901 HMF 48^{lbs}	NO	12'	40	32
409130	CM 901 MFA 48^{lbs}	NO	8'	60	31
409105	CM 901 MFA 48^{lbs}	NO	12'	40	32
409135	CM 901 MFB 48^{lbs}	NO	8'	60	31
530706	CM 901 HN	NO	12'	24	21
409986	CM 901 EN	NO	12'	40	32

▶ Punched and slotted on 2" centers

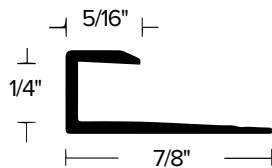

1/4" COVING CAP

ITEM	ITEM DESCRIPTION	NAILS INCL.	LENGTH	QTY	WEIGHT
409956	CM 401 HMF	NO	12'	40	36
409980	CM 401 MFA 48^{lbs}	NO	12'	40	36
404101	CM 401 BA	NO	12'	40	36
409955	CM 401 HB	NO	12'	40	36
409981	CM 401 MFB	NO	12'	40	36
409985	CM 401 EN	NO	12'	40	36

▶ Punched and slotted on 2" centers

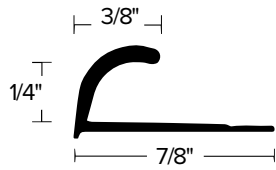

1/4" ROUND COVING CAP

ITEM	ITEM DESCRIPTION	NAILS INCL.	LENGTH	QTY	WEIGHT
404049	CM 400 HMF	NO	12'	40	39

► No fabrication. Nail starter lines

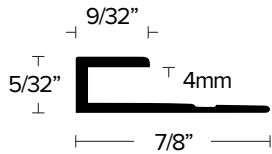

5/32" (4MM) SQUARE CAP

ITEM	ITEM DESCRIPTION	NAILS INCL.	LENGTH	QTY	WEIGHT
403263	LVT 904 EA	NO	12'	24	22
403264	LVT 904 EN	NO	12'	24	22
403265	LVT 904 BRZ	NO	12'	24	22

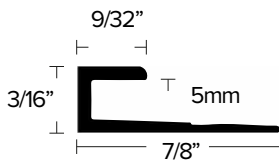

3/16" (5MM) SQUARE CAP

ITEM	ITEM DESCRIPTION	NAILS INCL.	LENGTH	QTY	WEIGHT
403262	LVT 905 EA	NO	12'	24	22
403261	LVT 905 EN	NO	12'	24	22
403260	LVT 905 BRZ	NO	12'	24	22
402267	LVT 905 EBLK	NO	12'	24	22

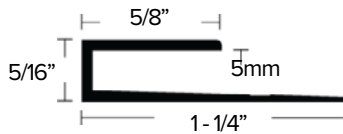

5MM SQUARE CAP EXTENDED LIP

ITEM	ITEM DESCRIPTION	NAILS INCL.	LENGTH	QTY	WEIGHT
402157	LVT 915 EA	NO	12'	24	33
402156	LVT 915 EN	NO	12'	24	33
402155	LVT 915 BRZ	NO	12'	24	33

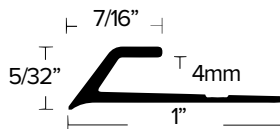

5/32" (4MM) BEVEL CAP

ITEM	ITEM DESCRIPTION	NAILS INCL.	LENGTH	QTY	WEIGHT
390153	LVT 404 EA	NO	12'	24	27
390154	LVT 404 EN	NO	12'	24	27
390155	LVT 404 BRZ	NO	12'	24	27

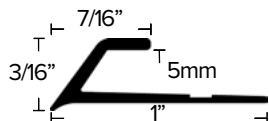

3/16" (5MM) BEVEL CAP

ITEM	ITEM DESCRIPTION	NAILS INCL.	LENGTH	QTY	WEIGHT
390159	LVT 405 EA	NO	12'	24	28
390160	LVT 405 EN	NO	12'	24	28
390161	LVT 405 BRZ	NO	12'	24	28



CARPET TO LVT

- Transitions from carpet tile to LVT of 3 or 5 mm height.
- Transitions from stretch carpet to 9mm flooring

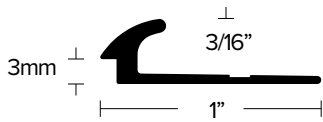

3MM LVT TO CARPET TILE

ITEM	ITEM DESCRIPTION	NAILS INCL.	LENGTH	QTY	WEIGHT
402000	LVT 130 EA	NO	12'	24	31
402001	LVT 130 EN	NO	12'	24	31
402002	LVT 130 BRZ	NO	12'	24	31
402269	LVT 130 EBLK	NO	12'	24	31
510118	LVT 130 EA-FLEX	NO	12'	12	17
510119	LVT 130 EN-FLEX	NO	12'	12	17
510120	LVT 130 BRZ-FLEX	NO	12'	12	17

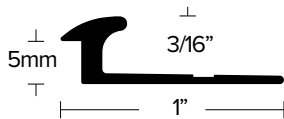

5MM LVT TO CARPET TILE

ITEM	ITEM DESCRIPTION	NAILS INCL.	LENGTH	QTY	WEIGHT
402003	LVT 150 EA	NO	12'	24	32
402004	LVT 150 EN	NO	12'	24	32
402005	LVT 150 BRZ	NO	12'	24	32
402270	LVT 150 EBLK	NO	12'	24	32
510121	LVT 150 EA-FLEX	NO	12'	12	18
510122	LVT 150 EN-FLEX	NO	12'	12	18
510123	LVT 150 BRZ-FLEX	NO	12'	12	18



3MM LVT TO CARPET TILE

ITEM	ITEM DESCRIPTION	NAILS INCL.	LENGTH	QTY	WEIGHT
402101	LVT 131 EA	NO	12'	24	36
402102	LVT 131 EN	NO	12'	24	36
402103	LVT 131 BRZ	NO	12'	24	36

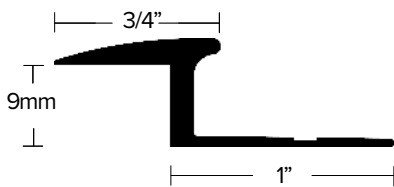

STRETCH CARPET TO 9MM

ITEM	ITEM DESCRIPTION	NAILS INCL.	LENGTH	QTY	WEIGHT
402096	LVT 190 EA	NO	12'	12	25
402097	LVT 190 EN	NO	12'	12	25
402098	LVT 190 BRZ	NO	12'	12	25

3MM LVT TO CARPET TILE

ITEM	ITEM DESCRIPTION	NAILS INCL.	LENGTH	QTY	WEIGHT
402010	LVT 350 BREA	NO	12'	40	143

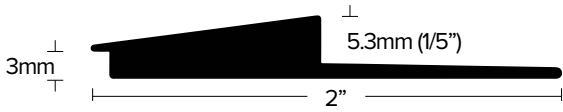

CARPET TILE REDUCERS

- Transition from carpet tile to nothing.

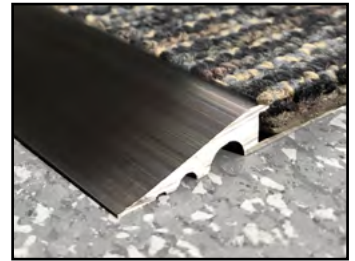

CARPET TILE TO LVT/NOTHING

ITEM	ITEM DESCRIPTION	NAILS INCL.	LENGTH	QTY	WEIGHT
402006	LVT 160 EA	NO	12'	24	34
402007	LVT 160 EN	NO	12'	24	34
402008	LVT 160 BRZ	NO	12'	24	34
402271	LVT 160 EBLK	NO	12'	24	34
510124	LVT 160 EA-FLEX	NO	12'	12	19
510125	LVT 160 EN-FLEX	NO	12'	12	19
510126	LVT 160 BRZ-FLEX	NO	12'	12	19

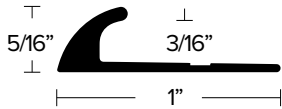

13/64" (5MM) CARPET TILE REDUCER

ITEM	ITEM DESCRIPTION	NAILS INCL.	LENGTH	QTY	WEIGHT
402065	LVT 115 EA	NO	12'	24	67
402066	LVT 115 EN	NO	12'	24	67
402067	LVT 115 BRZ	NO	12'	24	67

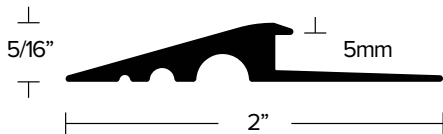

SAFETY STAIR NOSING FEATURING TREDSAFE® INSERTS



THE EDGE
ON SAFETY

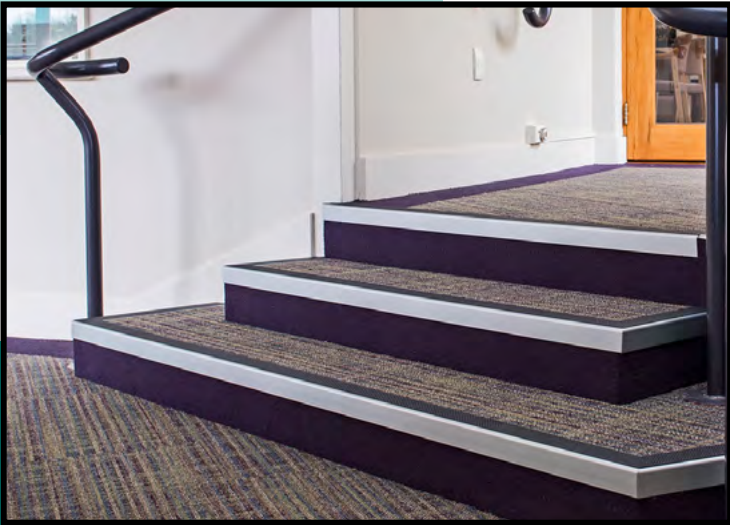

STAIR NOSING FOR CARPET

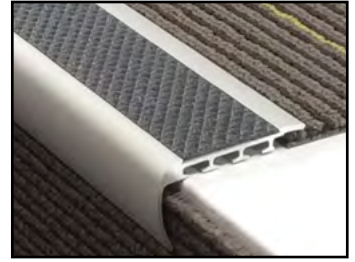

- Safety stair nosing for use with carpeted stairs.
- Tredsafe® anti-slip inserts.
- Anodized finish for durability.
- Pre-drilled and counter-sunk holes for #4 screw 82°

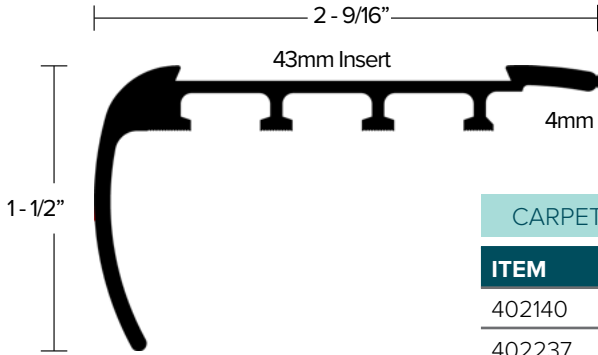

CARPET SAFETY STAIR NOSING					
ITEM	ITEM DESCRIPTION	SCREWS INCL.	LENGTH	QTY	WEIGHT
402140	AA121 EA	NO	12'	6	39
402237	AA121 EN	NO	12'	6	39
402238	AA121 BRZ	NO	12'	6	39

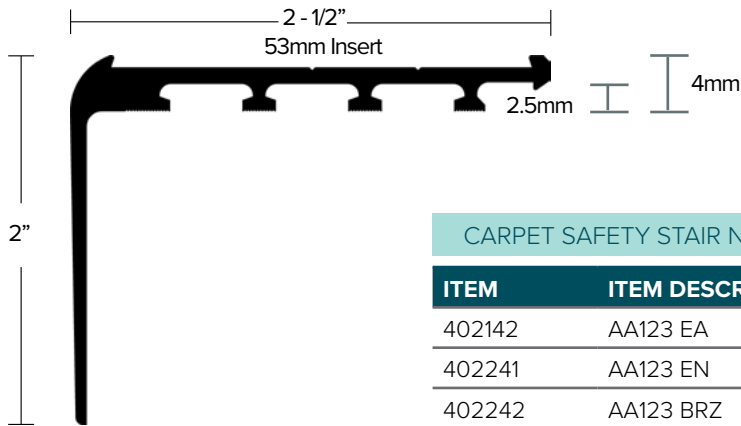

CARPET SAFETY STAIR NOSING					
ITEM	ITEM DESCRIPTION	SCREWS INCL.	LENGTH	QTY	WEIGHT
402142	AA123 EA	NO	12'	6	39
402241	AA123 EN	NO	12'	6	39
402242	AA123 BRZ	NO	12'	6	39

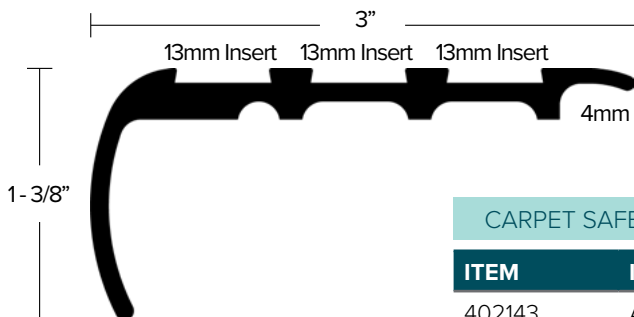

CARPET SAFETY STAIR NOSING					
ITEM	ITEM DESCRIPTION	SCREWS INCL.	LENGTH	QTY	WEIGHT
402143	AA345 EA	NO	12'	6	53
402244	AA345 EN	NO	12'	6	53
402243	AA345 BRZ	NO	12'	6	53

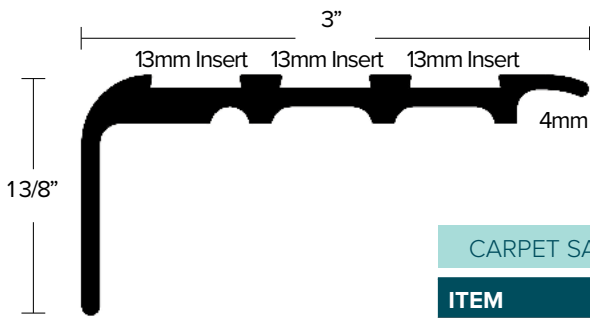

CARPET SAFETY STAIR NOSING

ITEM	ITEM DESCRIPTION	SCREWS INCL.	LENGTH	QTY	WEIGHT
402128	AA346 EA	NO	12'	6	52
402245	AA346 EN	NO	12'	6	52
402246	AA356 BRZ	NO	12'	6	52

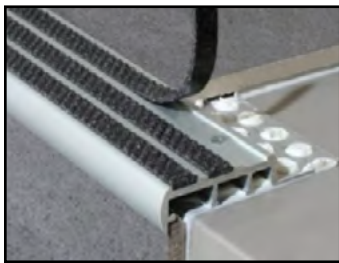

STAIR NOSING FOR CERAMIC

- Safety stair nosing for use with ceramic floor.
- Tredsafe® anti-slip inserts.
- Anodized finish for durability.
- Pre-drilled and counter-sunk holes for #4 screw 82°

SAFETY STAIR NOSING FOR CERAMIC

ITEM	ITEM DESCRIPTION	SCREWS INCL.	LENGTH	QTY	WEIGHT
402147	AA351 EA	NO	12'	6	56
402248	AA351 EN	NO	12'	6	56
402247	AA351 BRZ	NO	12'	6	56

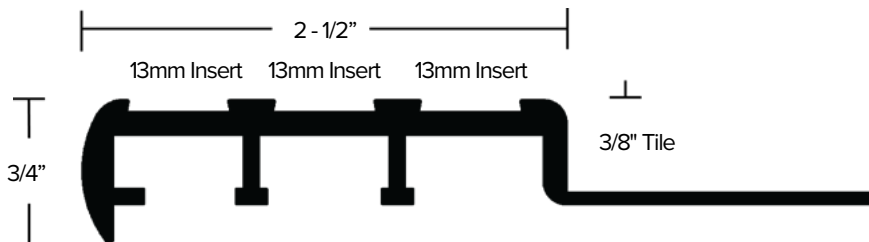

STAIR NOSING FOR BARE FLOOR

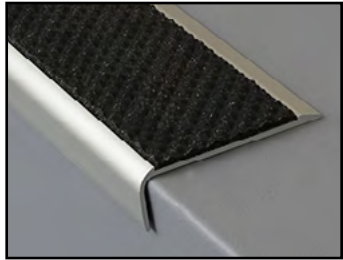

- Safety stair nosing for use with bare floor.
- Tredsafe® anti-slip inserts.
- Anodized finish for durability.
- Pre-drilled and counter-sunk holes for #4 screw 82°

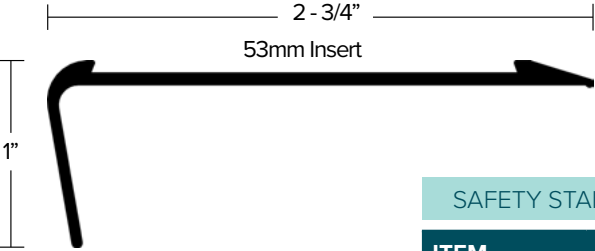

SAFETY STAIR NOSING FOR BARE FLOOR					
ITEM	ITEM DESCRIPTION	SCREWS INCL.	LENGTH	QTY	WEIGHT
402141	AA125 EA	NO	12'	6	22
402240	AA125 EN	NO	12'	6	22
402239	AA125 BRZ	NO	12'	6	22

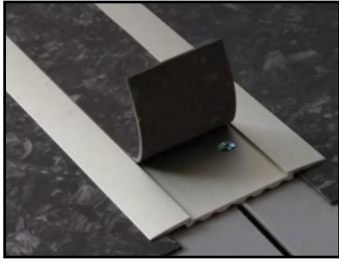

SAFETY JOINER FOR VINYL

- Safety jointer for use with 2mm sheet vinyl.
- Can be used with Tredsafe® 53mm anti-slip inserts.
- Joiner insert area can also be filled with 53mm length of 2mm vinyl for a continuous look.
- Anodized finish for durability.
- Pre-drilled and counter-sunk holes for #4 screw 82°

SAFETY JOINER

ITEM	ITEM DESCRIPTION	SCREWS INCL.	LENGTH	QTY	WEIGHT
402250	DT025 EA	NO	12'	12	58
402251	DT025 EN	NO	12'	12	58
402252	DT025 BRZ	NO	12'	12	58

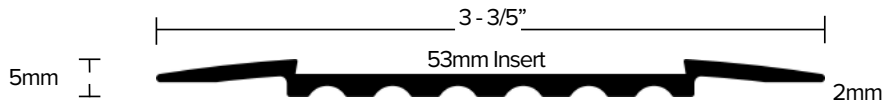

SAFETY JOINER FOR CARPET

- Safety jointer for use with carpet tile.
- Joiner insert area can be filled with 50mm length of carpet tile for a continuous look.
- Anodized finish for durability.
- Pre-drilled and counter-sunk holes for #4 screw 82°

SAFETY JOINER

ITEM	ITEM DESCRIPTION	SCREWS INCL.	LENGTH	QTY	WEIGHT
402283	DT026 EA	NO	12'	12	87
402284	DT026 EN	NO	12'	12	87
402285	DT026 BRZ	NO	12'	12	87
402286	DT026 EBLK	NO	12'	12	87

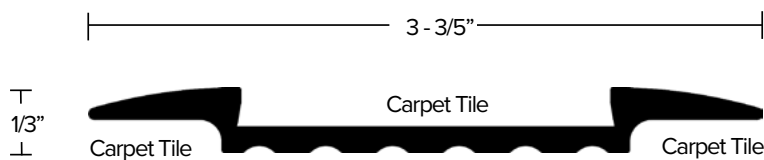

SAFETY TRANSITION FOR CARPET

- Transitions from carpet tile to various sizes of LVT and sheet vinyl
- For use with Tredsafe® 13mm anti-slip inserts.
- Anodized finish for durability.
- Pre-drilled and counter-sunk holes for #4 screw 82°

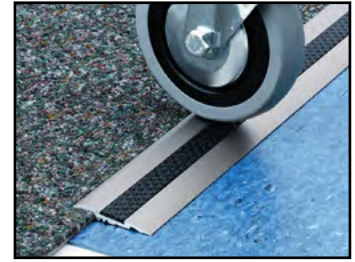

SAFETY TRANSITION 2MM SHEET VINYL OR LVT TO CARPET TILE

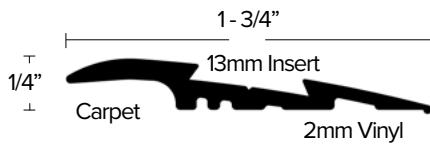

ITEM	ITEM DESCRIPTION	SCREWS INCL.	LENGTH	QTY	WEIGHT
402279	DT024 EA	NO	12'	12	31
402280	DT024 EN	NO	12'	12	31
402281	DT024 BRZ	NO	12'	12	31
402282	DT024 EBLK	NO	12'	12	31

SAFETY TRANSITION 3MM LVT TO CARPET TILE

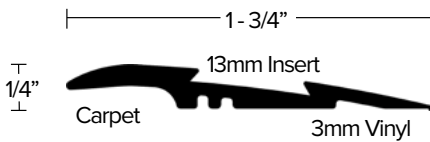

ITEM	ITEM DESCRIPTION	SCREWS INCL.	LENGTH	QTY	WEIGHT
402287	DT027 EA	NO	12'	12	31
402288	DT027 EN	NO	12'	12	31
402289	DT027 BRZ	NO	12'	12	31
402290	DT027 EBLK	NO	12'	12	31

SAFETY TRANSITION BARE FLOOR TO CARPET TILE

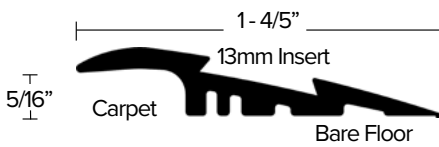

ITEM	ITEM DESCRIPTION	SCREWS INCL.	LENGTH	QTY	WEIGHT
402291	DT028 EA	NO	12'	12	37
402292	DT028 EN	NO	12'	12	37
402293	DT028 BRZ	NO	12'	12	37
402294	DT028 EBLK	NO	12'	12	37

SAFETY TRANSITION 5MM LVT TO CARPET TILE

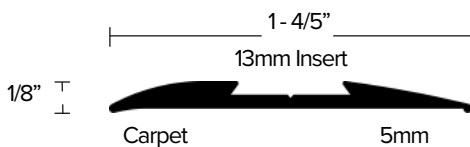

ITEM	ITEM DESCRIPTION	SCREWS INCL.	LENGTH	QTY	WEIGHT
402295	DT029 EA	NO	12'	12	28
402296	DT029 EN	NO	12'	12	28
402297	DT029 BRZ	NO	12'	12	28
402298	DT029 EBLK	NO	12'	12	28

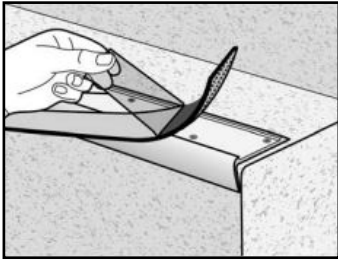

TREDSAFE® INSERTS

Tredsafe insert is manufactured from a special blend of PVC, silica quartz and polymeric plasticiser giving an homogeneous hard wearing anti-slip flooring for wet and dry conditions. Tredsafe insert is resistant to attack from ultraviolet light, oil, grease, gasoline, salt, dilute acids and alkalies, common household chemicals and detergents. Organic solvents will soften Tredsafe insert. Suitable for interior or exterior use.

TREDSAFE INSERTS

ITEM	ITEM DESCRIPTION	WIDTH	LENGTH	QTY
402164	NEUTRAL BLACK	13MM	36	6
402165	NEUTRAL BLACK	43MM	12	6
402167	NEUTRAL BLACK	53MM	12	6
402168	SAFETY ORANGE	13MM	12	6
402169	SAFETY ORANGE	43MM	12	6
402170	SAFETY ORANGE	53MM	12	6
402171	SIGNAL YELLOW	13MM	12	6
402172	SIGNAL YELLOW	43MM	12	6
402173	SIGNAL YELLOW	53MM	12	6
402192	MID GREY	13MM	12	6
402193	MID GREY	43MM	12	6
402194	MID GREY	53MM	12	6
402201	RICH BROWN	13MM	12	6
402202	RICH BROWN	43MM	12	6
402203	RICH BROWN	53MM	12	6
402186	CHARCOAL	13MM	12	6
402187	CHARCOAL	43MM	12	6
402188	CHARCOAL	53MM	12	6

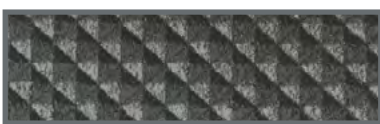
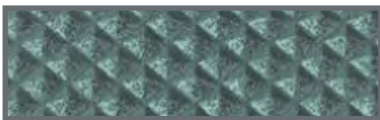

SPECIAL ORDER TREDSAFE® INSERTS

For more color options see the complete line of Tredsafe insert colors below including luminescent "glow-in-the-dark" inserts. For larger projects, custom colors can easily be created.

Please note that special order Tredsafe inserts have longer lead times.

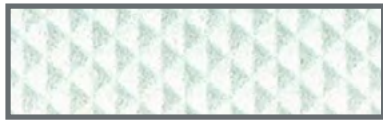

SPECIAL ORDER TREDSAFE INSERTS				
ITEM	ITEM DESCRIPTION	WIDTH	LENGTH	QTY
402174	SAFETY WHITE	13MM	12	6
402175	SAFETY WHITE	43MM	12	6
402176	SAFETY WHITE	53MM	12	6
402177	SAFETY BLUE	13MM	12	6
402178	SAFETY BLUE	43MM	12	6
402179	SAFETY BLUE	53MM	12	6
402180	SAFETY GREEN	13MM	12	6
402181	SAFETY GREEN	43MM	12	6
402182	SAFETY GREEN	53MM	12	6
402183	SAFETY RED	13MM	12	6
402184	SAFETY RED	43MM	12	6
402185	SAFETY RED	53MM	12	6
402189	LIGHT GREY	13MM	12	6
402190	LIGHT GREY	43MM	12	6
402191	LIGHT GREY	53MM	12	6
402216	LUMITRED	13MM	12	6
402217	LUMITRED	43MM	12	6
402218	LUMITRED	53MM	12	6



INSTALLATION OF TREDSAFE® INSERTS

Step 1

Ensure the aluminum channel is clean from dust, residues and debris. Wipe down with a cleaning solvent (Isopropyl Alcohol or similar).

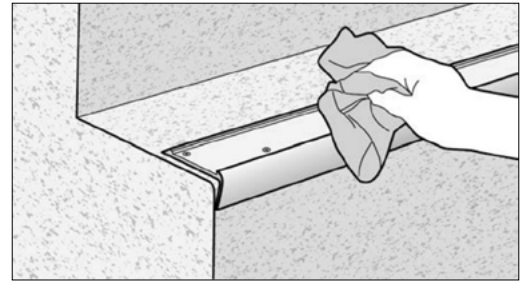

Step 2

Precut the Insert to your required length.

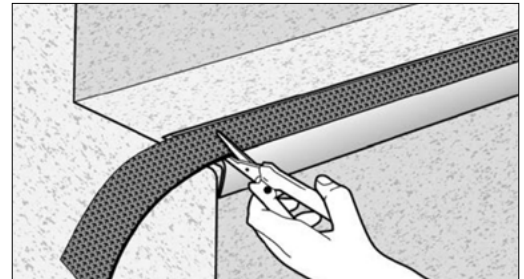

Step 3

Remove the adhesive backing liner from the Tredsafe® Insert.

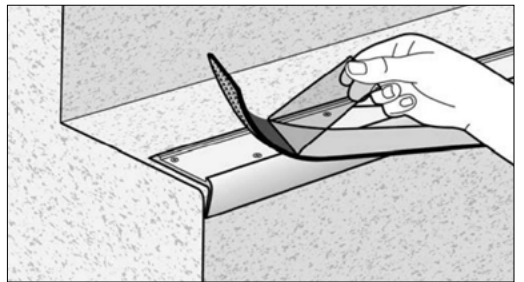

Step 4

Install by placing the Insert into the nosing and pressing into place without undue stretching.

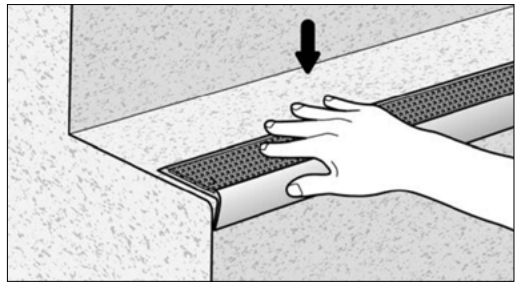

Step 5

Once in place, roll over the Insert to ensure consistent adhesion and a secure bond. Please take care not to stretch the Insert when rolling. Installation is now complete.

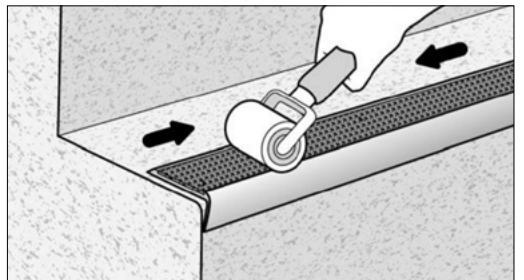

LVT TRIMS & TRANSITIONS

 Designer trims made to protect and enhance your flooring investment. Introducing our latest line of commercial and residential trims and transitions made specifically for the expanding LVT/Resilient market.



NO-LIP RAMPS & JOINERS

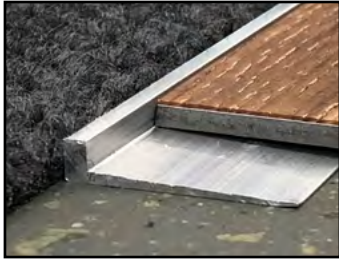

- Transition from LVT to carpet tile.
- Transition from LVT to nothing.
- Transition from LVT or other resilient of different size.
- Joiner from LVT or other resilient of same size.

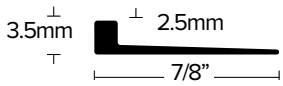

2.5MM to 3.5MM LVT NO-LIP RAMP

ITEM	ITEM DESCRIPTION	NAILS INCL.	LENGTH	QTY	WEIGHT
402079	LVT 123 MF	NO	12'	24	25

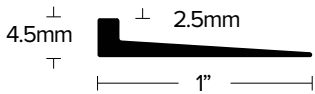

2.5MM to 4.5MM LVT NO-LIP RAMP

ITEM	ITEM DESCRIPTION	NAILS INCL.	LENGTH	QTY	WEIGHT
402052	LVT 124 MF	NO	12'	24	25

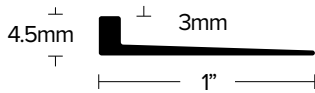

3MM to 4.5MM LVT NO-LIP RAMP

ITEM	ITEM DESCRIPTION	NAILS INCL.	LENGTH	QTY	WEIGHT
402021	LVT 125 MF	NO	12'	24	25
402088	LVT 125 EN	NO	12'	24	25
402089	LVT 125 BRZ	NO	12'	24	25
510127	LVT 125 MF-FLEX	NO	12'	24	25

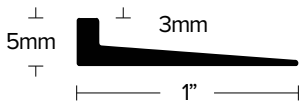

3MM to 5MM LVT NO-LIP RAMP

ITEM	ITEM DESCRIPTION	NAILS INCL.	LENGTH	QTY	WEIGHT
402051	LVT 127 MF	NO	12'	24	26

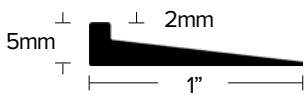

2MM to 5MM LVT NO-LIP RAMP

ITEM	ITEM DESCRIPTION	NAILS INCL.	LENGTH	QTY	WEIGHT
402272	LVT 118 MF	NO	12'	24	31

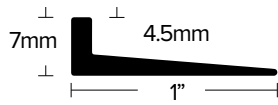

4.5MM to 7MM LVT RAMP

ITEM	ITEM DESCRIPTION	NAILS INCL.	LENGTH	QTY	WEIGHT
402081	LVT 121 MF	NO	12'	24	33

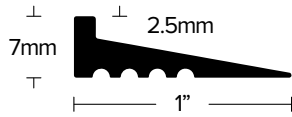

2.5MM to 7MM LVT RAMP

ITEM	ITEM DESCRIPTION	NAILS INCL.	LENGTH	QTY	WEIGHT
402078	LVT 129 MF	NO	12'	24	38

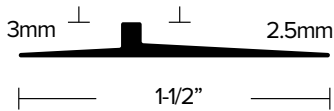

2.5MM to 3MM LVT NO-LIP JOINER

ITEM	ITEM DESCRIPTION	NAILS INCL.	LENGTH	QTY	WEIGHT
402077	LVT 128 MF	NO	12'	24	28

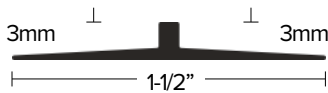

3MM to 3MM LVT NO-LIP JOINER

ITEM	ITEM DESCRIPTION	NAILS INCL.	LENGTH	QTY	WEIGHT
402093	LVT 133 MF	NO	12'	24	28



5MM to 5MM LVT NO-LIP JOINER

ITEM	ITEM DESCRIPTION	NAILS INCL.	LENGTH	QTY	WEIGHT
402094	LVT 155 MF	NO	12'	24	30
402256	LVT 155 EN	NO	12'	24	30
402255	LVT 155 BRZ	NO	12'	24	30

14MM to 6MM LVT RAMP

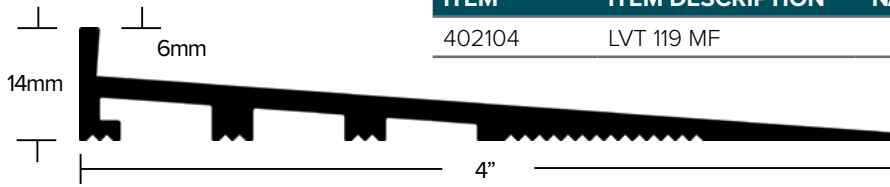

ITEM	ITEM DESCRIPTION	NAILS INCL.	LENGTH	QTY	WEIGHT
402104	LVT 119 MF	NO	12'	6	47

15MM to 4.5MM LVT RAMP

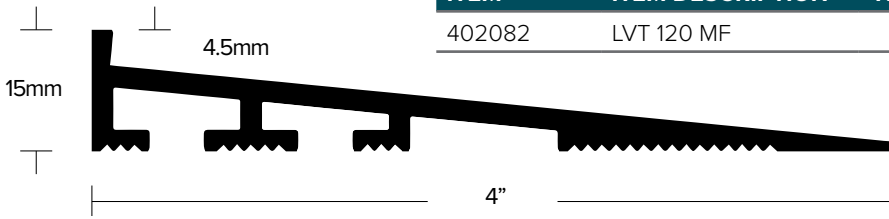

ITEM	ITEM DESCRIPTION	NAILS INCL.	LENGTH	QTY	WEIGHT
402082	LVT 120 MF	NO	12'	6	51

15MM to 7MM LVT RAMP

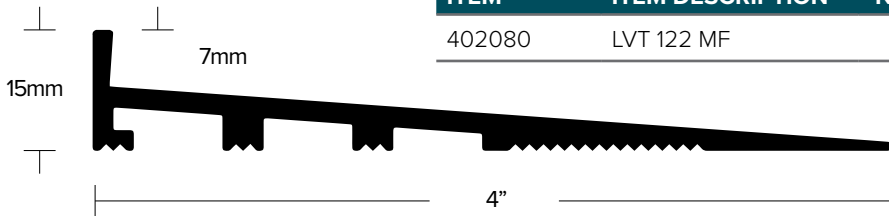

ITEM	ITEM DESCRIPTION	NAILS INCL.	LENGTH	QTY	WEIGHT
402080	LVT 122 MF	NO	12'	6	47

15MM to 3MM LVT RAMP

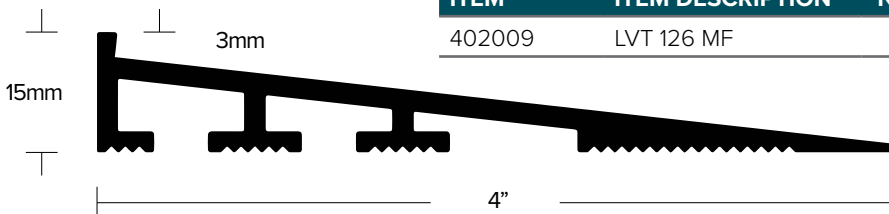

ITEM	ITEM DESCRIPTION	NAILS INCL.	LENGTH	QTY	WEIGHT
402009	LVT 126 MF	NO	12'	6	57



CARPET TILE TO LVT

- Transitions from carpet tile to LVT of 3 or 5 mm height.

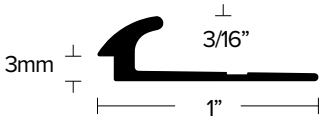

3MM LVT TO CARPET TILE					
ITEM	ITEM DESCRIPTION	NAILS INCL.	LENGTH	QTY	WEIGHT
402000	LVT 130 EA	NO	12'	24	31
402001	LVT 130 EN	NO	12'	24	31
402002	LVT 130 BRZ	NO	12'	24	31
402269	LVT 130 EBLK	NO	12'	24	31
510118	LVT 130 EA-FLEX	NO	12'	24	31
510119	LVT 130 EN-FLEX	NO	12'	24	31
510120	LVT 130 BRZ-FLEX	NO	12'	24	31

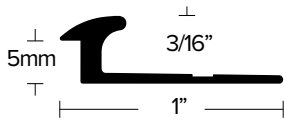

5MM LVT TO CARPET TILE					
ITEM	ITEM DESCRIPTION	NAILS INCL.	LENGTH	QTY	WEIGHT
402003	LVT 150 EA	NO	12'	24	32
402004	LVT 150 EN	NO	12'	24	32
402005	LVT 150 BRZ	NO	12'	24	32
402270	LVT 150 EBLK	NO	12'	24	32
510121	LVT 150 EA-FLEX	NO	12'	24	32
510122	LVT 150 EN-FLEX	NO	12'	24	32
510123	LVT 150 BRZ-FLEX	NO	12'	24	32



3MM LVT TO CARPET TILE (EXTENDED LIP)					
ITEM	ITEM DESCRIPTION	NAILS INCL.	LENGTH	QTY	WEIGHT
402101	LVT 131 EA	NO	12'	24	36
402102	LVT 131 EN	NO	12'	24	36
402103	LVT 131 BRZ	NO	12'	24	36

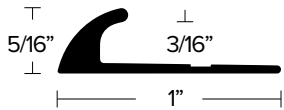

CARPET TILE TO LVT/NOTHING

ITEM	ITEM DESCRIPTION	NAILS INCL.	LENGTH	QTY	WEIGHT
402006	LVT 160 EA	NO	12'	24	34
402007	LVT 160 EN	NO	12'	24	34
402008	LVT 160 BRZ	NO	12'	24	34
402271	LVT 160 EBLK	NO	12'	24	34
510124	LVT 160 EA-FLEX	NO	12'	24	34
510125	LVT 160 EN-FLEX	NO	12'	24	34
510126	LVT 160 BRZ-FLEX	NO	12'	24	34

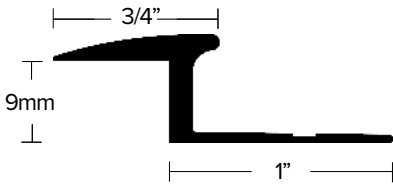

CARPET TO 9MM

ITEM	ITEM DESCRIPTION	NAILS INCL.	LENGTH	QTY	WEIGHT
402096	LVT 190 EA	NO	12'	12	25
402097	LVT 190 EN	NO	12'	12	25
402098	LVT 190 BRZ	NO	12'	12	25

3MM LVT TO CARPET TILE

ITEM	ITEM DESCRIPTION	NAILS INCL.	LENGTH	QTY	WEIGHT
402010	LVT 350 BREA	NO	12'	40	143



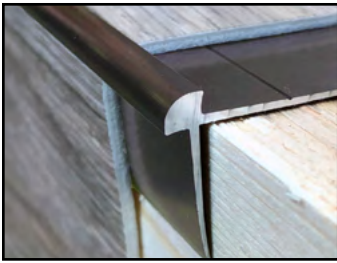

NO-LIP STAIR NOSING

- LVT transitions for both the inside and outside corners of stairs.
- LVT transitions for both inside and outside corners of wall applications.

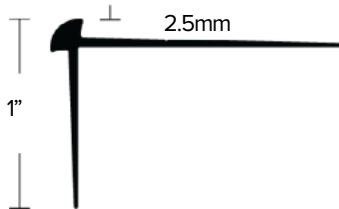

2.5MM NO-LIP STAIR NOSING					
ITEM	ITEM DESCRIPTION	NAILS INCL.	LENGTH	QTY	WEIGHT
402134	LVT 325 EA	NO	12'	12	24
402139	LVT 325 EN	NO	12'	12	24
402144	LVT 325 BRZ	NO	12'	12	24

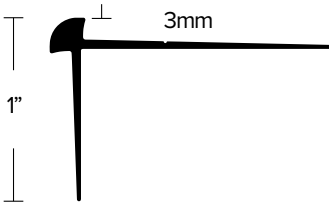

3MM NO-LIP STAIR NOSING					
ITEM	ITEM DESCRIPTION	NAILS INCL.	LENGTH	QTY	WEIGHT
402018	LVT 340 EA	NO	12'	12	24
402019	LVT 340 EN	NO	12'	12	24
402020	LVT 340 BRZ	NO	12'	12	24

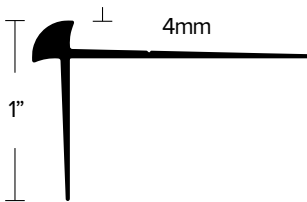

4MM NO-LIP STAIR NOSING					
ITEM	ITEM DESCRIPTION	NAILS INCL.	LENGTH	QTY	WEIGHT
402083	LVT 343 EA	NO	12'	12	26
402084	LVT 343 EN	NO	12'	12	26
402085	LVT 343 BRZ	NO	12'	12	26

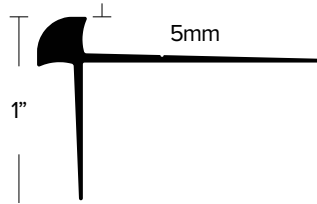

5MM NO-LIP STAIR NOSING

ITEM	ITEM DESCRIPTION	NAILS INCL.	LENGTH	QTY	WEIGHT
402046	LVT 341 EA	NO	12'	12	28
402047	LVT 341 EN	NO	12'	12	28
402048	LVT 341 BRZ	NO	12'	12	28

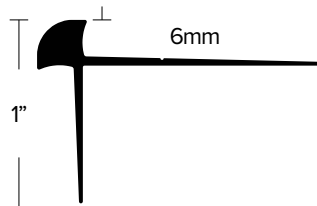

6MM NO-LIP STAIR NOSING

ITEM	ITEM DESCRIPTION	NAILS INCL.	LENGTH	QTY	WEIGHT
402226	LVT 346 EA	NO	12'	12	28
402227	LVT 346 EN	NO	12'	12	28
402228	LVT 346 BRZ	NO	12'	12	28

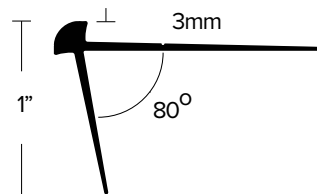

3MM NO-LIP STAIR NOSING 80° ANGLE

ITEM	ITEM DESCRIPTION	NAILS INCL.	LENGTH	QTY	WEIGHT
402011	LVT 342 EA	NO	12'	12	24
402012	LVT 342 EN	NO	12'	12	24
402013	LVT 342 BRZ	NO	12'	12	24

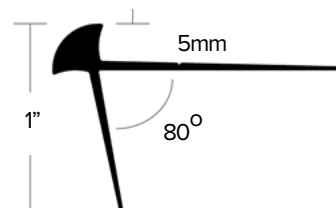

5MM NO-LIP STAIR NOSING 80° ANGLE

ITEM	ITEM DESCRIPTION	NAILS INCL.	LENGTH	QTY	WEIGHT
402220	LVT 347 EA	NO	12'	12	24
402221	LVT 347 EN	NO	12'	12	24
402222	LVT 347 BRZ	NO	12'	12	24

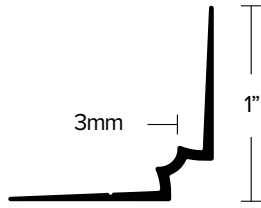

3MM NO-LIP STAIR RISER					
ITEM	ITEM DESCRIPTION	NAILS INCL.	LENGTH	QTY	WEIGHT
402015	LVT 330 EA	NO	12'	12	18
402016	LVT 330 EN	NO	12'	12	18
402017	LVT 330 BRZ	NO	12'	12	18

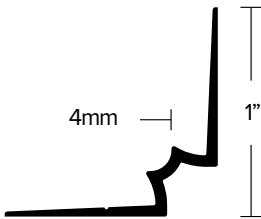

4MM NO-LIP STAIR RISER					
ITEM	ITEM DESCRIPTION	NAILS INCL.	LENGTH	QTY	WEIGHT
508735	LVT 333 EA	NO	12'	12	19
508736	LVT 333 EN	NO	12'	12	19
508737	LVT 333 BRZ	NO	12'	12	19

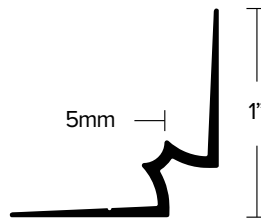

5MM NO-LIP STAIR RISER					
ITEM	ITEM DESCRIPTION	NAILS INCL.	LENGTH	QTY	WEIGHT
402014	LVT 331 EA	NO	12'	12	19
402049	LVT 331 EN	NO	12'	12	19
402050	LVT 331 BRZ	NO	12'	12	19

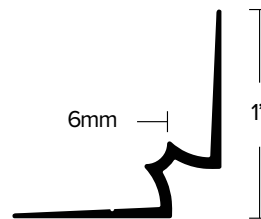

6MM NO-LIP STAIR RISER					
ITEM	ITEM DESCRIPTION	NAILS INCL.	LENGTH	QTY	WEIGHT
402231	LVT 336 EA	NO	12'	12	19
402230	LVT 336 EN	NO	12'	12	19
402229	LVT 336 BRZ	NO	12'	12	19

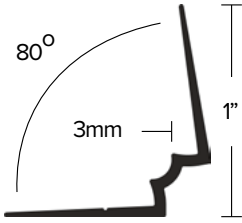

3MM NO-LIP STAIR RISER 80° ANGLE

ITEM	ITEM DESCRIPTION	NAILS INCL.	LENGTH	QTY	WEIGHT
402095	LVT 332 EA	NO	12'	12	19
402099	LVT 332 EN	NO	12'	12	19
402100	LVT 332 BRZ	NO	12'	12	19

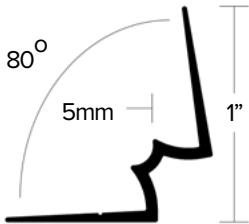

5MM NO-LIP STAIR RISER 80° ANGLE

ITEM	ITEM DESCRIPTION	NAILS INCL.	LENGTH	QTY	WEIGHT
402225	LVT 337 EA	NO	12'	12	19
402224	LVT 337 EN	NO	12'	12	19
402223	LVT 337 BRZ	NO	12'	12	19



STAIR NOSING

- Two different drops, 1-5/8" and 2"
- Available in various sizes

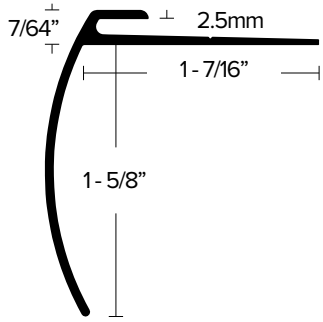

2.5MM LVT STAIR NOSING

ITEM	ITEM DESCRIPTION	NAILS INCL.	LENGTH	QTY	WEIGHT
402037	LVT 625 EA	NO	12'	12	36
402038	LVT 625 EN	NO	12'	12	36
402039	LVT 625 BRZ	NO	12'	12	36
402268	LVT 625 EBLK	NO	12'	12	36

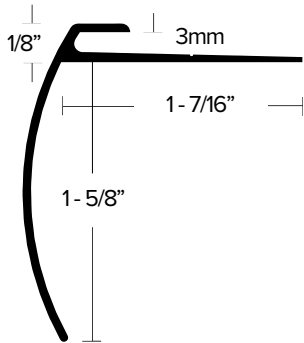

3MM LVT STAIR NOSING

ITEM	ITEM DESCRIPTION	NAILS INCL.	LENGTH	QTY	WEIGHT
402040	LVT 630 EA	NO	12'	12	37
402041	LVT 630 EN	NO	12'	12	37
402042	LVT 630 BRZ	NO	12'	12	37

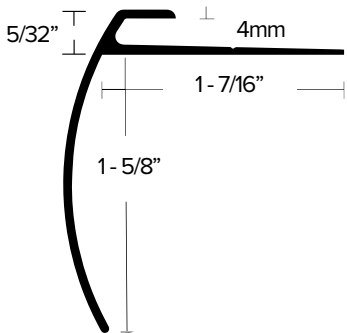

4MM LVT STAIR NOSING

ITEM	ITEM DESCRIPTION	NAILS INCL.	LENGTH	QTY	WEIGHT
401176	LVT 606 EA	NO	12'	12	37
401177	LVT 606 EN	NO	12'	12	37
401175	LVT 606 BRZ	NO	12'	12	37

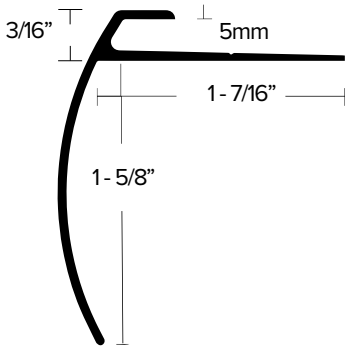

5MM LVT STAIR NOSING					
ITEM	ITEM DESCRIPTION	NAILS INCL.	LENGTH	QTY	WEIGHT
389141	LVT 608 EA	NO	12'	12	37
389143	LVT 608 EN	NO	12'	12	37
390168	LVT 608 BRZ	NO	12'	12	37
389142	LVT 608 EB	NO	12'	12	37
402273	LVT 608 EBLK	NO	12'	12	37

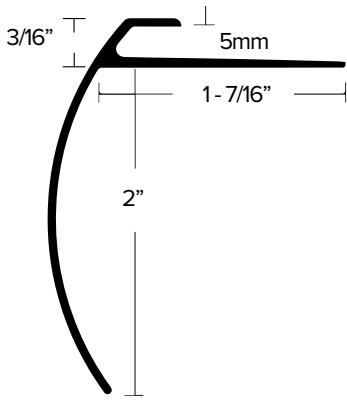

5MM LVT STAIR NOSING LONG					
ITEM	ITEM DESCRIPTION	NAILS INCL.	LENGTH	QTY	WEIGHT
401178	LVT 610 EA	NO	12'	12	41
401179	LVT 610 EN	NO	12'	12	41
401180	LVT 610 BRZ	NO	12'	12	41

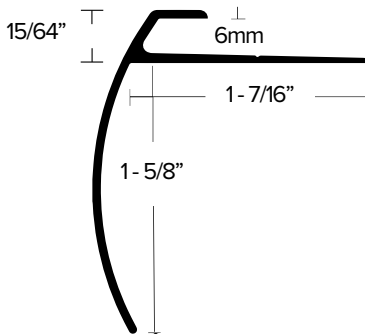

6MM LVT STAIR NOSING					
ITEM	ITEM DESCRIPTION	NAILS INCL.	LENGTH	QTY	WEIGHT
401197	LVT 604 EA	NO	12'	12	37
401198	LVT 604 EN	NO	12'	12	37
401196	LVT 604 BRZ	NO	12'	12	37

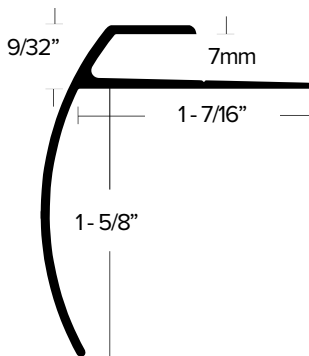

7MM LVT STAIR NOSING WITH EXTENDED LIP					
ITEM	ITEM DESCRIPTION	NAILS INCL.	LENGTH	QTY	WEIGHT
402043	LVT 612 EA	NO	12'	12	40
402044	LVT 612 EN	NO	12'	12	40
402045	LVT 612 BRZ	NO	12'	12	40

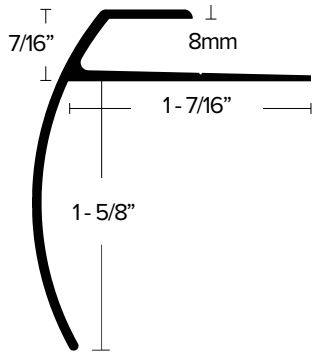

8MM LVT STAIR NOSING WITH EXTENDED LIP

ITEM	ITEM DESCRIPTION	NAILS INCL.	LENGTH	QTY	WEIGHT
402059	LVT 618 EA	NO	12'	12	40
402060	LVT 618 EN	NO	12'	12	40
402061	LVT 618 BRZ	NO	12'	12	40

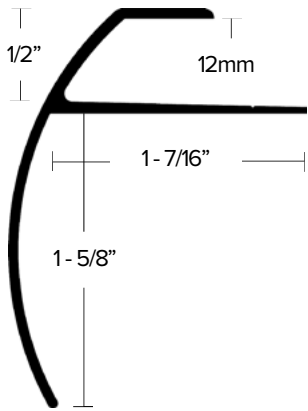

12MM LVT STAIR NOSING WITH EXTENDED LIP

ITEM	ITEM DESCRIPTION	NAILS INCL.	LENGTH	QTY	WEIGHT
402278	LVT 622 EA	NO	12'	12	41
402299	LVT 622 EN	NO	12'	12	41
402300	LVT 622 BRZ	NO	12'	12	41
402301	LVT 622 EBLK	NO	12'	12	41



BEVEL CAPS

- Can be used as end cap in wall application.

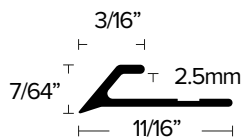

2.5MM BEVEL CAP

ITEM	ITEM DESCRIPTION	NAILS INCL.	LENGTH	QTY	WEIGHT
402022	LVT 425 EA	NO	12'	24	18
402023	LVT 425 EN	NO	12'	24	18
402024	LVT 425 BRZ	NO	12'	24	18

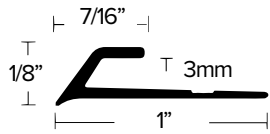

3MM BEVEL CAP

ITEM	ITEM DESCRIPTION	NAILS INCL.	LENGTH	QTY	WEIGHT
390156	LVT 406 EA	NO	12'	24	26
390157	LVT 406 EN	NO	12'	24	26
390158	LVT 406 BRZ	NO	12'	24	26

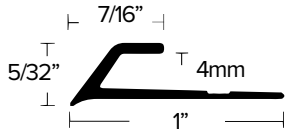

4MM BEVEL CAP

ITEM	ITEM DESCRIPTION	NAILS INCL.	LENGTH	QTY	WEIGHT
390153	LVT 404 EA	NO	12'	24	27
390154	LVT 404 EN	NO	12'	24	27
390155	LVT 404 BRZ	NO	12'	24	27

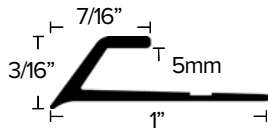

5MM BEVEL CAP

ITEM	ITEM DESCRIPTION	NAILS INCL.	LENGTH	QTY	WEIGHT
390159	LVT 405 EA	NO	12'	24	28
390160	LVT 405 EN	NO	12'	24	28
390161	LVT 405 BRZ	NO	12'	24	28

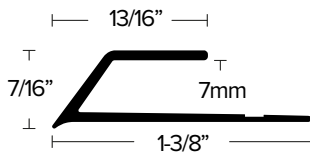

7MM BEVEL CAP EXTENDED LIP

ITEM	ITEM DESCRIPTION	NAILS INCL.	LENGTH	QTY	WEIGHT
402025	LVT 407 EA	NO	12'	24	41
402026	LVT 407 EN	NO	12'	24	41
402027	LVT 407 BRZ	NO	12'	24	41

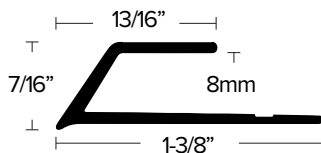

8MM BEVEL CAP EXTENDED LIP

ITEM	ITEM DESCRIPTION	NAILS INCL.	LENGTH	QTY	WEIGHT
402071	LVT 408 EA	NO	12'	24	41
402072	LVT 408 EN	NO	12'	24	41
402073	LVT 408 BRZ	NO	12'	24	41



SQUARE CAPS

- Transitions from LVT to ceramic tile, wood or other surfaces of equal height.
- Can be used as end cap in wall application or LVT to fixture such as bathtub or vanity

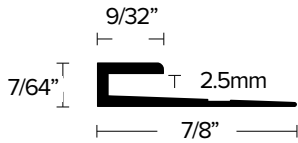

2.5MM SQUARE CAP

ITEM	ITEM DESCRIPTION	NAILS INCL.	LENGTH	QTY	WEIGHT
402028	LVT 925 EA	NO	12'	24	23
402029	LVT 925 EN	NO	12'	24	23
402030	LVT 925 BRZ	NO	12'	24	23

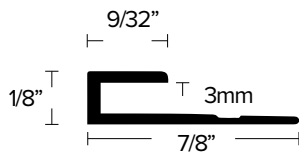

3MM SQUARE CAP

ITEM	ITEM DESCRIPTION	NAILS INCL.	LENGTH	QTY	WEIGHT
402031	LVT 906 EA	NO	12'	24	23
402032	LVT 906 EN	NO	12'	24	23
402033	LVT 906 BRZ	NO	12'	24	23

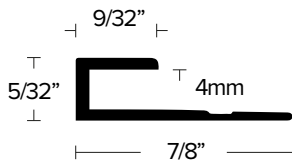

4MM SQUARE CAP

ITEM	ITEM DESCRIPTION	NAILS INCL.	LENGTH	QTY	WEIGHT
403263	LVT 904 EA	NO	12'	24	22
403264	LVT 904 EN	NO	12'	24	22
403265	LVT 904 BRZ	NO	12'	24	22

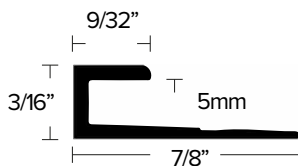

5MM SQUARE CAP

ITEM	ITEM DESCRIPTION	NAILS INCL.	LENGTH	QTY	WEIGHT
403262	LVT 905 EA	NO	12'	24	22
403261	LVT 905 EN	NO	12'	24	22
403260	LVT 905 BRZ	NO	12'	24	22
402267	LVT 905 EBLK	NO	12'	24	22

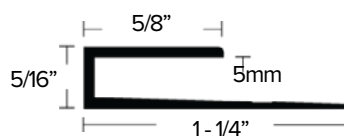

5MM SQUARE CAP EXTENDED LIP

ITEM	ITEM DESCRIPTION	NAILS INCL.	LENGTH	QTY	WEIGHT
402157	LVT 915 EA	NO	12'	24	33
402156	LVT 915 EN	NO	12'	24	33
402155	LVT 915 BRZ	NO	12'	24	33

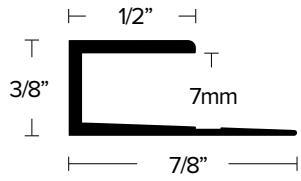

7MM SQUARE CAP EXTENDED LIP

ITEM	ITEM DESCRIPTION	NAILS INCL.	LENGTH	QTY	WEIGHT
402034	LVT 907 EA	NO	12'	24	29
402035	LVT 907 EN	NO	12'	24	29
402036	LVT 907 BRZ	NO	12'	24	29

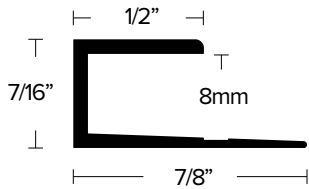

8MM SQUARE CAP EXTENDED LIP

ITEM	ITEM DESCRIPTION	NAILS INCL.	LENGTH	QTY	WEIGHT
402062	LVT 908 EA	NO	12'	24	30
402063	LVT 908 EN	NO	12'	24	30
402064	LVT 908 BRZ	NO	12'	24	30

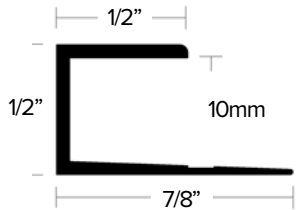

10MM SQUARE CAP

ITEM	ITEM DESCRIPTION	NAILS INCL.	LENGTH	QTY	WEIGHT
402232	LVT 910 EA	NO	12'	24	34
402233	LVT 910 EN	NO	12'	24	34
402234	LVT 910 BRZ	NO	12'	24	34

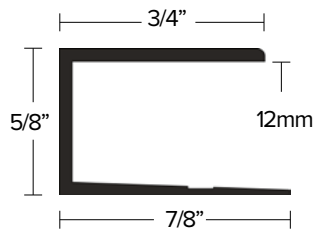

12MM SQUARE CAP EXTENDED LIP

ITEM	ITEM DESCRIPTION	NAILS INCL.	LENGTH	QTY	WEIGHT
402090	LVT 912 EA	NO	12'	24	36
402091	LVT 912 EN	NO	12'	24	36
402092	LVT 912 BRZ	NO	12'	24	36



CERAMIC TILE TO LVT

- Transition from tile to lower elevation LVT flooring that is already installed.
- Lays over an uneven end of LVT flooring, reduces rework time.

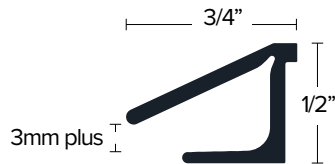

1/2" EXISTING TILE REDUCER

ITEM	ITEM DESCRIPTION	NAILS INCL.	LENGTH	QTY	WEIGHT
415501	ETR 38 EA	NO	12'	24	34
415500	ETR 38 EN	NO	12'	24	34
415502	ETR 38 BRZ	NO	12'	24	34

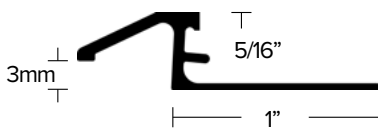

5/16" **edgetek** TILE TO 3MM LVT

ITEM	ITEM DESCRIPTION	NAILS INCL.	LENGTH	QTY	WEIGHT
415372	Edgetek TLVT 516 EA	NO	98.5"	12	15
415373	Edgetek TLVT 516 EN	NO	98.5"	12	15

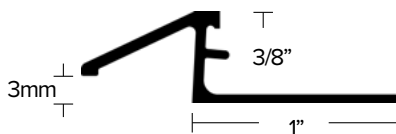

3/8" **edgetek** TILE TO 3MM LVT

ITEM	ITEM DESCRIPTION	NAILS INCL.	LENGTH	QTY	WEIGHT
415380	Edgetek TLVT 38 EA	NO	98.5"	12	15
415381	Edgetek TLVT 38 EN	NO	98.5"	12	15
415382	Edgetek TLVT 38 BRZ	NO	98.5"	12	15

LVT JOINERS

- Aluminum divider used to join LVT of same height where seam is needed.

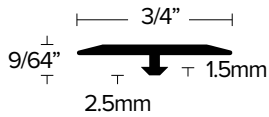
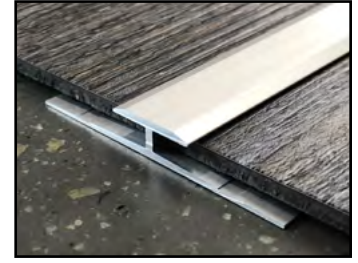

2.5MM LVT BARBED JOINER

ITEM	ITEM DESCRIPTION	NAILS INCL.	LENGTH	QTY	WEIGHT
402074	LVT 102 EA	NO	12'	24	19
402075	LVT 102 EN	NO	12'	24	19
402076	LVT 102 BRZ	NO	12'	24	19

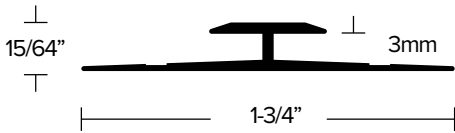

3MM LVT JOINER

ITEM	ITEM DESCRIPTION	NAILS INCL.	LENGTH	QTY	WEIGHT
402056	LVT 103 EA	NO	12'	24	36
402057	LVT 103 EN	NO	12'	24	36
402058	LVT 103 BRZ	NO	12'	24	36

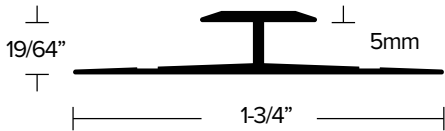

5MM LVT JOINER

ITEM	ITEM DESCRIPTION	NAILS INCL.	LENGTH	QTY	WEIGHT
402053	LVT 105 EA	NO	12'	24	38
402054	LVT 105 EN	NO	12'	24	38
402055	LVT 105 BRZ	NO	12'	24	38

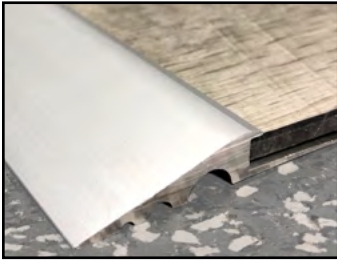

REDUCERS

- Transition from LVT to nothing.
- Transition from LVT to other resilient.

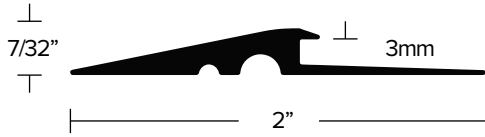

1/8" (3MM) LVT REDUCER

ITEM	ITEM DESCRIPTION	NAILS INCL.	LENGTH	QTY	WEIGHT
402068	LVT 113 EA	NO	12'	24	66
402069	LVT 113 EN	NO	12'	24	66
402070	LVT 113 BRZ	NO	12'	24	66

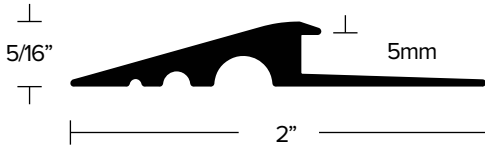

13/64" (5MM) LVT REDUCER

ITEM	ITEM DESCRIPTION	NAILS INCL.	LENGTH	QTY	WEIGHT
402065	LVT 115 EA	NO	12'	24	67
402066	LVT 115 EN	NO	12'	24	67
402067	LVT 115 BRZ	NO	12'	24	67

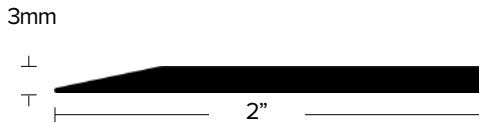

3MM LVT NO-LIP REDUCER

ITEM	ITEM DESCRIPTION	NAILS INCL.	LENGTH	QTY	WEIGHT
402264	LVT 303 EA	NO	12'	24	59
402265	LVT 303 EN	NO	12'	24	59
402274	LVT 303 BRZ	NO	12'	24	59
402266	VLT 303 BREA	NO	12'	24	59

CERAMIC FLOORING & WALL TRIMS



Trims and transitions made specifically to protect and enhance ceramic tile installations.

edgetek[™]
BY BONNELL ALUMINUM



CREATING THE PERFECT GROUT LINE

Edgetek[™] has been engineered to create a perfect grout line by extruding a feature into the product that holds the tile the perfect distance from the reveal along the length of the trim. This allows you to create a perfectly straight grout line that looks great every time. Look for the **edgetek**[™] logo to select trim featuring the Edgetek feature.

L SHAPE TRIMS

- Provides edge on tiles that eliminates chipping and cracking of tile.
- Allows for straight edge grout line each time on Edgetek trims.

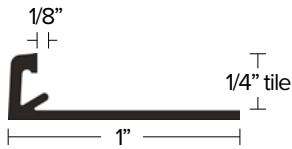

1/4" edgetek L SHAPE

ITEM	ITEM DESCRIPTION	COMPARE TO	LENGTH	QTY	WEIGHT
415400	Edgetek L 14 EA	AE 60	98.5"	12	12
415401	Edgetek L 14 EN	A 60 AT	98.5"	12	12

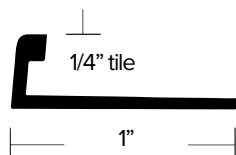

1/4" TILE TRIM

ITEM	ITEM DESCRIPTION	COMPARE TO	LENGTH	QTY	WEIGHT
415010	TT 14 EA	NA	96"	12	12
415097	TT 14 EN	NA	96"	12	12

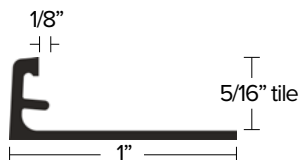

5/16" edgetek L SHAPE

ITEM	ITEM DESCRIPTION	COMPARE TO	LENGTH	QTY	WEIGHT
415402	Edgetek L 516 EA	AE 80	98.5"	12	12
415403	Edgetek L 516 EN	A 80 AT	98.5"	12	12
415404	Edgetek L 516 BRZ	NA	98.5"	12	12
415405	Edgetek L 516 EBLK	A 80 AGSG	98.5"	12	12
415379	Edgetek L 516 MF	A 80	98.5"	12	12

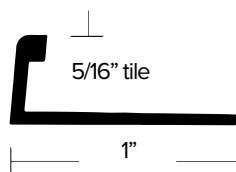

5/16" TILE TRIM

ITEM	ITEM DESCRIPTION	COMPARE TO	LENGTH	QTY	WEIGHT
415020	TT 516 EA	NA	96"	12	8
415032	TT 516 EN	NA	96"	12	8
415366	TT 516 WHITE	NA	96"	12	8
415367	TT 516 PERGAMON	NA	96"	12	8
415368	TT 516 GREY	NA	96"	12	8

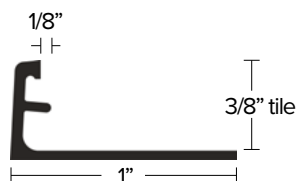

3/8" edgetek L SHAPE

ITEM	ITEM DESCRIPTION	COMPARE TO	LENGTH	QTY	WEIGHT
415406	Edgetek L 38 EA	AE 100	98.5"	12	13
415407	Edgetek L 38 EN	A 100 AT	98.5"	12	13
415408	Edgetek L 38 EB	A 100 AM	98.5"	12	13
415409	Edgetek L 38 BRZ	NA	98.5"	12	13
415410	Edgetek L 38 EBLK	A 100 AGSG	98.5"	12	13
415376	Edgetek L 38 MF	A 100	98.5"	12	13

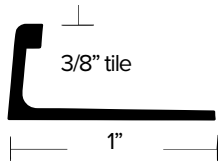

3/8" TILE TRIM

ITEM	ITEM DESCRIPTION	COMPARE TO	LENGTH	QTY	WEIGHT
415030	TT 38 EA	NA	96"	12	8
415038	TT 38 EN	NA	96"	12	8
415369	TT 38 WHITE	NA	96"	12	8
415370	TT 38 PERGAMON	NA	96"	12	8
415371	TT 38 GREY	NA	96"	12	8

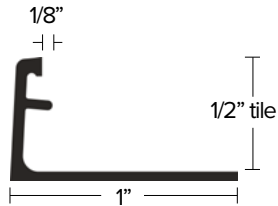

1/2" edgetek® L SHAPE

ITEM	ITEM DESCRIPTION	COMPARE TO	LENGTH	QTY	WEIGHT
415411	Edgetek L 12 EA	AE 125	98.5"	12	13
415412	Edgetek L12 EN	A 125 AT	98.5"	12	13
415413	Edgetek L 12 BRZ	NA	98.5"	12	13

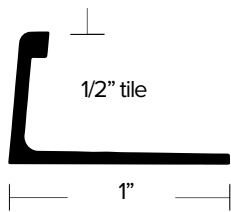

1/2" TILE TRIM

ITEM	ITEM DESCRIPTION	COMPARE TO	LENGTH	QTY	WEIGHT
415040	TT 12 EA	NA	96"	12	8
415099	TT 12 EN	NA	96"	12	8
415098	TT 12 EB	NA	96"	12	8
415045	TT 12 BDB	NA	96"	12	8
415157	TT 12 EBLK	NA	96"	12	8

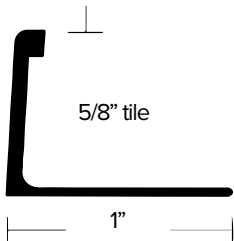

5/8" TILE TRIM

ITEM	ITEM DESCRIPTION	COMPARE TO	LENGTH	QTY	WEIGHT
415054	TT 58 EA	NA	96"	12	9
415378	TT 58 EBLK	NA	96"	12	9



TILE QUARTER ROUND

- Edge protecting profile for outside corner walls or tiled edges.

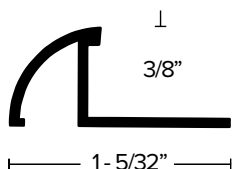

3/8" CERAMIC QUARTER ROUND

ITEM	ITEM DESCRIPTION	COMPARE TO	LENGTH	QTY	WEIGHT
415340	TQ 38 EA	NA	98.5"	12	12
415342	TQ 38 EN	NA	98.5"	12	12

TILE REDUCERS

- Protects edges from chipping or cracking while transitioning tile to another surface or unequal height.
- Allows for straight edge grout line each time

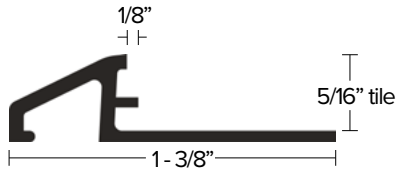

5/16" edgetek TILE REDUCER

ITEM	ITEM DESCRIPTION	COMPARE TO	LENGTH	QTY	WEIGHT
415414	Edgetek U 516 EA	AEU 80	98.5"	12	16
415415	Edgetek U 516 EN	AU 80 AT	98.5"	12	16

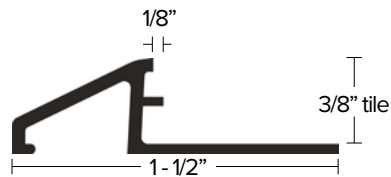

3/8" edgetek TILE REDUCER

ITEM	ITEM DESCRIPTION	COMPARE TO	LENGTH	QTY	WEIGHT
415416	Edgetek U 38 EA	AEU 100	98.5"	12	18
415417	Edgetek U 38 EN	AU 100 AT	98.5"	12	18
415418	Edgetek U 38 BRZ	NA	98.5"	12	18

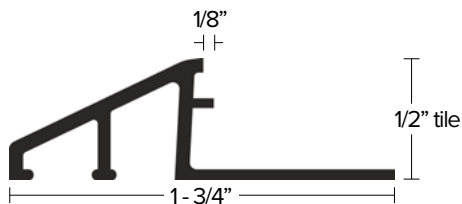

1/2" edgetek TILE REDUCER

ITEM	ITEM DESCRIPTION	COMPARE TO	LENGTH	QTY	WEIGHT
415419	Edgetek U 12 EA	AEU 125	98.5"	12	21
415420	Edgetek U 12 EN	AU 125 AT	98.5"	12	21



TILE TO LVT

- Transition from tile to lower elevation LVT flooring that is already installed.
- Lays over an uneven end of LVT flooring, reduces rework time.

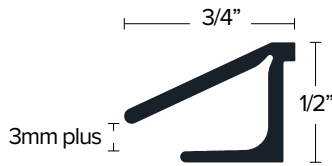

1/2" EXISTING TILE REDUCER

ITEM	ITEM DESCRIPTION	COMPARE TO	LENGTH	QTY	WEIGHT
415501	ETR 38 EA	NA	12'	24	34
415500	ETR 38 EN	NA	12'	24	34
415502	ETR 38 BRZ	NA	12'	24	34

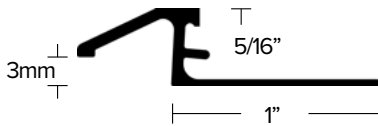

5/16" **edgetek** TILE TO 3MM LVT

ITEM	ITEM DESCRIPTION	COMPARE TO	LENGTH	QTY	WEIGHT
415372	Edgetek TLVT 516 EA	NA	98.5"	12	15
415373	Edgetek TLVT 516 EN	NA	98.5"	12	15

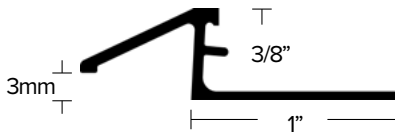

3/8" **edgetek** TILE TO 3MM LVT

ITEM	ITEM DESCRIPTION	COMPARE TO	LENGTH	QTY	WEIGHT
415380	Edgetek TLVT 38 EA	NO	98.5"	12	15
415381	Edgetek TLVT 38 EN	NO	98.5"	12	15
415382	Edgetek TLVT 38 BRZ	NO	98.5"	12	15

CARPET TUCK

- Transitions from tile to carpet

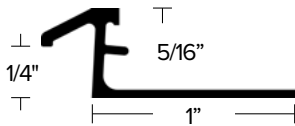

5/16" edgetek[®] CARPET TUCK

ITEM	ITEM DESCRIPTION	COMPARE TO	LENGTH	QTY	WEIGHT
415374	Edgetek CT 516 EA	AETK 80	98.5"	12	12

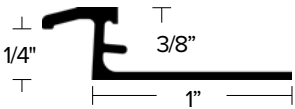

3/8" edgetek[®] CARPET TUCK

ITEM	ITEM DESCRIPTION	COMPARE TO	LENGTH	QTY	WEIGHT
415383	Edgetek CT 38 EA	AETK 100	98.5"	12	13
415384	Edgetek CT 38 EN	ATK 100 AT	98.5"	12	13
415385	Edgetek CT 38 BRZ	NA	98.5"	12	13



ROUND BULL NOSE

- Edge protecting profile for outside corners of tiled surfaces.
- Allows for coordination of finishes within a given area.

5/16" **edgetek** TILE BULL NOSE

ITEM	ITEM DESCRIPTION	COMPARE TO	LENGTH	QTY	WEIGHT
415421	Edgetek R 516 EA	RO 80 AE	98.5"	12	13
415422	Edgetek R 516 EN	RO 80 AT	98.5"	12	13
415423	Edgetek R 516 BBDA	RO 80 ACG	98.5"	12	13
415424	Edgetek R 516 BRZ	NA	98.5"	12	13

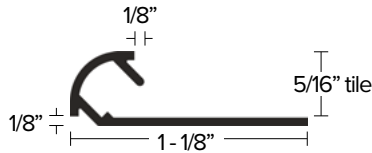

3/8" **edgetek** TILE BULL NOSE

ITEM	ITEM DESCRIPTION	COMPARE TO	LENGTH	QTY	WEIGHT
415425	Edgetek R 38 EA	RO 100 AE	98.5"	12	14
415426	Edgetek R 38 EN	RO 100 AT	98.5"	12	14
415427	Edgetek R 38 BBDA	RO 100 ACG	98.5"	12	14
415428	Edgetek R 38 BRZ	NA	98.5"	12	14

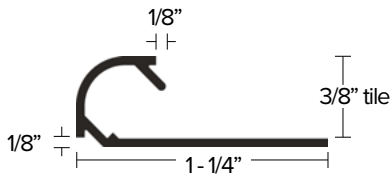

SQUARE CORNER

- Edge protecting profile for outside corner walls of tiled edges.
- Allows for straight edge grout line.

5/16" **edgetek** SQUARE CORNER

ITEM	ITEM DESCRIPTION	COMPARE TO	LENGTH	QTY	WEIGHT
415431	Edgetek Q 516 EA	Q 80 AE	98.5"	12	15
415432	Edgetek Q 516 EN	Q 80 AT	98.5"	12	15
415433	Edgetek Q 516 BBDA	Q 80 ACG	98.5"	12	15
415434	Edgetek Q 516 BRZ	NA	98.5"	12	15

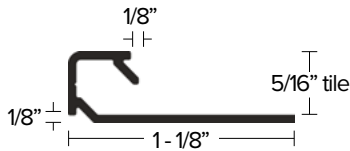

3/8" **edgetek** SQUARE CORNER

ITEM	ITEM DESCRIPTION	COMPARE TO	LENGTH	QTY	WEIGHT
415435	Edgetek Q 38 EA	Q 100 AE	98.5"	12	15
415436	Edgetek Q 38 EN	Q 100 AT	98.5"	12	15
415437	Edgetek Q 38 BBDA	Q 100 ACG	98.5"	12	15
415438	Edgetek Q 38 BRZ	NA	98.5"	12	15

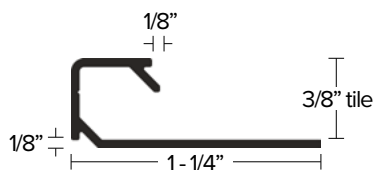

METAL CORNERS

- Aluminum corners for use with ceramic trims.
- Eliminates the need for a mitered edge
- Compatible with Edgetek R and Q profiles



5/16" R CORNER

ITEM	ITEM DESCRIPTION	COMPARE TO	FOR USE WITH	QTY
415700	R Corner 516 EA	RO 80 AE	edgetek R 516 EA	2
415704	R Corner 516 EN	RO 80 AT	edgetek R 516 EN	2
415708	R Corner 516 BRZ	NA	edgetek R 516 BRZ	2



3/8" R CORNER

ITEM	ITEM DESCRIPTION	COMPARE TO	FOR USE WITH	QTY
415702	R Corner 38 EA	RO 100 AE	edgetek R 38 EA	2
415706	R Corner 38 EN	RO 100 AT	edgetek R 38 EN	2
415710	R Corner 38 BRZ	NA	edgetek R 38 BRZ	2

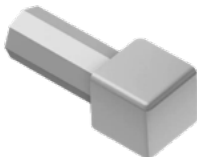

5/16" Q CORNER

ITEM	ITEM DESCRIPTION	COMPARE TO	FOR USE WITH	QTY
415701	Q Corner 516 EA	Q 80 AE	edgetek Q 516 EA	2
415705	Q Corner 516 EN	Q 80 AT	edgetek Q 516 EN	2
415709	Q Corner 516 BRZ	NA	edgetek Q 516 BRZ	2

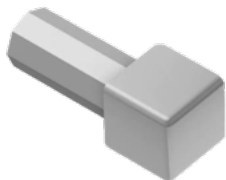

3/8" Q CORNER

ITEM	ITEM DESCRIPTION	COMPARE TO	FOR USE WITH	QTY
415703	Q Corner 38 EA	Q 100 AE	edgetek Q 38 EA	2
415707	Q Corner 38 EN	Q 100 AT	edgetek Q 38 EN	2
415711	Q Corner 38 BRZ	NA	edgetek Q 38 BRZ	2



STAIR NOSING

- Basic nosing for steps.
- Provides finished edge on steps or counter tops.

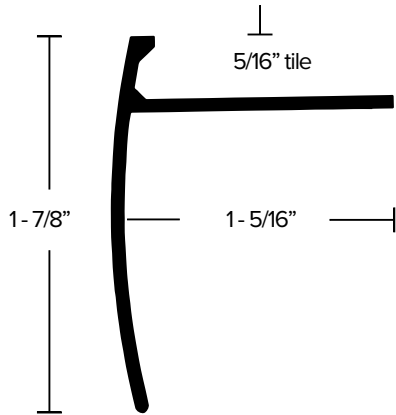

5/16" STAIR NOSING					
ITEM	ITEM DESCRIPTION	COMPARE TO	LENGTH	QTY	WEIGHT
415333	TS 516 EN	NA	98.5"	12	23

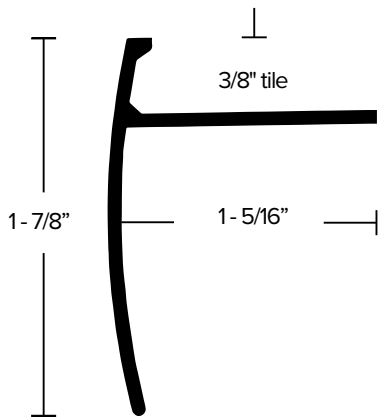

3/8" STAIR NOSING					
ITEM	ITEM DESCRIPTION	COMPARE TO	LENGTH	QTY	WEIGHT
415350	TS 38 EA	NA	98.5"	12	25
415334	TS 38 EN	NA	98.5"	12	25

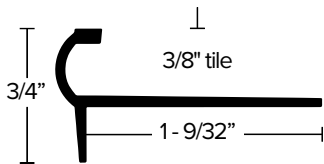

3/8" STAIR NOSING					
ITEM	ITEM DESCRIPTION	COMPARE TO	LENGTH	QTY	WEIGHT
415346	SE 38 EA	NA	98.5"	12	15
415344	SE 38 EN	NA	98.5"	12	15

STEP NOSING

- Profile primarily used on stair edges or counter tops.
- Allows for straight edge grout line.

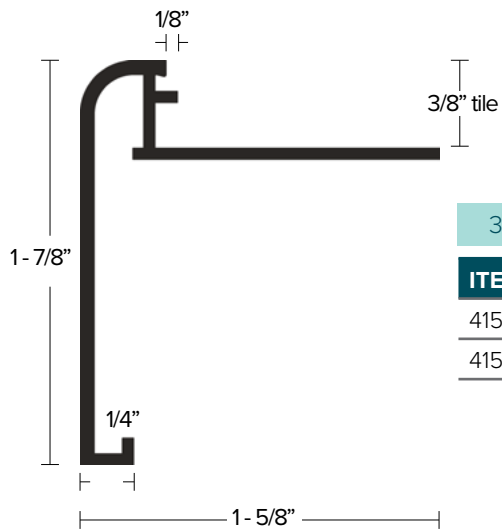

3/8" edgetek[®] STEP

ITEM	ITEM DESCRIPTION	COMPARE TO	LENGTH	QTY	WEIGHT
415429	Edgetek Step 38 EA	RS 100 AE 39	98.5"	12	29
415430	Edgetek Step 38 BRZ	NA	98.5"	12	29

T-SEAM BINDER

- Transitions between 2 ceramic pieces of equal height.
- Prevents tile from chipping and cracking.

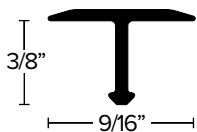

9/16" T-SEAM BINDER

ITEM	ITEM DESCRIPTION	COMPARE TO	LENGTH	QTY	WEIGHT
415265	T 916 EA	NA	98.5"	12	12

VINYL TRIMS



Reducers, joiners, cove, stair nosing and snap-in dividers. A durable, flexible product with a tough matte finish.

COVE STICK

- Used to support sheet vinyl coving
- Made from PVC
- Helps protect flooring from puncture

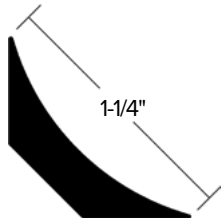

1 - 1/4" COVE STICK

ITEM	ITEM DESCRIPTION	LENGTH	QTY	WEIGHT
460170	VT 051 PVC	5'	120	37

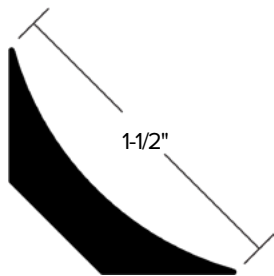

1 - 1/2" COVE STICK

ITEM	ITEM DESCRIPTION	LENGTH	QTY	WEIGHT
460175	VT 052 PVC	5'	80	27

REDUCERS

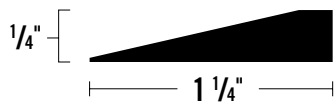

REDUCER FOR GLUE-DOWN CARPET

ITEM	ITEM DESCRIPTION	LENGTH	QTY	WEIGHT
460201	VT 320 BROWN	12'	20	24
460203	VT 320 BEIGE	12'	20	24

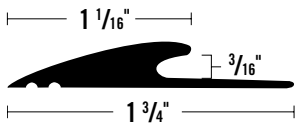

REDUCER FOR GLUE-DOWN CARPET

ITEM	ITEM DESCRIPTION	LENGTH	QTY	WEIGHT
460330	VT 333 BLACK	12'	20	26

► For 3/16" carpet

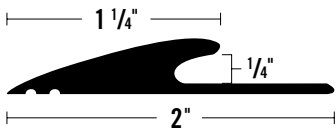

REDUCER FOR GLUE-DOWN CARPET

ITEM	ITEM DESCRIPTION	LENGTH	QTY	WEIGHT
460320	VT 332 BLACK	12'	20	31
460321	VT 332 BROWN	12'	20	31
460322	VT 332 CHARCOAL	12'	20	31
460323	VT 332 BEIGE	12'	20	31

► For 1/4" carpet

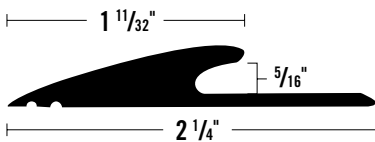

REDUCER FOR GLUE-DOWN CARPET

ITEM	ITEM DESCRIPTION	LENGTH	QTY	WEIGHT
460310	VT 331 BLACK	12'	20	42
460311	VT 331 BROWN	12'	20	42
460312	VT 331 CHARCOAL	12'	20	42

► For 5/16" carpet

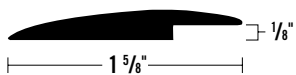

OVER THE TOP RESILIENT REDUCER

ITEM	ITEM DESCRIPTION	LENGTH	QTY	WEIGHT
460260	VT 326 BLACK	12'	20	28
460263	VT 326 CHARCOAL	12'	20	28
460262	VT 326 BEIGE	12'	20	28



TILE REDUCER FOR RESILIENT FLOORS

ITEM	ITEM DESCRIPTION	LENGTH	QTY	WEIGHT
460240	VT 324 BLACK	3'	50	8
460241	VT 324 BROWN	3'	50	8
460242	VT 324 CHARCOAL	3'	50	8
460243	VT 324 BEIGE	3'	50	8



TILE REDUCER FOR RESILIENT FLOORS

ITEM	ITEM DESCRIPTION	LENGTH	QTY	WEIGHT
460250	VT 325 BLACK	3'	50	17
460251	VT 325 BROWN	3'	50	17
460252	VT 325 CHARCOAL	3'	50	17
460253	VT 325 BEIGE	3'	50	17

► With beveled edge for resilient floors



TILE AND CARPET JOINER

ITEM	ITEM DESCRIPTION	LENGTH	QTY	WEIGHT
460540	VT 754 BLACK	12'	20	28
460541	VT 754 BROWN	12'	20	28
460542	VT 754 CHARCOAL	12'	20	28
460543	VT 754 BEIGE	12'	20	28

► For 1/4" tile or carpet

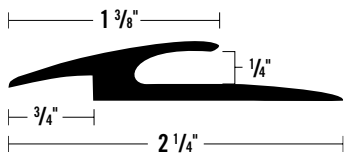

TILE AND CARPET JOINER

ITEM	ITEM DESCRIPTION	LENGTH	QTY	WEIGHT
460550	VT 756 BLACK	12'	20	26
460551	VT 756 BROWN	12'	20	26
460552	VT 756 CHARCOAL	12'	20	26
460553	VT 756 BEIGE	12'	20	26

► For 1/4" tile or carpet

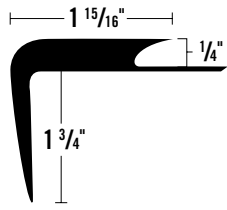

STAIR NOSING

ITEM	ITEM DESCRIPTION	LENGTH	QTY	WEIGHT
460400	VT 640 BLACK	12'	6	43
460401	VT 640 BROWN	12'	6	43

► Heavy duty stair nosing

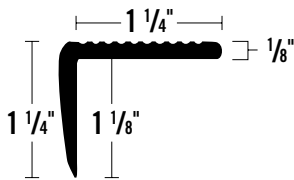

STAIR NOSING

ITEM	ITEM DESCRIPTION	LENGTH	QTY	WEIGHT
460420	VT 642 BLACK	12'	12	23
460421	VT 642 BROWN	12'	12	23
460422	VT 642 CHARCOAL	12'	12	23
460423	VT 642 BEIGE	12'	12	23

► Square top nosing

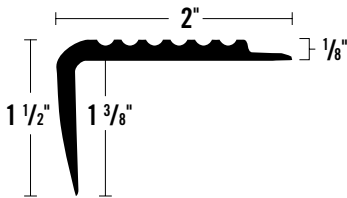

STAIR NOSING

ITEM	ITEM DESCRIPTION	LENGTH	QTY	WEIGHT
460410	VT 641 BLACK	12'	12	42
460411	VT 641 BROWN	12'	12	42
460412	VT 641 CHARCOAL	12'	12	42

► Commercial stair nosing

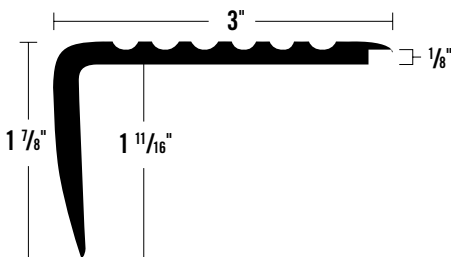

STAIR NOSING

ITEM	ITEM DESCRIPTION	LENGTH	QTY	WEIGHT
460440	VT 644 BLACK	12'	12	78
460441	VT 644 BROWN	12'	12	78
460444	VT 644 BEIGE	12'	12	78

► Overlap nosing for tile and resilient

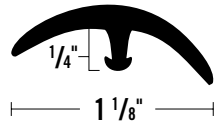

SNAP-IN DIVIDERS AND EDGES

ITEM	ITEM DESCRIPTION	LENGTH	QTY	WEIGHT
460040	VT 704 BLACK	12'	20	21
460041	VT 704 BROWN	12'	20	21
460042	VT 704 CHARCOAL	12'	20	21
460044	VT 704 BEIGE	12'	20	21

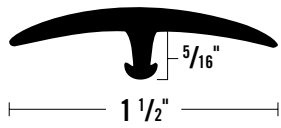

SNAP-IN DIVIDERS AND EDGES

ITEM	ITEM DESCRIPTION	LENGTH	QTY	WEIGHT
460030	VT 703 BLACK	12'	20	27
460031	VT 703 BROWN	12'	20	27
460032	VT 703 CHARCOAL	12'	20	27
460034	VT 703 BEIGE	12'	20	27

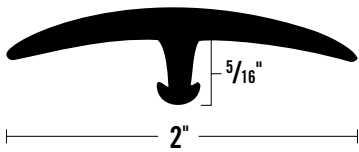

SNAP-IN DIVIDERS AND EDGES

ITEM	ITEM DESCRIPTION	LENGTH	QTY	WEIGHT
460060	VT 706 BEIGE	12'	20	29

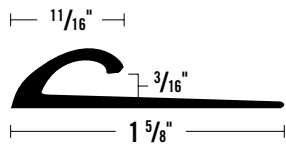

CARPET COVING CAP

ITEM	ITEM DESCRIPTION	LENGTH	QTY	WEIGHT
460103	VT 410 BEIGE	12'	20	22

► Flexible carpet cove cap

FUTURA TRANSITIONS TROWELS



- Over 30 notch types available for use with carpet, ceramic, wood, vinyl and other resilients.
- Balanced for professional use.
- Hardened and tempered steel blade.

TROWEL SPECS

FUTURA TRANSITIONS TROWELS

ITEM	ITEM DESCRIPTION	
Premium Trowels		
020044	FUT TROWEL 4.5x11" 1/16x1/32x5/64 U*	6
020045	FUT TROWEL 4.5x11" 1/4x1/8x1/4 SQ*	6
020046	FUT TROWEL 4.5x11" 3/16x1/4x1/2 V*	6
020047	FUT TROWEL 4.5x14" 1/16x1/32x1/32 U*	6
020048	FUT TROWEL 4.5x14" 1/16x1/16x1/16 SQ*	6
020049	FUT TROWEL 4.5x14" 1/8x1/8x1/16 V*	6
020050	FUT TROWEL 4x16" Pool Finishing*	6
020051	FUT TROWEL 4.5x11" 1/16x1/32x1/32 U*	6
020052	FUT TROWEL 4.5x11" 1/16x1/16x3/32 U*	8
020053	FUT TROWEL 4.5x11" 1/8x1/8x1/16 U*	6
020054	FUT TROWEL 4.5x11" 1/8x3/16x1/8 U*	6
020055	FUT TROWEL 4.5x11" 1/8x1/8x1/8 U*	6
020056	FUT TROWEL 4.5x11" 1/16x1/16x1/16 SQ*	6
020057	FUT TROWEL 4.5x11" 1/8x1/8x1/8 SQ*	6
020058	FUT TROWEL 4.5x11" 3/16x3/16x3/16 SQ*	6
020059	FUT TROWEL 4.5x11" 3/16x5/32 V*	6
020060	FUT TROWEL 4.5x11" 3/32x3/32x3/32 V*	6
020061	FUT TROWEL 4.5x11" 1/8x1/8x1/16 V*	6
020062	FUT TROWEL 4x14" Flat Finishing	6
020097	FUT TROWEL LH 4.5x11" 1/16x1/32x1/32 U*	6
020098	FUT TROWEL LH 4-5x11" 1/16x1/16x1/16 SQ*	6
020099	FUT TROWEL LH 4.5x11" 1/8x1/8x1/16 V*	6
020100	FUT TROWEL 4.5x11" 1/16x1/16x1/16 V*	6
030000	FUT TROWEL 4.5x11" 3/16x1/4x5/16 V*	6
049038	FUT TROWEL 4.5x11" 1/2x1/2x1/2 SQ*	6
049110	FUT TROWEL 4.5x11" 1/4x1/4x1/4 SQ*	6
049112	FUT TROWEL 4.5x11" 1/4x3/8x1/4 SQ*	6
049116	FUT TROWEL 4.5x11" 1/4x3/16 V*	6
049972	FUT TROWEL 4.5x11" 1/4x1/4 V*	6
Economy Trowels		
020063	FUT ECONO TRWL 4x9" 1/16x1/32x1/32 U*	12
020064	FUT ECONO TRWL 4x9" 1/16x1/16x1/16 SQ*	12
049100	FUT ECONO TRWL 4x9" 1/4x1/4x1/4 SQ*	12
049102	FUT ECONO TRWL 4x9" 1/4x3/8x1/4 SQ*	12
049104	FUT ECONO TRWL 4x9" 1/2x1/2x1/2 *SQ	12
049108	FUT ECONO TRWL 4x9" 3/16x5/32 V*	12



PREMIUM TROWELS

- Premium ergonomic handle.
- Rubberized grip for greater control.

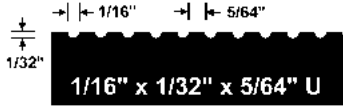

ITEM	NOTCH DESCRIPTION	NOTCH STYLE	BLADE SIZE	BLADE ANGLE	CASE QTY
020044	1/16" x 1/32" x 5/64"	U NOTCH	4-1/2 x 11	15°	6

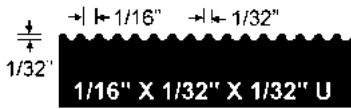

ITEM	NOTCH DESCRIPTION	NOTCH STYLE	BLADE SIZE	BLADE ANGLE	CASE QTY
020051	1/16" x 1/32" x 1/32"	U NOTCH	4-1/2 x 11	15°	6
020097	1/16" x 1/32" x 1/32" LEFT HANDED	U NOTCH	4-1/2 x 11	15°	6
020047	1/16" x 1/32" x 1/32"	U NOTCH	4-1/2 x 14	15°	6

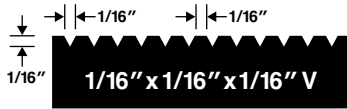

ITEM	NOTCH DESCRIPTION	NOTCH STYLE	BLADE SIZE	BLADE ANGLE	CASE QTY
020100	1/16" x 1/16" x 1/16"	FLAT V NOTCH	4-1/2 x 11	15°	6

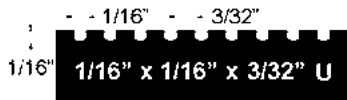

ITEM	NOTCH DESCRIPTION	NOTCH STYLE	BLADE SIZE	BLADE ANGLE	CASE QTY
020052	1/16" x 1/16" x 3/32"	U NOTCH	4-1/2 x 11	15°	6

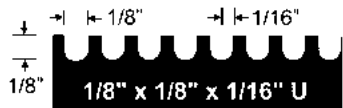

ITEM	NOTCH DESCRIPTION	NOTCH STYLE	BLADE SIZE	BLADE ANGLE	CASE QTY
020053	1/8" x 1/8" x 1/16"	U NOTCH	4-1/2 x 11	15°	6

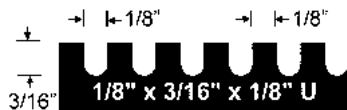

ITEM	NOTCH DESCRIPTION	NOTCH STYLE	BLADE SIZE	BLADE ANGLE	CASE QTY
020054	1/8" x 3/16" x 1/8"	U NOTCH	4-1/2 x 11	15°	6

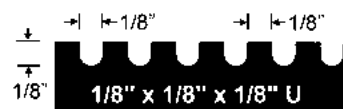

ITEM	NOTCH DESCRIPTION	NOTCH STYLE	BLADE SIZE	BLADE ANGLE	CASE QTY
020055	1/8" x 1/8" x 1/8"	U NOTCH	4-1/2 x 11	15°	6

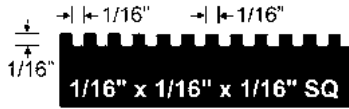

ITEM	NOTCH DESCRIPTION	NOTCH STYLE	BLADE SIZE	BLADE ANGLE	CASE QTY
020056	1/16" x 1/16" x 1/16"	SQUARE NOTCH	4-1/2 x 11	15°	6
020098	1/16" x 1/16" x 1/16" LEFT HANDED	SQUARE NOTCH	4-1/2 x 11	15°	6
020048	1/16" x 1/16" x 1/16"	SQUARE NOTCH	4-1/2 x 14	15°	6

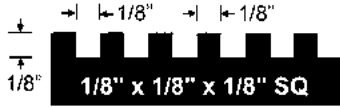

ITEM	NOTCH DESCRIPTION	NOTCH STYLE	BLADE SIZE	BLADE ANGLE	CASE QTY
020057	1/8" x 1/8" x 1/8"	SQUARE NOTCH	4-1/2 x 11	SQUARE	6

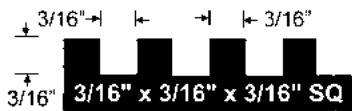

ITEM	NOTCH DESCRIPTION	NOTCH STYLE	BLADE SIZE	BLADE ANGLE	CASE QTY
020058	3/16" x 3/16" x 3/16"	SQUARE NOTCH	4-1/2 x 11	SQUARE	6

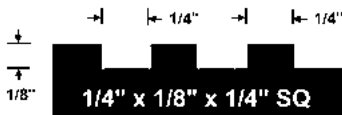

ITEM	NOTCH DESCRIPTION	NOTCH STYLE	BLADE SIZE	BLADE ANGLE	CASE QTY
020045	1/4" x 1/8" x 1/4"	SQUARE NOTCH	4-1/2 x 11	SQUARE	6

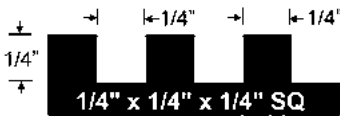

ITEM	NOTCH DESCRIPTION	NOTCH STYLE	BLADE SIZE	BLADE ANGLE	CASE QTY
049110	1/4" x 1/4" x 1/4"	SQUARE NOTCH	4-1/2 x 11	SQUARE	6

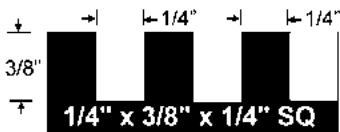

ITEM	NOTCH DESCRIPTION	NOTCH STYLE	BLADE SIZE	BLADE ANGLE	CASE QTY
049112	1/4" x 3/8" x 1/4"	SQUARE NOTCH	4-1/2 x 11	SQUARE	6

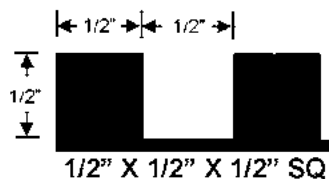

ITEM	NOTCH DESCRIPTION	NOTCH STYLE	BLADE SIZE	BLADE ANGLE	CASE QTY
049038	1/2" x 1/2" x 1/2"	SQUARE NOTCH	4-1/2 x 11	SQUARE	6

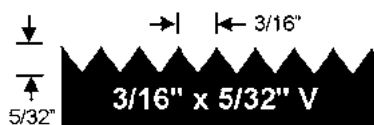

ITEM	NOTCH DESCRIPTION	NOTCH STYLE	BLADE SIZE	BLADE ANGLE	CASE QTY
020059	3/16" x 5/32"	V NOTCH	4-1/2 x 11	SQUARE	6

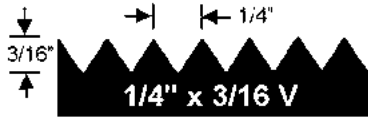

ITEM	NOTCH DESCRIPTION	NOTCH STYLE	BLADE SIZE	BLADE ANGLE	CASE QTY
049116	1/4" x 3/16"	V NOTCH	4-1/2 x 11	SQUARE	6

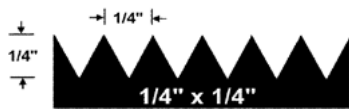

ITEM	NOTCH DESCRIPTION	NOTCH STYLE	BLADE SIZE	BLADE ANGLE	CASE QTY
049972	1/4" x 1/4"	V NOTCH	4-1/2 x 11	SQUARE	6

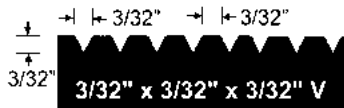

ITEM	NOTCH DESCRIPTION	NOTCH STYLE	BLADE SIZE	BLADE ANGLE	CASE QTY
020060	3/32" x 3/32" x 3/32"	FLAT V NOTCH	4-1/2 x 11	15°	6

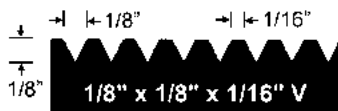

ITEM	NOTCH DESCRIPTION	NOTCH STYLE	BLADE SIZE	BLADE ANGLE	CASE QTY
020061	1/8" x 1/8" x 1/16"	FLAT V NOTCH	4-1/2 x 11	15°	6
020099	1/8" x 1/8" x 1/16" LEFT HANDED	FLAT V NOTCH	4-1/2 x 11	15°	6
020049	1/8" x 1/8" x 1/16"	FLAT V NOTCH	4-1/2 x 14	15°	6

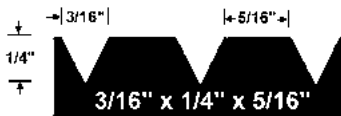

ITEM	NOTCH DESCRIPTION	NOTCH STYLE	BLADE SIZE	BLADE ANGLE	CASE QTY
030000	3/16" x 1/4" x 5/16"	FLAT V NOTCH	4-1/2 x 11	SQUARE	6

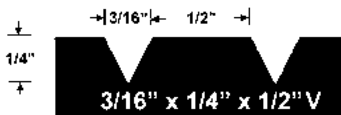

ITEM	NOTCH DESCRIPTION	NOTCH STYLE	BLADE SIZE	BLADE ANGLE	CASE QTY
020046	3/16" x 1/4" x 1/2"	FLAT V NOTCH	4-1/2 x 11	SQUARE	6



ITEM	NOTCH DESCRIPTION	NOTCH STYLE	BLADE SIZE	BLADE ANGLE	CASE QTY
020062	FLAT SMOOTHING	FLAT SMOOTHING	4 x 14	SQUARE	6



ITEM	NOTCH DESCRIPTION	NOTCH STYLE	BLADE SIZE	BLADE ANGLE	CASE QTY
020050	FLAT POOL	FLAT POOL SMOOTHING	4 x 16	ROUND	6

ECONOMY TROWELS

- Durable plastic handle.
- Lower cost

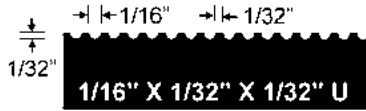
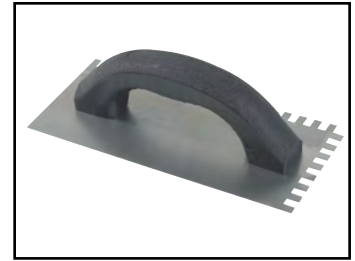

ITEM	NOTCH DESCRIPTION	NOTCH STYLE	BLADE SIZE	BLADE ANGLE	CASE QTY
020063	1/16" x 1/32" x 1/32"	U NOTCH	4 x 9	SQUARE	12

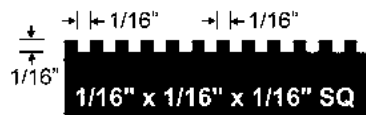

ITEM	NOTCH DESCRIPTION	NOTCH STYLE	BLADE SIZE	BLADE ANGLE	CASE QTY
020064	1/16" x 1/16" x 1/16"	SQUARE NOTCH	4 x 9	SQUARE	12

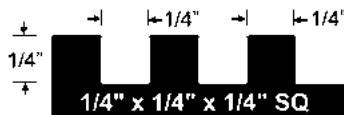

ITEM	NOTCH DESCRIPTION	NOTCH STYLE	BLADE SIZE	BLADE ANGLE	CASE QTY
049100	1/4" x 1/4" x 1/4"	SQUARE NOTCH	4 x 9	SQUARE	12

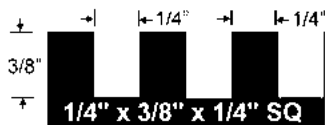

ITEM	NOTCH DESCRIPTION	NOTCH STYLE	BLADE SIZE	BLADE ANGLE	CASE QTY
049102	1/4" x 3/8" x 1/4"	SQUARE NOTCH	4 x 9	SQUARE	12

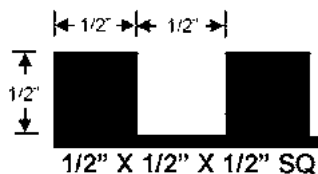

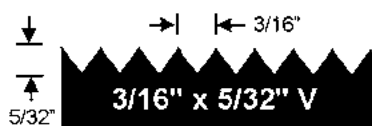

ITEM	NOTCH DESCRIPTION	NOTCH STYLE	BLADE SIZE	BLADE ANGLE	CASE QTY
049104	1/2" x 1/2" x 1/2"	SQUARE NOTCH	4 x 9	SQUARE	12

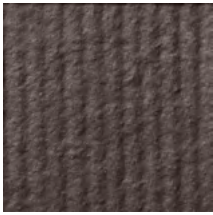

ITEM	NOTCH DESCRIPTION	NOTCH STYLE	BLADE SIZE	BLADE ANGLE	CASE QTY
049108	3/16" x 5/32"	V NOTCH	4 x 9	SQUARE	12

RUBBER BACKED CARPET



Smooth Back
 **020060**
 3/32" x 3/32" x 3/32" V
 120-140 Sq. Ft/Gal. (13 -16 Sq. Yd.)

Rough Back
 **020061**
 1/8" x 1/8" x 1/16" V
 90-110 Sq. Ft/Gal. (10 -12 Sq. Yd.)

SYNTHETIC WOVEN BACKED CARPET

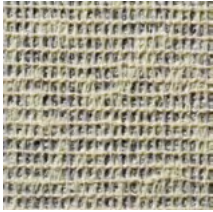

Action-Bac™

 **020061**
 1/8" x 1/8" x 1/16" V
 90-110 Sq. Ft/Gal. (10 -12 Sq. Yd.)

OR
 **020055**
 1/8" x 1/8" x 1/8" U
 90-110 Sq. Ft/Gal. (10 -12 Sq. Yd.)

NON-WOVEN POLYPROPYLENE & NEEDLE-PUNCHED CARPET





Smooth Back
 **020060**
 3/32" x 3/32" x 3/32" V
 120-140 Sq. Ft/Gal. (13 -16 Sq. Yd.)

Rough Back
 **020061**
 1/8" x 1/8" x 1/16" V
 90-110 Sq. Ft/Gal. (10 -12 Sq. Yd.)

LATEX UNITARY BACKED CARPET



Smooth Back
 **020061**
 1/8" x 1/8" x 1/16" V
 90-110 Sq. Ft/Gal. (10 -12 Sq. Yd.)

Rough Back
 **020053**
 1/8" x 1/8" x 1/16" U
 55-65 Sq. Ft/Gal. (6 -7 Sq. Yd.)

DOUBLE GLUE DOWN PAD TO FLOOR





 **020056**
 1/16" x 1/16" x 1/16" SQ
 140 -170 Sq. Ft/Gal. (15 -19 Sq. Yd.)

Permanent Installation
 **020060**
 3/32" x 3/32" x 3/32" V
 120 -140 Sq. Ft/Gal. (13 -16 Sq. Yd.)

DOUBLE GLUE DOWN CARPET TO PAD



Smooth Back
 **020053**
 1/8" x 1/8" x 1/16" U
 55 -65 Sq. Ft/Gal. (6 -7 Sq. Yd.)

Rough Back
 **020054**
 1/8" x 3/16" x 1/8" U
 45 -55 Sq. Ft/Gal. (5 -6 Sq. Yd.)

HOT MELT BACKED CARPET

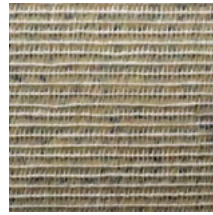

 **020061**
 1/8" x 1/8" x 1/16" V

OR
 **020055**
 1/8" x 1/8" x 1/8" U
 90 -110 Sq. Ft/Gal. (10 -12 Sq. Yd.)

CUSHION BACKED CARPET



Enhancer Plus™

 **020060**
 3/32" x 3/32" x 3/32" V
 120 -140 Sq. Ft/Gal. (13 -16 Sq. Yd.)

MODULAR CARPET TILE

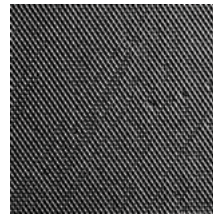

 **020056**
 1/16" x 1/16" x 1/16" SQ
 140-170 Sq. Ft/Gal. (15 -19 Sq. Yd.)

WOVEN CARPET

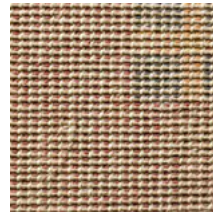

 **020061**
 1/8" x 1/8" x 1/16" V

 **020055**
 1/8" x 1/8" x 1/8" U
 90-110 Sq. Ft/Gal. (10 -12 Sq. Yd.)

VINYL SHEET GOODS HOMOGENEOUS VINYL BACKED

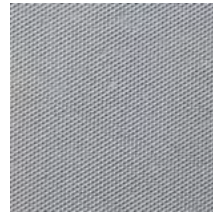

 **020051**
 1/16" X 1/32" X 1/32" U
 Non-Porous Subfloor
 200-240 Sq. Ft/Gal. (22 -26 Sq. Yd.)

 **020056**
 1/16" x 1/16" x 1/16" SQ
 Porous Subfloor
 140 -170 Sq. Ft/Gal. (15 -19 Sq. Yd.)

VINYL COMPOSITION TILE (VCT)



 **020051**
 1/16" X 1/32" X 1/32" U
 Non-Porous Subfloor
 200-240 Sq. Ft/Gal. (22 -26 Sq. Yd.)

 **020056**
 1/16" x 1/16" x 1/16" SQ
 Porous Subfloor
 140-170 Sq. Ft/Gal. (15 -19 Sq. Yd.)

*Illustrations do not represent actual size.

VINYL BACKED CARPET

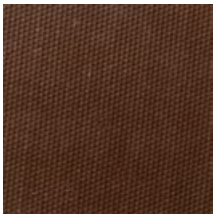

1/16" x 1/16" x 3/32" U **020052**

Non-Porous Subfloor
170 -200 Sq. Ft/Gal. (19 -22 Sq. Yd.)

1/16" x 1/16" x 1/16" SQ **020056**

Porous Subfloor
140 -170 Sq. Ft/Gal. (15 -19 Sq. Yd.)

VINYL SHEET GOODS FELT BACKED

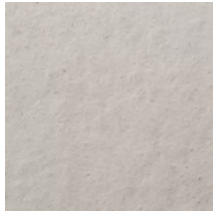

1/16" x 1/16" x 3/32" U **020052**

Non-Porous Subfloor
170 -200 Sq. Ft/Gal. (19 -22 Sq. Yd.)

1/16" x 1/16" x 1/16" SQ **020056**

Porous Subfloor
140 -170 Sq. Ft/Gal. (15 -19 Sq. Yd.)

PRE-FINISHED PARQUET



3/16" x 5/32" V **020059**

50-60 Sq. Ft/Gal. (5-6 Sq. Yd.)

OR

1/8" x 1/8" x 1/8" SQ **020057**

50-60 Sq. Ft/Gal. (5-6 Sq. Yd.)

ENGINEERED WOOD PLANK



1/4" x 3/16" V **049116**

1/4"-5/16" Thick
50-55 Sq. Ft/Gal. (5 -6 Sq. Yd.)

3/16" x 3/16" x 3/16" SQ **020058**

3/8"-9/16" Thick or Less
40-45 Sq. Ft/Gal. (4-5 Sq. Yd.)

1/4" x 1/4" x 1/4" SQ **049110**

≥ 5/8" Thick
30-35 Sq. Ft/Gal. (3-4 Sq. Yd.)

VINYL & RUBBER STAIR TREADS RUBBER RADIAL TILE



1/16" x 1/16" x 3/32" U **020052**

Non-Porous Subfloor
170 -200 Sq. Ft/Gal. (19 -22 Sq. Yd.)

1/16" x 1/16" x 1/16" SQ **020056**

Porous Subfloor
140 -170 Sq. Ft/Gal. (15 -19 Sq. Yd.)

CERAMIC TILE MOSAIC & SMALL FORMAT WALL



1/4" x 3/16" V **049116**

Mastic
50-55 Sq. Ft/Gal. (5 -6 Sq. Yd.)

1/4" x 1/4" x 1/4" SQ **049110**

Thin-Set Mortar
70-90 Sq. Ft/50# Bag

VINYL TILE / VINYL PLANK



1/16" x 1/16" x 3/32" U **020052**

Non-Porous Subfloor
170-200 Sq. Ft/Gal. (19 -22 Sq. Yd.)

1/16" x 1/16" x 1/16" SQ **020056**

Porous Subfloor
140 -170 Sq. Ft/Gal. (15 -19 Sq. Yd.)

WOOD PLANK SOLID



3/16" x 3/16" x 3/16" SQ **020058**

7/16" Thick or Less
40-45 Sq. Ft/Gal. (4 -5 Sq. Yd.)

1/4" x 1/4" x 1/4" SQ **049110**

1/2" Thick or Greater
30-35 Sq. Ft/Gal. (3-4 Sq. Yd.)

CERAMIC TILE SMALL TO MEDIUM FORMAT



1/4" x 1/4" x 1/4" SQ **049110**

Thin-Set Mortar
70 -90 Sq. Ft/50# Bag

CERAMIC TILE MEDIUM TO LARGE FORMAT



1/4" x 3/8" x 1/4" SQ **049112**

Thin-Set Mortar
60 -65 Sq. Ft/50# Bag

CERAMIC TILE LARGE FORMAT & IRREGULAR BACK

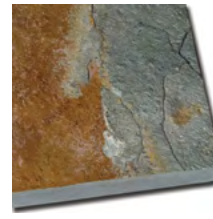

1/2" x 1/2" x 1/2" SQ **049038**

Thin-Set Mortar
25 -35 Sq. Ft/50# Bag

CRACK ISOLATION MAT

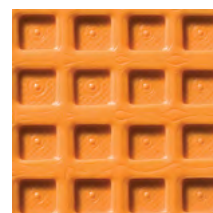

1/4" x 3/16" V **049116**

Thin-Set Mortar
150 -200 Sq. Ft/50# Bag

SPECIALTY MOULDINGS



Versatile finish pieces that add a high end look to both residential and commercial spaces.

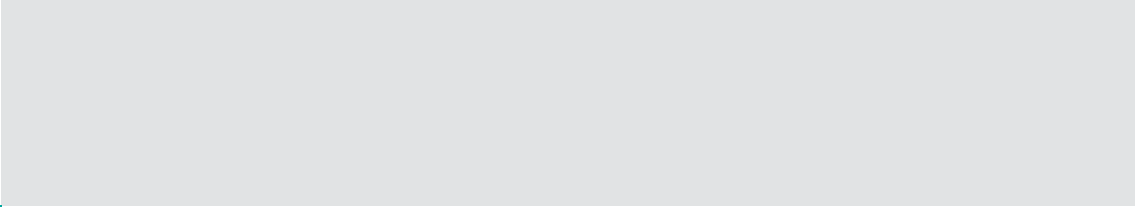

TEE MOULDING

- Versatile metal used for various applications from flooring to door edging.
- Known as Trapdoor Metal.

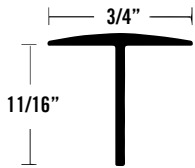
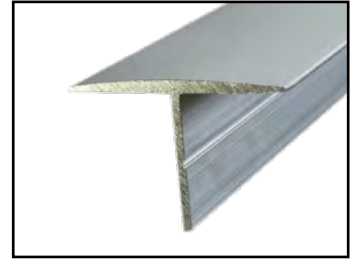

3/4" TEE MOULDING

ITEM	ITEM DESCRIPTION	LENGTH	QTY	WEIGHT
333600	7365 BA	12'	12	16
404160	7365 BB	12'	12	16

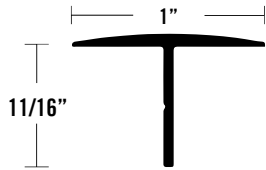

1" TEE MOULDING

ITEM	ITEM DESCRIPTION	LENGTH	QTY	WEIGHT
333692	7395 EA	12'	12	20
333690	7395 BA	12'	12	20
333691	7395 BB	12'	12	20



COUNTERTOP & WALLBOARD CAPS

- Caps or J-bar metal can be used as a decorative edging for a variety of panels that vary in thickness.

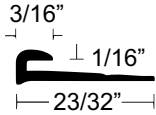

1/16" CAP

ITEM	ITEM DESCRIPTION	LENGTH	QTY	WEIGHT
410800	TM 80 MFA	12'	40	24

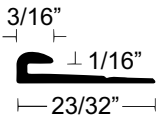

1/16" FLAT BACK CAP

ITEM	ITEM DESCRIPTION	LENGTH	QTY	WEIGHT
410805	TM 81 MFA	12'	40	26

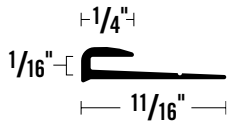

1/16" DEEP SLOT CAP

ITEM	ITEM DESCRIPTION	LENGTH	QTY	WEIGHT
410820	TM 84 MFA	12'	40	26

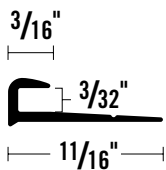

3/32" CAP

ITEM	ITEM DESCRIPTION	LENGTH	QTY	WEIGHT
410815	TM 83 MFA	12'	40	26

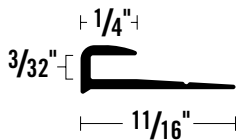

3/32" WIDE FACE CAP

ITEM	ITEM DESCRIPTION	LENGTH	QTY	WEIGHT
410810	TM 82 MFA	12'	40	28
410811	TM 82 MFB	12'	40	28

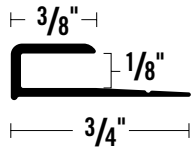

1/8" CAP

ITEM	ITEM DESCRIPTION	LENGTH	QTY	WEIGHT
442086	WB 104 EA	8'	150	84
442085	WB 104 BA	8'	150	84

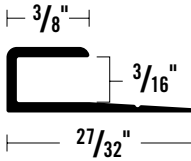

3/16" CAP

ITEM	ITEM DESCRIPTION	LENGTH	QTY	WEIGHT
410720	TM 72 BA	8'	60	28

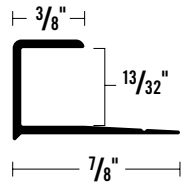

13/32" CAP

ITEM	ITEM DESCRIPTION	LENGTH	QTY	WEIGHT
334190	7524 BA	12'	12	18

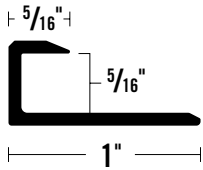

5/16" CAP

ITEM	ITEM DESCRIPTION	LENGTH	QTY	WEIGHT
350018	7358 BBDA	12'	12	18

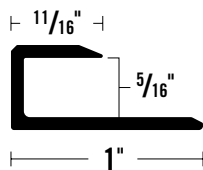

5/16" WIDE FACE CAP

ITEM	ITEM DESCRIPTION	LENGTH	QTY	WEIGHT
350017	7359 BBDA	12'	12	18

COUNTERTOP & WALLBOARD COVES

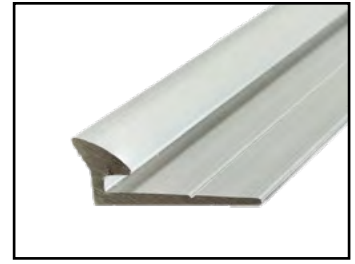

- Coves are applied to a corner when a radius is required on counter tops, wall base, or back splashes.

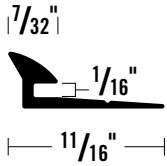

1/16" CAP				
ITEM	ITEM DESCRIPTION	LENGTH	QTY	WEIGHT
410905	TM 91 MFA	12'	40	30
410906	TM 91 MFB	12'	40	30

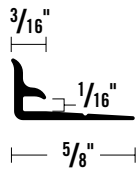

1/16" COVE				
ITEM	ITEM DESCRIPTION	LENGTH	QTY	WEIGHT
410910	TM 92 MFA	12'	40	24
410911	TM 92 MFB	12'	40	24

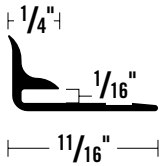

1/16" COVE				
ITEM	ITEM DESCRIPTION	LENGTH	QTY	WEIGHT
410935	TM 98 MFA	12'	40	35

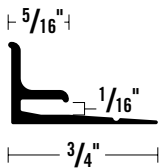

1/16" COVE				
ITEM	ITEM DESCRIPTION	LENGTH	QTY	WEIGHT
410900	TM 90 MFA	12'	40	44

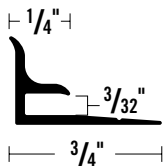

3/32" COVE				
ITEM	ITEM DESCRIPTION	LENGTH	QTY	WEIGHT
410585	TM 85 MFA	12'	40	41

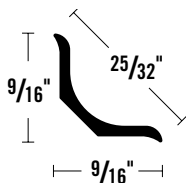

25/32" OFFSET DRILL COVE				
ITEM	ITEM DESCRIPTION	LENGTH	QTY	WEIGHT
410520	TM 52 BA	12'	40	37

COUNTERTOP & WALLBOARD DIVIDERS

- Aluminum dividers are used to join wall, ceiling or floor panels together.

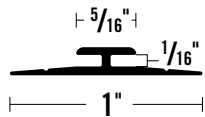

1/16" DIVIDER				
ITEM	ITEM DESCRIPTION	LENGTH	QTY	WEIGHT
410920	TM 94 BA	12'	40	36

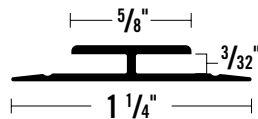

3/32" DIVIDER				
ITEM	ITEM DESCRIPTION	LENGTH	QTY	WEIGHT
442057	WB 110 EA	8'	50	44

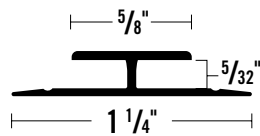

5/32" DIVIDER				
ITEM	ITEM DESCRIPTION	LENGTH	QTY	WEIGHT
442050	WB 103 BA	8'	100	66

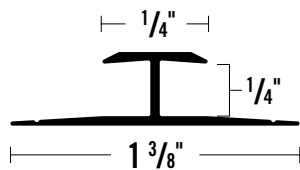

1/4" DIVISION				
ITEM	ITEM DESCRIPTION	LENGTH	QTY	WEIGHT
443010	WB 303 BA	8'	100	85



COUNTERTOP & WALLBOARD OUTSIDE CORNER

- Outside corners can be used with woodworking or finished ceramic edges with a modern sleek look.

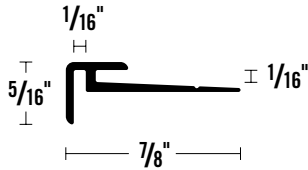

1/16" OUTSIDE CORNER

ITEM	ITEM DESCRIPTION	LENGTH	QTY	WEIGHT
410915	TM 93 BA	12'	40	41

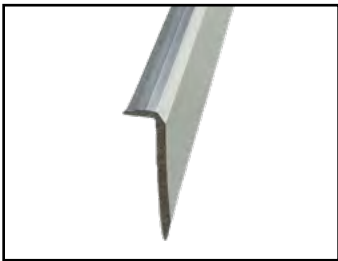

FACING

- Face nosing is used in a wide range of applications from table, counter tops, shelves, or stair tread guarding.

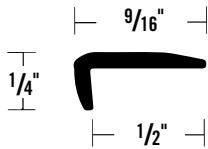

1/2" PLAIN FACING

ITEM	ITEM DESCRIPTION	LENGTH	QTY	WEIGHT
410195	TM 19 BA	12'	40	26
410196	TM 19 BN	12'	24	17

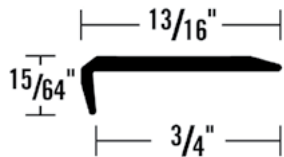

3/4" PLAIN FACING

ITEM	ITEM DESCRIPTION	LENGTH	QTY	WEIGHT
410210	TM 21 BA	12'	40	34

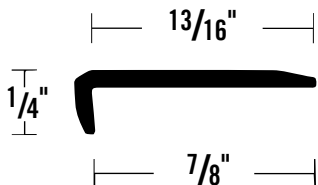

7/8" PLAIN FACING

ITEM	ITEM DESCRIPTION	LENGTH	QTY	WEIGHT
410230	TM 23 BA	12'	40	45

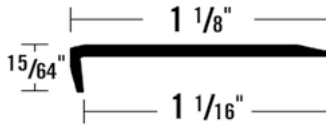

1 - 1/16" PLAIN FACING

ITEM	ITEM DESCRIPTION	LENGTH	QTY	WEIGHT
410250	TM 25 BA	12'	40	46

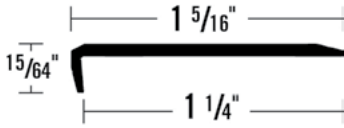

1 - 1/4" PLAIN FACING

ITEM	ITEM DESCRIPTION	LENGTH	QTY	WEIGHT
410240	TM 24 BA	12'	40	53

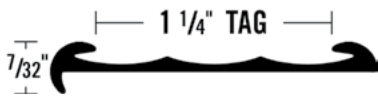

1 - 1/4" PRICE TAG CONVENTIONAL MOULDING

ITEM	ITEM DESCRIPTION	LENGTH	QTY	WEIGHT
331940	0569 BA	12'	12	16

INSERT "T"

- Used for store fixtures, displays and ceramic finishes.
- Can also be used as a ceramic trim to prevent tile edges from chipping or cracking.

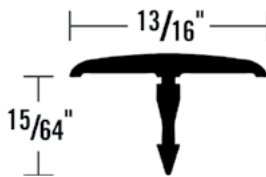

13/16" INSERT OVAL TEE

ITEM	ITEM DESCRIPTION	LENGTH	QTY	WEIGHT
335916	0923 EA	12'	12	17

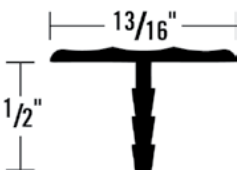

13/16" PALISADE INSERT TEE

ITEM	ITEM DESCRIPTION	LENGTH	QTY	WEIGHT
350027	7364 EA	12'	12	16

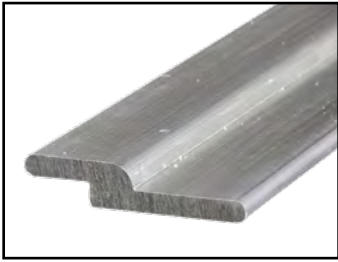

PANEL HANGER

- Ideal for hanging wall panels, frames, or cabinets.
- Easy to install and provides a strong hold



PANEL HANGER				
ITEM	ITEM DESCRIPTION	LENGTH	QTY	WEIGHT
350072	7389 MF	12'	12	32



SLAT WALL PANEL

- Commercial or residential use for displaying or organizing a variety of tools and merchandise.
- Utilizes hooks that allows easy and quick storage options.

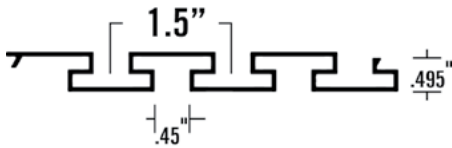

SLAT WALL PANEL				
ITEM	ITEM DESCRIPTION	LENGTH	QTY	WEIGHT
599900	7584 MF	12'	1	9

1/8" FLAT BAR

- Light weight and used for many different fabrication applications.
- Used for framework, braces, supports, and trims

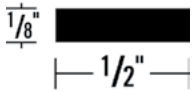
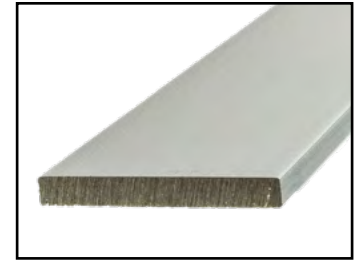

1/2" x 1/8" FLAT BAR				
ITEM	ITEM DESCRIPTION	LENGTH	QTY	WEIGHT
300030	1005 EA	12'	6	8

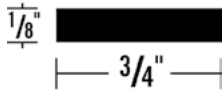

3/4" x 1/8" FLAT BAR				
ITEM	ITEM DESCRIPTION	LENGTH	QTY	WEIGHT
300220	1048 EA	12'	6	11
300225	1048 MF	12'	50	71

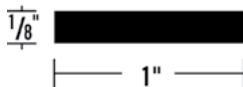

1" x 1/8" FLAT BAR				
ITEM	ITEM DESCRIPTION	LENGTH	QTY	WEIGHT
300020	1004 EA	12'	6	14

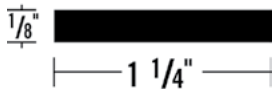

1 - 1/4" x 1/8" FLAT BAR				
ITEM	ITEM DESCRIPTION	LENGTH	QTY	WEIGHT
300306	1068 EA	12'	6	17

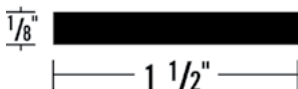

1 - 1/2" x 1/8" FLAT BAR				
ITEM	ITEM DESCRIPTION	LENGTH	QTY	WEIGHT
300228	1049 EA	12'	6	19

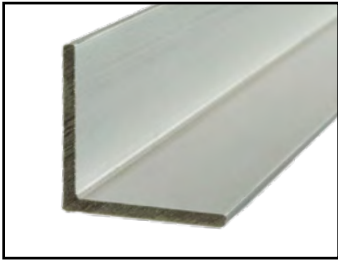

ANGLE

- Angles come in a variety of different sizes for all applications.
- Used for constructing frames, bases, table tops, and counter top edging
- Applications range from decorative moldings, trims, and corners.

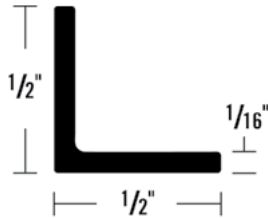

1/2" EQUAL ANGLE

ITEM	ITEM DESCRIPTION	LENGTH	QTY	WEIGHT
276001	3141 EA	8'	6	6
306001	3141 EA	12'	6	8

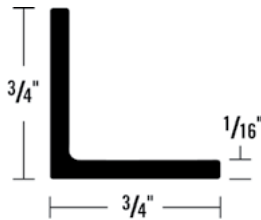

3/4" EQUAL ANGLE

ITEM	ITEM DESCRIPTION	LENGTH	QTY	WEIGHT
276051	3151 EA	8'	6	8
306051	3151 EA	12'	6	11

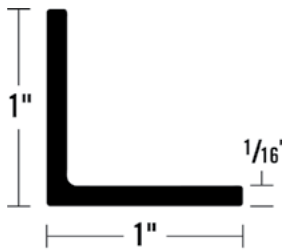

1" EQUAL ANGLE

ITEM	ITEM DESCRIPTION	LENGTH	QTY	WEIGHT
276101	3161 EA	8'	6	13
306101	3161 EA	12'	6	13



3/4" x 3/8" ANGLE

ITEM	ITEM DESCRIPTION	LENGTH	QTY	WEIGHT
302651	1750 EA	12'	6	11



3/4" x 1/2" ANGLE

ITEM	ITEM DESCRIPTION	LENGTH	QTY	WEIGHT
300651	1225 EA	12'	6	8

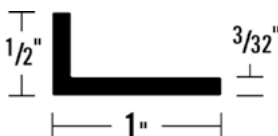

1" x 1/2" ANGLE

ITEM	ITEM DESCRIPTION	LENGTH	QTY	WEIGHT
300158	1033 EA	12'	6	14

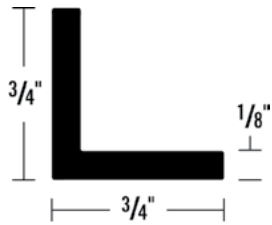

3/4" EQUAL ANGLE

ITEM	ITEM DESCRIPTION	LENGTH	QTY	WEIGHT
300083	1017 EA	12'	6	18

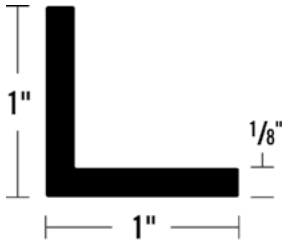

1" EQUAL ANGLE

ITEM	ITEM DESCRIPTION	LENGTH	QTY	WEIGHT
300091	1018 EA	12'	6	23
350053	1018 MF	12'	6	23

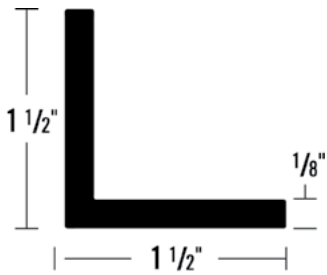

1 - 1/2" EQUAL ANGLE

ITEM	ITEM DESCRIPTION	LENGTH	QTY	WEIGHT
300110	1022 EA	12'	6	34

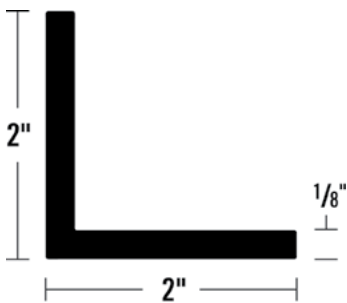

2" EQUAL ANGLE

ITEM	ITEM DESCRIPTION	LENGTH	QTY	WEIGHT
300450	1137 EA	12'	6	45

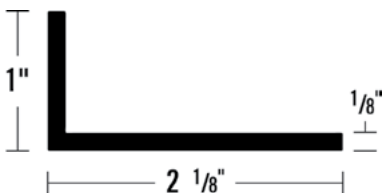

2 - 1/8" X 1" ANGLE

ITEM	ITEM DESCRIPTION	LENGTH	QTY	WEIGHT
300751	1249 EA	12'	6	35



CHANNEL

- Channels come in a variety of different sizes for all applications.
- Channels are perfect for framing and protecting edges.
- Store display, fixtures, glass and window applications.

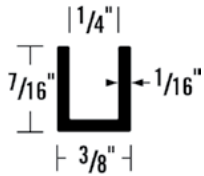

7/16" X 1/4" CHANNEL

ITEM	ITEM DESCRIPTION	LENGTH	QTY	WEIGHT
301151	1347 EA	12'	6	9

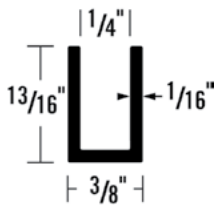

13/16" X 1/4" CHANNEL

ITEM	ITEM DESCRIPTION	LENGTH	QTY	WEIGHT
304001	2223 EA	12'	6	13

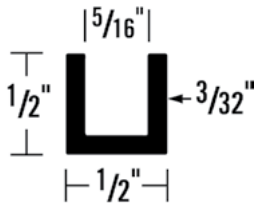

1/2" X 5/16" CHANNEL

ITEM	ITEM DESCRIPTION	LENGTH	QTY	WEIGHT
300178	1038 EA	12'	6	14

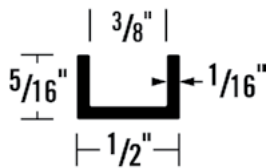

5/16" X 3/8" CHANNEL

ITEM	ITEM DESCRIPTION	LENGTH	QTY	WEIGHT
300895	1285 EA	12'	6	8

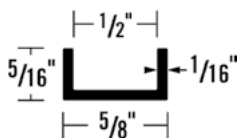

5/16" X 1/2" CHANNEL

ITEM	ITEM DESCRIPTION	LENGTH	QTY	WEIGHT
301201	1362 EA	12'	6	9

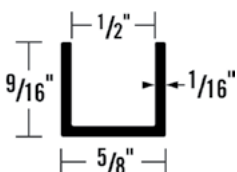

9/16" X 1/2" CHANNEL

ITEM	ITEM DESCRIPTION	LENGTH	QTY	WEIGHT
301143	1346 EA	12'	6	12

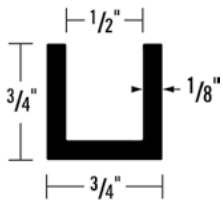

3/4" X 1/2" CHANNEL

ITEM	ITEM DESCRIPTION	LENGTH	QTY	WEIGHT
301901	1538 EA	12'	6	25

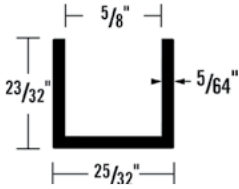

23/32" X 5/8" CHANNEL

ITEM	ITEM DESCRIPTION	LENGTH	QTY	WEIGHT
301139	1345 EA	12'	6	17

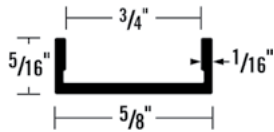

5/16" X 3/4" CHANNEL

ITEM	ITEM DESCRIPTION	LENGTH	QTY	WEIGHT
303751	2161 EA	12'	6	10

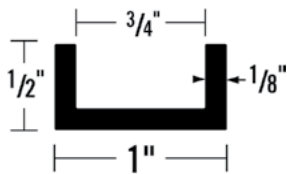

1/2" X 3/4" CHANNEL

ITEM	ITEM DESCRIPTION	LENGTH	QTY	WEIGHT
300187	1040 EA	12'	6	22

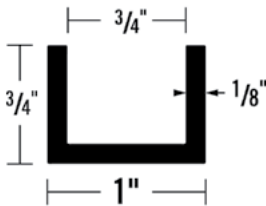

3/4" X 3/4" CHANNEL

ITEM	ITEM DESCRIPTION	LENGTH	QTY	WEIGHT
302501	1710 EA	12'	6	27

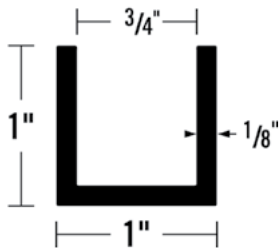

1" X 3/4" CHANNEL

ITEM	ITEM DESCRIPTION	LENGTH	QTY	WEIGHT
300191	1041 EA	12'	6	33

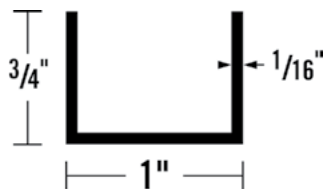

1" X 3/4" TOP CHANNEL

ITEM	ITEM DESCRIPTION	LENGTH	QTY	WEIGHT
350042	7347 EA	12'	6	16

Warranty

Seller warrants that the product(s) supplied by Seller shall be free from defects in workmanship and material and shall conform to the descriptions and specifications, if any, set forth or incorporated by reference in this Agreement. The foregoing warranty only applies to the quality of the goods at the time of delivery, and Seller makes no representation as to the durability or service life of the product. **SELLER DISCLAIMS ANY OTHER WARRANTY, EXPRESS OR IMPLIED, WHETHER CREATED BY CONTRACT, BY STATUTE OR OTHERWISE BY OPERATION OF LAW, INCLUDING ALL WARRANTIES OF MERCHANTABILITY AND FITNESS FOR A PARTICULAR PURPOSE.**

Aluminum Material Information

- Futura Transitions items are extruded in the USA by Bonnell Aluminum with various 6000 series alloys.
- Bonnell Aluminum is ISO 9001: 2015 Certified.
- Futura Transitions products are made from conflict-free materials.
- Futura Transitions products are ROHS and REACH compliant.
- Futura Transitions products are free of hazardous materials and do not require an MSDS.

Aluminum Maintenance

- Futura Transitions aluminum trims and transitions can be cleaned with non-abrasive, non-harsh chemical cleaning products. Test a small section of the aluminum to ensure that any cleaner to be used will not adversely affect the appearance of the metal.



Futura Transitions
Bldg. H-11 Freeport Center
PO Box 160350
Clearfield, UT 84016

800 824 2049
futura.transitions@bonnellaluminum.com
www.futura.transitions.com



FUTURA

TRANSITIONS

by **Bonnell Aluminum**

BONNELL ALUMINUM

Bldg. H-11 Freeport Center

Post Office Box 160350

Clearfield, UT 84016

www.futuratransitions.com

800.824.2049